

SCTE[®] | STANDARDS

Digital Video Subcommittee

SCTE STANDARD

SCTE 55-1 2019 (R2024)

**Digital Broadband Delivery System:
Out of Band Transport Part 1: Mode A**

NOTICE

The Society of Cable Telecommunications Engineers (SCTE) Standards and Operational Practices (hereafter called “documents”) are intended to serve the public interest by providing specifications, test methods and procedures that promote uniformity of product, interoperability, interchangeability, best practices, and the long term reliability of broadband communications facilities. These documents shall not in any way preclude any member or non-member of SCTE from manufacturing or selling products not conforming to such documents, nor shall the existence of such standards preclude their voluntary use by those other than SCTE members.

SCTE assumes no obligations or liability whatsoever to any party who may adopt the documents. Such adopting party assumes all risks associated with adoption of these documents and accepts full responsibility for any damage and/or claims arising from the adoption of such documents.

NOTE: The user’s attention is called to the possibility that compliance with this document may require the use of an invention covered by patent rights. By publication of this document, no position is taken with respect to the validity of any such claim(s) or of any patent rights in connection therewith. If a patent holder has filed a statement of willingness to grant a license under these rights on reasonable and nondiscriminatory terms and conditions to applicants desiring to obtain such a license, then details may be obtained from the standards developer. SCTE shall not be responsible for identifying patents for which a license may be required or for conducting inquiries into the legal validity or scope of those patents that are brought to its attention.

Patent holders who believe that they hold patents which are essential to the implementation of this document have been requested to provide information about those patents and any related licensing terms and conditions. Any such declarations made before or after publication of this document are available on the SCTE web site at <https://scte.org>.

All Rights Reserved

© 2024 Society of Cable Telecommunications Engineers, Inc.

140 Philips Road

Exton, PA 19341

Document Tags

<input checked="" type="checkbox"/> Specification	<input type="checkbox"/> Checklist	<input type="checkbox"/> Facility
<input type="checkbox"/> Test or Measurement	<input type="checkbox"/> Metric	<input checked="" type="checkbox"/> Access Network
<input type="checkbox"/> Architecture or Framework	<input type="checkbox"/> Cloud	<input checked="" type="checkbox"/> Customer Premises
<input type="checkbox"/> Procedure, Process or Method		

Document Release History

Release	Date
SCTE 55-1 2002	2002
SCTE 55-1 2009	2009
SCTE 55-1 2019	2019
SCTE 55-1 2019 (R2024)	4/29/2024

Note: Standards that are released multiple times in the same year use: a, b, c, etc. to indicate normative balloted updates and/or r1, r2, r3, etc. to indicate editorial changes to a released document after the year.

This document is identical to SCTE 55-1 2019 except for informative components which may have been updated such as the title page, NOTICE text, headers and footers. No normative changes have been made to this document

TABLE OF CONTENTS

1. INTRODUCTION	1
2. ACRONYMS	3
3. REFERENCES	5
4. COMPLIANCE NOTATION.....	6
5. OUT-OF-BAND SYSTEM SPECIFICATIONS.....	7
6. PHYSICAL LAYER SPECIFICATION.....	8
6.1. PHYSICAL LAYER FOR OOB TRANSMISSION	8
6.1.1. OOB Transmission Format.....	8
6.1.2. OOB Coding Scheme.....	8
6.1.3. OOB QPSK Mapping.....	12
6.1.4. OOB Modulator RF Output.....	13
6.1.5. OOB Carrier Input Power at Receiver.....	13
6.2. PHYSICAL LAYER FOR RETURN-PATH TRANSMISSION	14
6.2.1. Return-Path Modem Description.....	14
6.2.2. RF Return Path Packet Format.....	14
6.2.3. RF Return-Path Forward Error Correction.....	14
6.2.4. RF Return-Path Randomizer.....	14
6.2.5. RF Return Path Modulator.....	15
6.2.6. RF Return-Path Demodulator Specification.....	16
6.3. EXTENDED PRACTICE FOR RETURN-PATH TRANSMISSION	17
7. DATA LINK LAYER.....	19
7.1. APPLICATION PDU PROCESSING	19
7.2. LINK LAYER HEADERS/TRAILERS	22
7.2.1. Upstream Link Layer Header	22
7.2.2. Padding.....	23
7.2.3. Downstream Link Layer Header	23
7.2.4. Upstream CRC Function	23
7.2.5. Downstream CRC Function.....	23
7.2.6. Acknowledgment protocol	24
7.3. SEGMENTATION AND RE-ASSEMBLY	25
7.3.1. Upstream	25
7.3.2. Downstream.....	25
7.3.3. Maximum PDU Sizes.....	25
7.4. MAC INFORMATION TRANSPORT.....	26
7.4.1. Downstream MAC Message Format.....	26
7.4.2. Upstream Packet Format.....	28
7.5. MAC SIGNALING MESSAGES	31
7.5.1. MAC Signaling Message Encapsulation.....	31
7.5.2. MAC Signaling Message Format.....	32
7.5.3. ALOHA MAC Messages	33

1. INTRODUCTION

This document is identical to SCTE 55-1 2009 except for informative components which may have been updated such as the title page, NOTICE text, headers and footers. No normative changes have been made to this document.

This contribution is a derivative work created from DVS/110. The intention of this document is to provide a contribution whose scope is limited to the physical layer specification for Out-Of-Band cable system. Specifications of MAC Layer and Link Layer are also provided for the Aloha implementation. The latter should be updated in the future, recognizing the potential adaptation of DOCSIS MAC Layer Specification [3].

Revision History

Revision	Date	Editor	DESCRIPTION
Initial Release	August 26, 1998		General Instrument's Implementation Specification of the Digital Broadband Delivery System: Out-of-Band Transport
0	August 26, 1999	N. N. Y. Chu	<ol style="list-style-type: none"> 1. Removal of Upstream CNR for both QPSK and 16-QAM definition for AWGN in Table 10, 2. Labeled Data Link Layer Section as informative, 3. Updated Reference to the latest DOCSIS version, 4. Added Acronyms and References Sections, 5. Unified format presentations for Data Link Layer messages, 6. Overall editorial improvements for ease-of-reading.
1	September 10, 1999	N. N. Y. Chu	<ol style="list-style-type: none"> 1. Added Revision History in Section 1, 2. Incorporated comments from Reviewing Conference Call conducted on September 9, 1999, 3. Re-ordered Physical Layer to Section 5 and Data Link Layer to Section 6.
2	February 25, 2000	N. N. Y. Chu	<ol style="list-style-type: none"> 1. Appended title with Mode A, removing specific reference to General Instrument, 2. Updated Data Link Layer based on Aloha Implementation, 3. Incorporated comments from DVS ballot results.

3	March 11, 2008	Chris Stone	<ol style="list-style-type: none">1. Updated OOB randomizer in section 6.1.2.1.2. Corrected CRC polynomial in sections 7.2.4 and 7.2.5.3. Updated references in section 3.0.
---	----------------	-------------	--

2. ACRONYMS

AAL	ATM Adaptation Layer
AWGN	Additive White Gaussian Noise
ATM	Asynchronous Transfer Mode
BW	BandWidth
CBD	Connection Block Descriptor
CRC	Cyclic Redundancy Check
CW	ClockWise
DAVIC	Digital Audio Video Council
DCM	Default Configuration Message
DLL	Data Link Layer
DOCSIS	Data Over Cable System Interface Specification
FEC	Forward Error Correction
GF	Galois Field
IB	In-Band
IBTM	In-Band Timebase Message
ID	IDentification
IE	Information Element
IP	Internet Protocol
LFSR	linear Feedback Shift Register
MAC	Media Access Control
MAP	Map of Bandwidth Allocation
Mbps	Mega bits per second
Msps	Mega symbols per second
MCNS	Multimedia Cable Network System
MPEG	Motion Picture Expert Group
NRC	Network Related Control
OBTM	Out-of-Band Timebase Message
OOB	Out-Of-Band
PDU	Protocol Data Unit

PER	Packet Error Rate
PN	Pseudo-random Number
PT	Payload Type
QAM	Quadrature Amplitude Modulation
QPSK	Quaternary Phase Shift Keying
R-S	Reed-Solomon Coding
SDU	Service Data Unit
SER	Symbol Error Rate
TDMA	Time Division Multiple Access
TS	Transport Stream
UPM	UPstream MAC

3. REFERENCES

1. IEEE Std 802-1990, Local and Metropolitan Area Networks: Overview and Architecture, and ISO/IEC 10039:1991 Information Technology, Open Systems Interconnection, Local Area Networks, Medium Access Control (MAC) Service Definition.
2. ITU-T Recommendation H.222.0 | ISO/IEC 13818-1: 2007, Information Technology – Generic Coding of Moving Pictures and Associated Audio Information Systems.
3. CableLabs, Data-Over-Cable-Service Interface Specifications (DOCSIS): Radio Frequency Interface Specification, SP-RFIV1.1.I01-990311 (1999).
4. Digital Audio Visual Council 1.4 Specification Part 8, “Lower Layer Protocols and Physical Interfaces” (<http://www.davic.org>).
5. Clark, G. C. and Cain, J. B. (1981): Error-Correction Coding for Digital Communications, Plenum Press.

4. COMPLIANCE NOTATION

“SHALL”	This word or the adjective “REQUIRED” means that the item is an absolute requirement of this specification.
“SHALL NOT”	This phrase means that the item is an absolute prohibition of this specification.
“SHOULD”	This word or the adjective “RECOMMENDED” means that there may exist valid reasons in particular circumstances to ignore this item, but the full implications should be understood and the case carefully weighted before choosing a different course.
“SHOULD NOT”	This phrase means that there may exist valid reasons in particular circumstances when the listed behavior is acceptable or even useful, but the full implications should be understood and the case carefully weighed before implementing any behavior described with this label.
“MAY”	This word or the adjective “OPTIONAL” means that this item is truly optional. One vendor may choose to include the item because a particular marketplace requires it or because it enhances the product, for example; another vendor may omit the same item.

5. OUT-OF-BAND SYSTEM SPECIFICATIONS

This document specifies the Physical Layer and the Data Link Layer (including the MAC Layer) of the Out-Of-Band cable system transport. Section 5 describes the Physical Layer protocol. Section 6 describes the Data Link Layer protocol.

The MAC Layer specification refers to the DOCSIS [3]. However, not all DOCSIS specifications for the MAC Layer are required. The minimum set is specified. Future enhancements toward full DOCSIS compliance are expected based on customers' input.

This specification assumes that the reader has some:

1. fundamental understanding of the conventional cable frequency plan, and
2. familiarity with the Ethernet specification and the Reed-Solomon Coding of Error Correction Schemes.

Also use of the references denoted in Section 3 are highly recommended for a full understanding of this specification.

6. PHYSICAL LAYER SPECIFICATION

This section describes the physical layer of the Out-Of-Band downstream and upstream channels.

6.1. PHYSICAL LAYER FOR OOB TRANSMISSION

The aggregate information rate of the Out-Of-Band (OOB) channel is 2.048 Mbps. Up to 1.544 Mbps may be utilized for access control and other control information as well as application data, application program downloads, program guides, etc. The OOB data channel provides continuous communication from a headend to the Digital Terminals. The Digital Terminal typically remains powered-up even when it is in the “off” state. The OOB channel remains active independent of the tuned video channel, whether the received TV channel is analog or digital, and whether the Digital Terminal box is turned “on” or “off”. Thus, whenever the Digital Terminal connected to the coaxial cable and AC power, the OOB channel is active for downstream communication.

6.1.1. OOB TRANSMISSION FORMAT

The following table summarizes the physical attributes of the OOB channel.

Parameter Name	Specifications
Modulation:	QPSK, differential coding for 90° phase invariance
Symbol Rate:	1.024 Msps
Symbol Size:	2-bits per symbol
Channel Spacing (BW):	1.8 MHz
Transmission Frequency Band:	70 to 130 MHz
Carrier Center Frequency (default):	75.25 ¹ MHz ± 0.01%
Data Rate:	2.048 Mbps ± 0.01%
Forward Error Correction:	96,94 Reed-Solomon block code, T=1, 8bit symbols
FEC Framing	Locked to MPEG-TS, two FEC blocks per MPEG packet
Interleaving	Convolutional, (96,8)
Nominal Information Rate:	2.005 Mbps (132.8 b/s margin)
Frequency Response:	Raised Cosine filter, $\alpha = 0.5$ (receiver only)

1. Other possible OOB carrier center frequencies are 72.75 MHz and 104.2 MHz.

Table 1: Out-Of-Band Transmission Specifications

The OOB channel spacing is 1.8 MHz with frequency step size of 50 kHz. The center frequency for the downstream cable frequency plan can be between 70 to 130 MHz, with 75.25 MHz as the default value.

6.1.2. OOB CODING SCHEME

The forward-error-correction scheme for the OOB channel is composed of the randomization, Reed-Solomon (R-S) coding, and interleaving layers as shown in Figure 1.

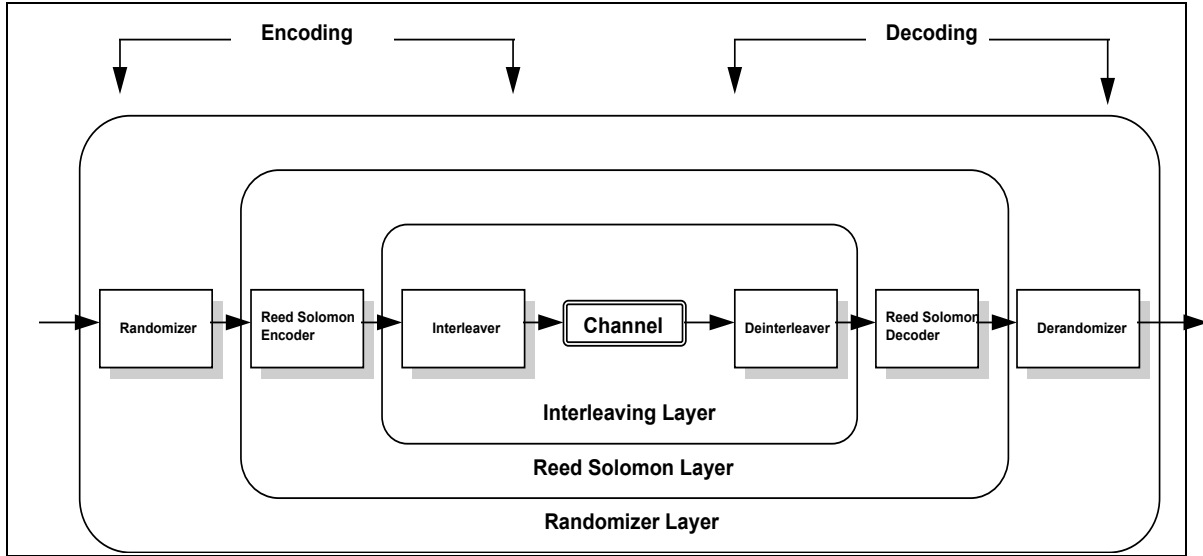

Figure 1: A Block Diagram for Layers of Coding in the OOB Channel

6.1.2.1. OOB RANDOMIZER

The MPEG-TS is randomized to ensure balanced modulation by removing unequal excitation of the QPSK modulation states. The randomizer circuit performs the exclusive OR function on the input MPEG transport sequence with the randomizer's Pseudo-random Number (PN) generator output sequence. The randomization frame consists of two MPEG packets with the randomizer PN generator pre-set at the start of every second MPEG-TS packet. Alternate MPEG-TS Sync bytes are converted from 0x47 to 0x64 by the randomizer. This improves receiver synchronization performance.

The randomizer PN generator is a 13-bit Linear Feedback Shift Register (LFSR) as shown in Figure 2. Binary arithmetic XOR gates and taps are placed at the output of stages 13, 11, 10, and 1. The shift register is preset with a seed value. The stages 10 and 1 are loaded with a seed value of "1" and all other stages, 2 through 9 and 11 through 13 are loaded with a seed value of "0". The seed corresponds to 0x0201. The corresponding generating polynomial is defined as:

$$f(X) = X^{13} + X^{12} + X^{10} + X^9 + 1$$

The randomizer PN generator is preset to the seed value on the 385th byte after clocking for a total of 384 bytes. The MPEG Sync byte 0x47 is converted to 0x64 on the 193rd byte by being exclusive OR'd with the 193rd PN generator output byte output which is 0x23. The randomizing action is gated out during bytes 95-96, 191-192, 287-288 and 383-384. The reason for these gaps in the randomization process is to permit the insertion of Reed Solomon parity bytes. The PN generator continues to run during these gaps but the output is not used. The RS bytes are inserted without being randomized.

The same circuit is used for de-randomizing the received MPEG-TS packets. The sync symbol of the first MPEG-TS packet in a frame remains 0x47 after randomization because the first randomizer output byte after reset is "0x00". The second MPEG-2 Sync byte is changed by the randomizer but will be returned to the MPEG-TS standard value 0x47 by the de-randomizer at the receive site.

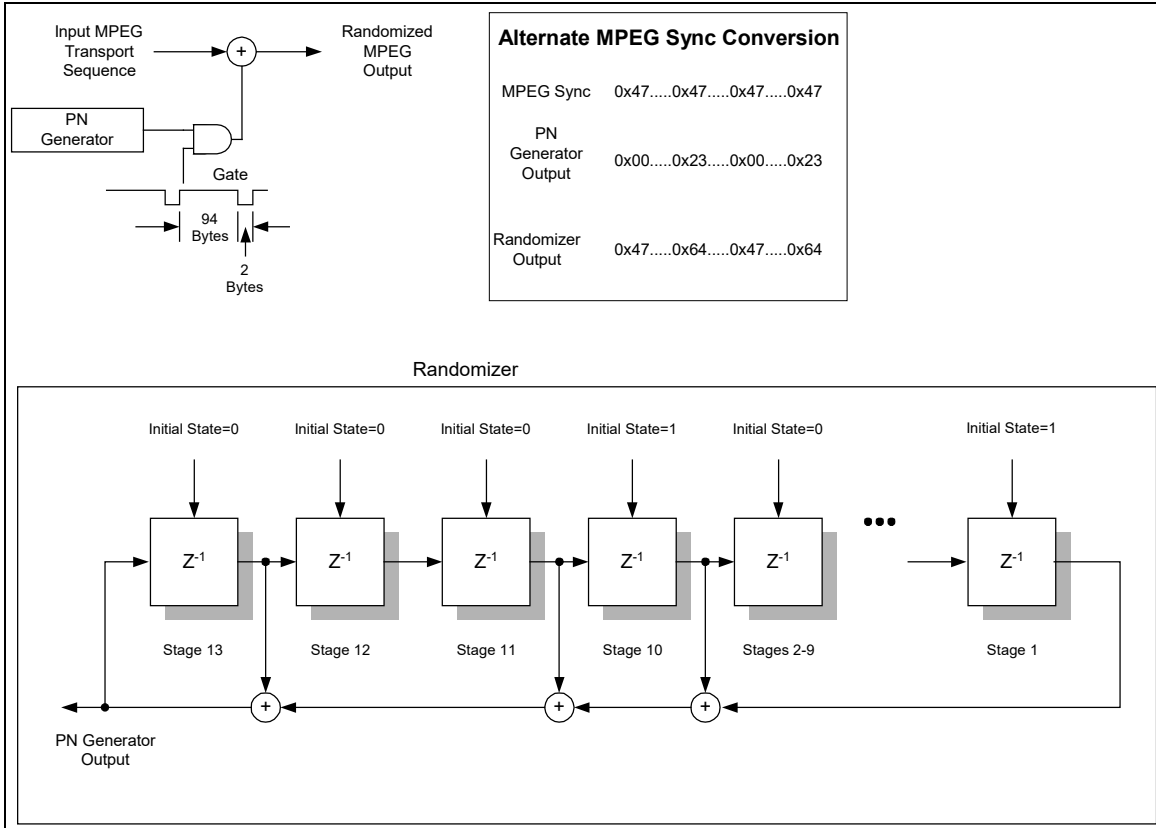

Figure 2: The Out-Of-Band Randomizer

6.1.2.2. FORWARD ERROR CORRECTION CODE

The forward-error-correction (FEC) code in the OOB transmission system is a Reed-Solomon (R-S) block code [5] No codeword shortening and padding is used with the R-S coding. No convolutional coding is required for the relatively robust QPSK transmission on cable-TV transmission networks. The FEC scheme uses (94,96) Reed-Solomon code defined over Galois Field GF(2⁸). The R-S code is T=1 (96, 94) over Galois Field GF(256), which is capable of performing 1 symbol error-correction every R-S block of 96 symbols. The (94,96) code is equivalent to a (253, 255) R-S code with 159 leading zero symbols followed by 96 non-zero symbols.

The GF(256) is constructed based on the following primitive polynomial over GF(2), namely,

$$p(X) = X^8 + X^4 + X^3 + X^2 + 1$$

The generating polynomial for the R-S code is defined as:

$$g(X) = (X-\alpha)(X-\alpha^2)$$

where α is a primitive element in GF(256). The OOB FEC frame consists of two Reed-Solomon blocks. This OOB FEC frame equals one MPEG transport packet as illustrated in Figure 3.

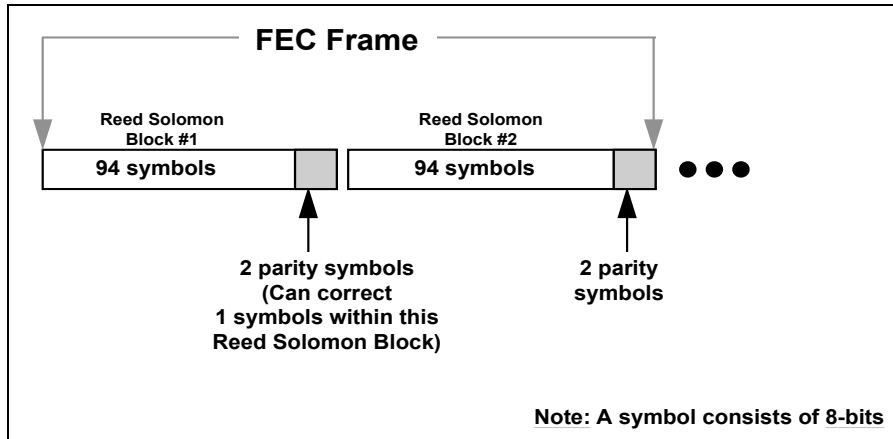

Figure 3: The OOB FEC Frame Packet Format

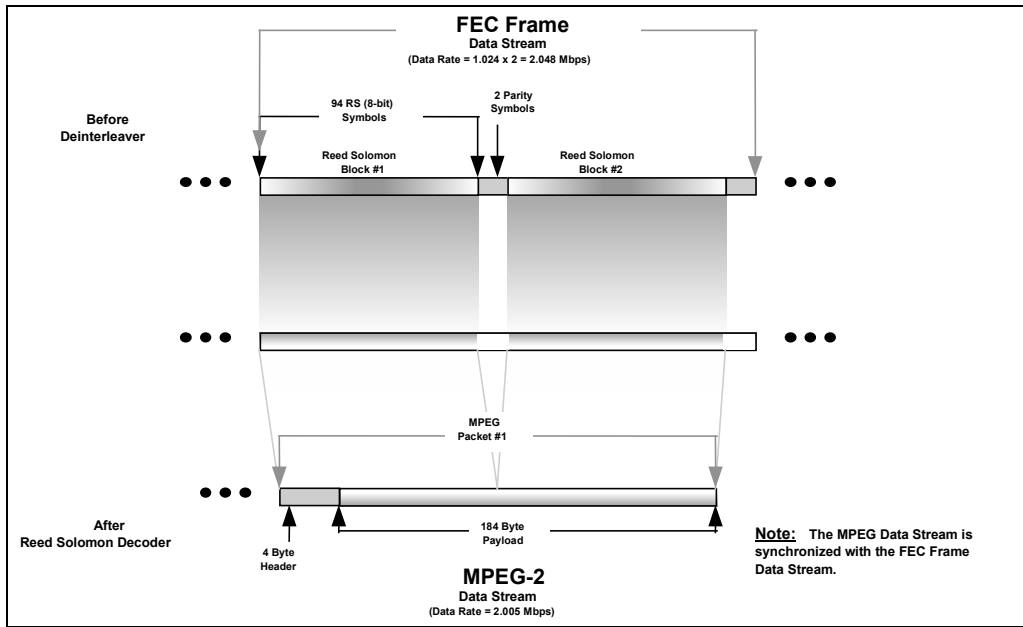

Figure 4: The Out-Of-Band FEC Frame to MPEG-TS Framing

Mapping from an FEC Frame to an MPEG-TS packet is illustrated in Figure 4. The first 94 bytes are unaltered and used directly as received. The next 2 bytes are the parity bytes obtained from the Reed-Solomon polynomial calculation. Two blocks of 96 bytes are sent for every 188 byte MPEG packet received. The FEC frame is reset at the start of each MPEG-TS packet.

6.1.2.3. OOB INTERLEAVER

Interleaving the coded R-S symbols before transmission and de-interleaving after the reception may cause multiple burst errors during transmission to be spread out in time. Thus, the receiver has to handle them as if they were random errors. Separating the R-S symbols in time enables the random-error-correcting R-S code to be useful in a bursty-noisy environment. Using a convolutional interleaver with a depth of $I = 8$ symbols, the R-S T=1 (96,94) decoder can correct an error burst of 8 symbols, which corresponds to a burst noise protection of 32 μsec .

Interleaving is synchronized to the R-S blocks and hence to MPEG-TS packets. MPEG-TS Sync bytes always pass through commutator branch 1 of the interleaver and hence are not delayed through the interleaver. The convolutional interleave algorithm delays various blocks of bytes in a systematic way, as illustrated in Figure 5.

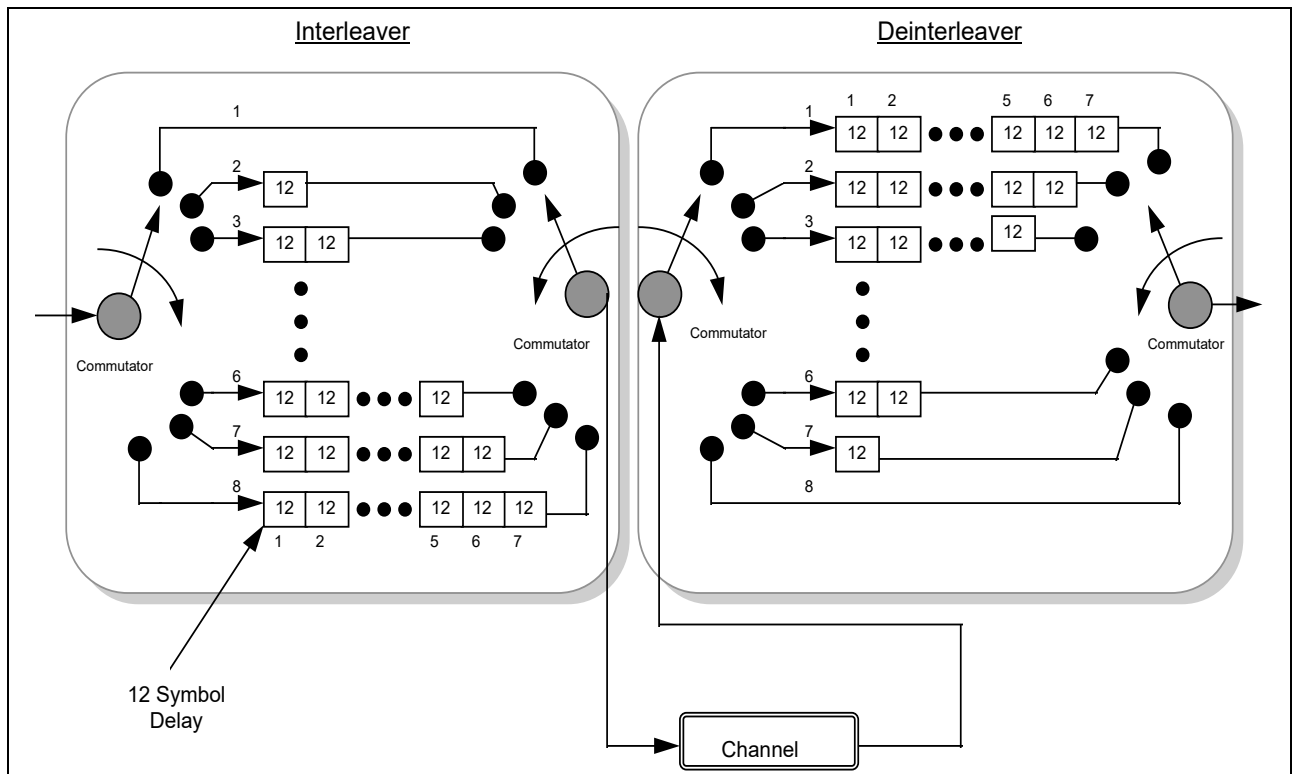

Figure 5: Out-of-Band Interleaving Functional Block Diagram

6.1.3. OOB QPSK MAPPING

The OOB modulator uses differential encoding scheme to resolve the 90° ambiguity in the detection of the QPSK signal at the demodulator. The OOB QPSK demodulator should be capable of handling both forms of differential coding as listed in Table 2. Also, a means of selecting the appropriate form of decoding for the user's system must be present in the QPSK demodulator.

I Data	Q Data	Default Carrier Phase Changes	Alternate Carrier Phase Changes
0	0	No Change	No Change
0	1	-90 degrees CW	+90 degrees CW
1	0	+90 degrees CW	-90 degrees CW
1	1	180 degrees	180 degrees

Table 2: The Differential Coding Scheme for OOB QPSK Signal

6.1.4. OOB MODULATOR RF OUTPUT

The OOB QPSK modulator RF output specifications are shown in Table 3.

Parameter Name	Specification
Center Frequency RF Output	75.25 ¹ MHz carrier frequency
Step Size for RF Output	50 kHz
RF Output Power range	+30 to +50 dBmV
Output level stability vs. time & temperature	±2 dB
Output level stability vs. frequency changes	±2 dB
RF Center frequency accuracy	±0.01%
I/Q Amplitude Imbalance	0.5 dB typical
I/Q Phase Imbalance	1.0 degree typical

1. Other OOB carrier frequencies in the 70 to 130 MHz are possible.

Table 3. The OOB Modulator RF Output

6.1.5. OOB CARRIER INPUT POWER AT RECEIVER

The received power level of the OOB carrier at the subscriber's decoder is from +5 dBmV to -10 dBmV at 75 Ω cable impedance.

6.2. PHYSICAL LAYER FOR RETURN-PATH TRANSMISSION

6.2.1. RETURN-PATH MODEM DESCRIPTION

For most applications, the return-path data sent from the subscriber site to the cable-TV headend is generated and must be transmitted in short bursts. The small ATM protocol cell structure is well suited to this need. A block code FEC is used to allow both correction of some transmission errors and detection of packets that cannot be corrected. For many applications upstream packets that cannot be corrected can be re-transmitted. Block or convolutional interleaving is not appropriate since their function is to spread-out error bursts over many FEC blocks. These upstream transmissions are often a single FEC block.

6.2.2. RF RETURN PATH PACKET FORMAT

The upstream data sent from subscriber Digital Terminals to the headend is in ATM packet format. Each ATM packet is concatenated with a 28 bit Unique Word, a one byte Packet Sequence counter, and 8 Reed Solomon parity bytes as shown in Table 4. The 28 bit Unique Word, which can be written as (I,Q), is used to identify the start of the data packet for robust Sync detection by the return-path receiver. The packet sequence byte consists of a message number (3 bits), and a sequence number (5 bits). The message number is used to associate upstream cells with a particular Protocol Data Unit (PDU). It is incremented every time the first cell of a new PDU is sent. The sequence number, which has a field length of 5 bits, is used to identify the order of the cells within a PDU. It starts at 0 for each new message number, and used by the headend return-path demodulator to detect missing cells for the RF modem report-backs.

Parameter	Specification
Unique Word	28 bits (1100 1100 1100 1100 1100 1100 0000)
Packet Sequence	1 byte
ATM data	53 bytes
R-S parity	8 bytes

Table 4: Upstream Packet Format

6.2.3. RF RETURN-PATH FORWARD ERROR CORRECTION

The FEC code in the return-path transmission link is a R-S T=4 (62,54) code over the GF(256) field. Each R-S symbol consists of 8 bits. This FEC code is capable of correcting four symbol errors for a R-S block of 62 symbols. The following primitive polynomial over GF(256) is used:

$$p(X) = X^8 + X^7 + X^2 + X + 1$$

The generator polynomial for this FEC code is:

$$g(x) = (X-\alpha^{120})(X-\alpha^{121})(X-\alpha^{122})(X-\alpha^{123})(X-\alpha^{124})(X-\alpha^{125})(X-\alpha^{126})(X-\alpha^{127})$$

where α is a primitive element in GF(256).

The encoding circuit is efficiently implemented via shift registers using arithmetic over GF(256).

6.2.4. RF RETURN-PATH RANDOMIZER

The randomizer circuit uses a PN generator, which employs a 13 bit shift register. The input bit stream is XOR'ed with this PN sequence. Taps are located at the output of stages 1, 3, 4, and 13 of the shift register. Stages 1 to 5 of the shift register are always initialized to zero for each packet. Stages 6-13 are initialized to

a programmable value. The 8 bit default value for this initialization is all ones (0xFF). The randomizer is shown in Table 5. The generating polynomial is identical to the one used in the OOB randomization circuit.

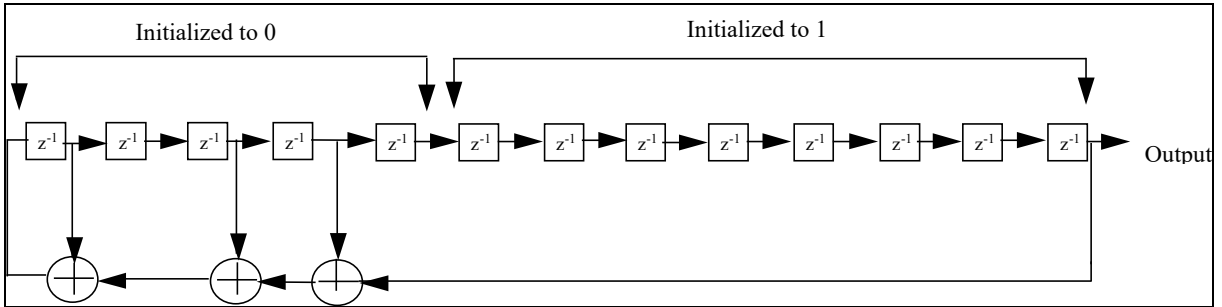

Table 5: RF Return Path Randomizer

6.2.5. RF RETURN PATH MODULATOR

The return path modulator uses differential encoding to enable phase invariant reception at the headend. Two modes of differential decoding are defined to accommodate different system local oscillators. The default mode is used unless the alternate is explicitly selected. The two differential coding schemes are defined in Table 6 as follows:

I Data	Q Data	Output	
		Default Mode	Alternate Mode
0	0	No Change	No Change
0	1	+ 90 degrees CW	- 90 degrees CW
1	0	- 90 degrees CW	+ 90 degrees CW
1	1	180 degrees	180 degrees

Table 6: Phase Change of QPSK Carrier

The output data from the differential encoder feeds the Nyquist pulse shaping filters which are implemented using Square Root Raised Cosine filters with a 50% roll-off ($\alpha = 0.5$). The output of the filters feeds the QPSK modulator which assigns two input bits per symbol. The data transmission rate of the signal is 256 kbps. The return-path modulator operates over the entire specified frequency range from 8 to 40 MHz.

The return path modulator output specifications are summarized in Table 7.

Parameter Name	Specification
Modulation Type	Differentially-Encoded QPSK
Access Scheme	Polling and ALOHA (programmable)
Data Transmission Rate	256 kbps \pm 50 ppm

Symbol Rate	128 kbps \pm 50 ppm
Channel Spacing	192 kHz
Transmit Filter Shape	Square-Root Raised Cosine, $\alpha = 0.5$
FEC Code	R-S T = 4 (62,54) over GF(256)
RF Output Power Range	+24 dBmV to +60 dBmV
Spurious Output Level (idle state)	< -30 dBmV (in-band), < -65 dBmV (out-of-band)
Spurious Output Level (active state)	< -50 dBc (in-band), < -65 dBmV (out-of-band)
Frequency Range	8.096 MHz to 40.160 MHz in 192 kHz steps
System Clock Frequency	4.096 MHz

Table 7: RF Return-Path Modulator Output Specifications

6.2.6. RF RETURN-PATH DEMODULATOR SPECIFICATION

The return-path differentially-encoded QPSK demodulator uses the same FEC code as the modulator. The required $C/(N+I)$ of the input signal, which includes interference effect (I) due to ingress and impulse noise in the return-path channels, is equal or greater than 20 dB at packet error rate (PER) less than $1 \cdot 10^{-7}$ (corresponds to one packet loss every 5 hours). The required $C/(N+I)$ assumes the simultaneous presence of multiple impairments in the upstream channel. PER is the ratio of the number of error packets to the total number of transmitted packets. The return-path demodulator specifications are summarized in Table 8.

Parameter Name	Specification
RF Input Level	3 ± 10 dBmV
$C/(N+I)$ of Input Signal	≥ 20 dB @ PER ¹ < $1 \cdot 10^{-7}$ (post FEC)
Block Synchronization	Unique Word
Channel Tuning Resolution	8 kHz
Signal Level Measurement Accuracy	± 2 dB at the input
Spurious and Harmonics Level	< -40 dBc @ 128 kHz (In-band)

¹ PER = Packet Error Rate

Table 8: RF Return-Path Demodulator Specifications

6.3.EXTENDED PRACTICE FOR RETURN-PATH TRANSMISSION

This section provides the specifications of the extended practice for return-path transmission systems. The higher upstream transmission rates are optional for new decoder boxes and cable modems applications.

The return-path modulator output specifications are summarized in Table 9. It references to DOCSIS RFI specifications: Radio Frequency Interface Specification SP-RFIV1.1-I01-990311 [3]. As DOCSIS is still evolving with extended practices for more enhanced data features, the current implementation may be upgraded as future needs arise.

The maximum channel bandwidth (measured at -30 dB) is 25% larger than the symbol rate (in kHz), except for the lowest symbol rate case, which has a bandwidth of 192 kHz.

Parameter Name	Specification
Modulation Type	Differentially-Encoded QPSK and 16-QAM
Symbol Rate	128, 160, 320, 640, 1280, 2560 kSym/s \pm 50 ppm
RF output Power Range	8 to 58 dBmV (QPSK), 8 to 55 dBmV (16-QAM)
Transmit Output Power Accuracy	\pm 2 dB
Output Power Step Size Accuracy	\pm 0.4 dB
Transmit Filter Shape	Square-Root Raised Cosine, $\alpha = 0.25$
FEC Code	Programmable R-S T = 1 to T=10 over GF(256)
Integrated Phase Noise (in-band)	\leq -43 dBc (including discrete spurious noise)
Spurious Output Level	-53 dBc (during bursts), -72 dBc or -59 dBmV (between bursts)
Frequency Range	5 to 42 MHz

Table 9: RF Return-Path Modulator Output Specifications

The extended transmission specifications, which are based on DOCSIS/MCNS specifications [3] for the RF return-path demodulator, are summarized in Table 10.

Parameter Name	Specification
Nominal Received Power Range (for each carrier)	-16 to +14 dBmV (160 kSym/s) -13 to +17 dBmV (320 kSym/s) -10 to +20 dBmV (640 kSym/s) -7 to +23 dBmV (1280 kSym/s) -4 to +26 dBmV (2560 kSym/s)
RF Input Signal Level Range	± 6 dB of nominal received power
Maximum Received Power	< 35 dBmV
Block Synchronization	Variable-length preamble up to: 512 symbols (QPSK), 256 symbols (16-QAM)
Group-Delay Variation (in-band)	≤ 100 ns

1 SER = Symbol Error Rate

Table 10: Return-path Demodulator Specifications

7. DATA LINK LAYER

This section describes the Data Link Layer of the Out-Of-Band downstream and upstream channels. It specifies the communication between Network Related Control (NRC), for example the Network Controller at the headend, and the Digital Terminal. It is largely based on General Instrument's past contributions to DAVIC and MCNS. The Medium Access Control sublayer is comprised of control messages, described within this section, and is independent of the physical layer; hence it may reside above any different rate of the physical layer, as well as In-Band or Out-Of-Band, without any loss of functionality. Another MAC characteristic is that it can be tailored to accommodate different traffic characteristics dynamically or per configuration. The need for this adaptability would largely depend on how interactive services will be received by consumers and at what growth-rate. At present, only contention-mode access (Aloha, non-TDMA) is considered as a requirement. Therefore, any TDMA related consideration is strictly optional.

The Data Link Layer, along with its MAC (Media Access Control) sublayer, are responsible for transporting Network Layer PDUs between the Digital Terminal and the headend. The layer also provides segmenting and re-assembly of higher layer PDUs, e.g. network layer, as well as routing to the corresponding protocol stack. Additional information about general DLL and MAC functionality may be found in IEEE Std 802-1990, Local and Metropolitan Area Networks: Overview and Architecture and ISO/IEC 10039:1991 Information Technology, Open Systems Interconnection, Local Area Networks, Medium Access Control (MAC) Service Definition [1].

To maximize the synergy on the In-Band and Out-Of-Band, the link layer syntax is MPEG-2 TS based. This is described further in the following sections. Additional detail may be found in ITU-T Recommendation H.222.0 | ISO/IEC 13818-1:2007, Information Technology -- Generic Coding of Moving Pictures and Associated Audio Information Systems [2].

7.1. APPLICATION PDU PROCESSING

Figures 6 and 7 show the packetization schemes for upstream and downstream, respectively.

For the upstream direction, the higher protocol layers hand off the SDU to the data link layer. The data link layer adds the Upstream Link Layer Header and Upstream Link Layer Trailer. Padding may also be necessary so that the entire Data Link Layer PDU (i.e. Upstream Link Layer Header + Higher Layer PDU + Padding + Upstream Link Layer Trailer) is a multiple of 48 bytes. The pad character is 0x00. The CRC in the Link Layer Trailer is computed over the entire Data Link PDU.

In the downstream direction, MPEG-2 transport packets are received and filtered based on PID values. Following this, Data Link Layer messages are re-assembled, address filtered, and CRC checked. From an MPEG-2 point of view, Data Link Layer messages form an MPEG-2 private stream. The re-assembly of those messages from the underlying MPEG-2 transport packets is as per the MPEG-2 specification, using the Payload Unit Start Indicator bit in the MPEG-2 transport packet header. Those messages addressed to the Digital Terminal are processed by the Digital Terminal. For packets containing higher layer application PDUs, the PDU is extracted, reassembled and routed based on the Protocol ID field.

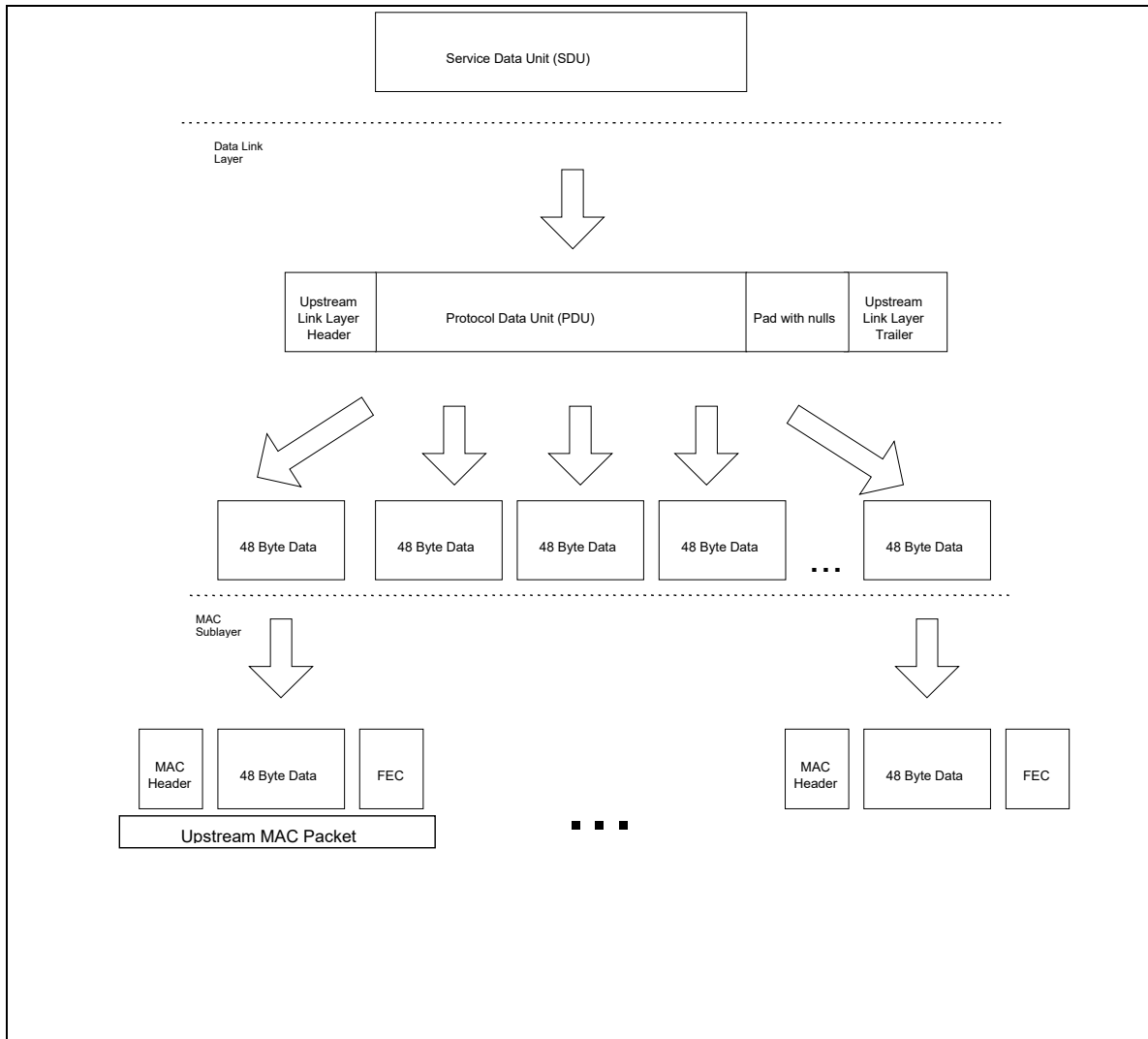

Figure 6: Upstream Data Link Layer Processing of Application PDUs

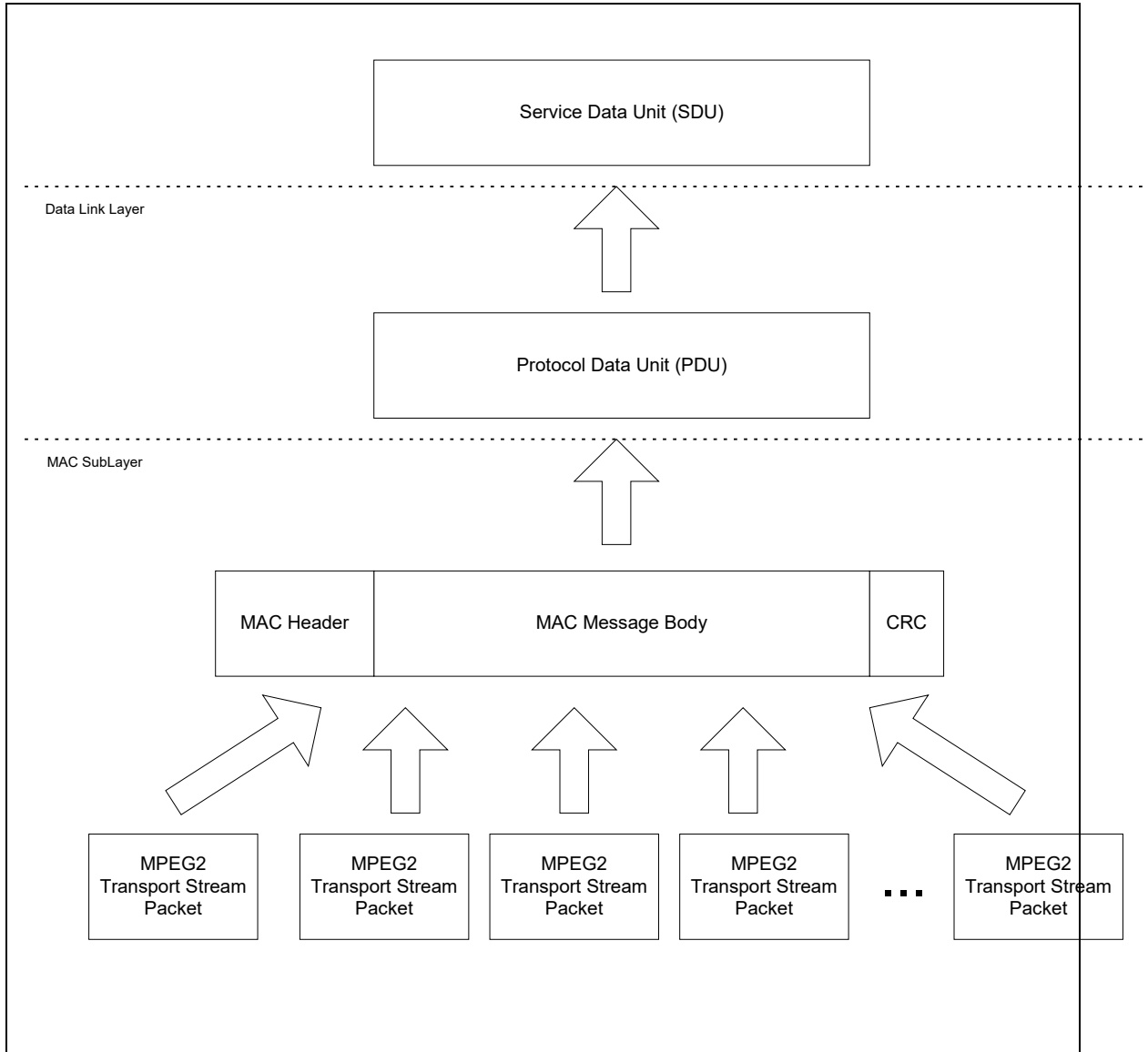

Figure 7: Downstream Data Link Layer Processing of Application PDUs

7.2. LINK LAYER HEADERS/TRAILERS

Link Layer Headers/Trailers encapsulate the downstream and upstream PDUs. In both directions, the Link Layer Headers include a protocol identifier which allows multiple protocol stacks to reside above the Data Link Layer. Also, the Link Layer Headers provide information such as the length of the higher layer PDU.

7.2.1. UPSTREAM LINK LAYER HEADER

The Upstream Link Layer Header includes a protocol ID which allows multiple protocol stacks to reside over the Data Link Layer. The upstream link layer trailer includes information which is needed to re-assemble received MAC packets into Link Layer packets in the headend. The upstream link layer header and trailer are defined as follows:

Upstream_LL_Header(){	Bits	Bytes	Bit Number / Description
Protocol_Id	8	1	
}			

Upstream_LL_Trailer(){	Bits	Bytes	Bit Number / Description
Reserved	16	2	
Msg_Length	16	2	in bytes
CRC	32	4	
}			

Protocol_Id

Protocol_Id identifies the protocol stack above the Data Link Layer. The current protocols defined are:

Protocol ID	Protocol
0x00	IP
0x01	Simple Connectionless Protocol (SCP)
0x02	Administration Protocol

Table 11: Protocol Ids

Protocol_ID “1” is for compressed form of UDP/IP. Protocol_ID “2” is for administrative functions above the MAC layer.

Msg_Length

This is the length of the original higher layer PDU in bytes, plus the Upstream Link Layer Header. It does not include padding or the Upstream Link Layer Trailer.

CRC

32 bit CRC function, computed over the entire Data Link Layer PDU, including the padding field.

7.2.2. PADDING

The entire Data Link Layer PDU, including the Upstream Link Layer Header, the Higher Layer PDU, and the Upstream Link Layer Trailer, must be a multiple of 48 bytes. In order to achieve this, it may be necessary to add padding between the higher layer PDU and the Upstream Link Layer Trailer. The padding character is 0x00.

7.2.3. DOWNSTREAM LINK LAYER HEADER

The Downstream Link Layer Header consists of a Protocol Identifier. This Protocol Id allows multiple protocol stacks to reside over the Data Link Layer.

The following header is prefixed to higher layer PDUs in the downstream direction. Its purpose is to aid in the re-assembly of PDUs.

Downstream_LL_Header(){	Bits	Bytes	Bit Number / Description
Protocol_Id	8	1	
}			

Protocol_Id

Same as in the Upstream Link Layer Header in Section 6.2.1.

7.2.4. UPSTREAM CRC FUNCTION

In the upstream direction, the CRC is part of the link layer. The polynomial for the CRC used in the upstream direction is the CRC-32-CCITT (or CRC-32-IEEE802.3) polynomial as shown below:

$$x^{32} + x^{26} + x^{23} + x^{22} + x^{16} + x^{12} + x^{11} + x^{10} + x^8 + x^7 + x^5 + x^4 + x^2 + x + 1.$$

The initial seed for the calculation is 0xffffffff.

7.2.5. DOWNSTREAM CRC FUNCTION

The downstream trailer consists of the CRC. In the downstream direction, the CRC is part of the MAC sublayer. The polynomial for the downstream CRC calculation is as follows:

$$x^{32}+x^{26}+x^{23}+x^{22}+x^{16}+x^{12}+x^{11}+x^{10}+x^8+x^7+x^5+x^4+x^2+x+1.$$

The initial seed for the calculation is 0xffffffff.

7.2.6. ACKNOWLEDGMENT PROTOCOL

A simple acknowledgment protocol is used which allows for an acknowledgment message transmitted by the headend in response to each upstream MAC cell received. After transmitting each MAC cell upstream, the terminal will await either an acknowledgment message or the expiration of a timer. If no acknowledgment is received and the timer expires, the Digital Terminal uses a randomized backoff algorithm to wait and retransmit the cell. The randomization is required to prevent two colliding stations from becoming synchronized and continuously colliding as they backoff and retry. This contention resolution scheme is an exponential random backoff algorithm similar to the one used by Ethernet.

The upstream MAC cell contains a retry counter. The retry counter is set to 0 for the initial transmission of an upstream cell. Every time the cell is retransmitted, the retry counter is increased. The retry counter is used by headend equipment to determine what the collision level is on a particular upstream channel. A key parameter for the Acknowledgment Protocol is the MAX_ACKNOWLEDGMENT_TIME parameter.

The retry counter and the MAX_ACKNOWLEDGMENT_TIME are programmable.

7.3. SEGMENTATION AND RE-ASSEMBLY

7.3.1. UPSTREAM

To efficiently accommodate multi-rate TDMA for guaranteed response time performance, a fixed length packet size is required. One of the factors governing the packet size is the granularity required to carry typical higher layer data units as well as efficiently facilitate multi-rate configuration. In addition to packetization, segmentation and re-assembly are required to support higher layer data units of sizes larger than the packet payload size. All factors considered, an ATM (fixed cell size) approach becomes a suitable choice. The upstream segmentation and re-assembly algorithm is based on ATM Adaptation Layer 5 (AAL5). The Upstream Link Layer Trailer corresponds to the AAL5 Trailer and contains the `Msg_Length` field which indicates the length of the original higher layer PDU. As with AAL5, the lower layer MAC packets contain a field (Payload Type) to indicate which MAC packet is the *last* MAC packet in a PDU. By knowing which MAC packet is the last MAC packet, and given that the entire Data Link Layer PDU was padded out to a 48 byte multiple, it is possible to extract the `Msg_Length` field from the last MAC packet. Using this field, it is then possible to compute the number of MAC packets which make up the PDU.

7.3.2. DOWNSTREAM

In the downstream direction, packets are segmented into an MPEG-2 transport stream. Re-assembly utilizes information in the transport packet header and is defined in the MPEG-2 specification.

7.3.3. MAXIMUM PDU SIZES

In the upstream direction, the Link Layer can accept PDUs up to a maximum of 1024 bytes. Including the header and trailer overhead, this would translate into a maximum of 22 MAC packets.

In the downstream direction, the Link Layer can accept PDUs up to a maximum of 1010 ($= 1024 - 14$) bytes for singlecast PDUs, or 1015 ($= 1024 - 9$) bytes for broadcast PDUs. This is derived by subtracting the Link Layer Header and CRC from 1024 bytes, the limitation of MPEG-2 messages.

7.4. MAC INFORMATION TRANSPORT

The scope of this section is limited to the definition and specification of the MAC Layer protocol. The detailed operations within the MAC layer are hidden from the above layers.

This section focuses on the required message flows between the headend and the Digital Terminal for Media Access Control. These messages are divided into three categories: Initialization, Provisioning and Sign-On Management, Connection Management and Link Management.

7.4.1. DOWNSTREAM MAC MESSAGE FORMAT

Note: All messages are sent most significant bit first.

Downstream_MAC (){	Bits	Bytes	Bit Number / Description
Message_Type	8	1	
Always_zero	1	2	15: 0
Address_Type	3		14..12
Message_Length	12		11..0
If (Address_Type== singlecast_unit){ unit_creation_address }	40	5	
If (Address_Type== singlecast_network){ network_address }	40	5	
If (Address_Type== multicast40_address){ multicast40_address }	40	5	
If (Address_Type== multicast16_address){ multicast16_address }	16	2	
If (Address_Type== multicast24_address){ multicast24_address }	24	3	
Message_Type_Version_Field	8	1	
frames_extention_flag	1		7: set to 0
segmentation_overlay_included	1		6: set to 0
message_preamble	1		5: set to 0
message_type_version	5		4..0: set to 0
}			

Message_Type

This field indicates the type of message being transmitted. For the MAC Layer, two message types are defined - one for interactive application data (i.e. user data that have been adapted (segmented) into MAC packets), the other for MAC Signaling Messages.

Value	Message Type
0x8E	Interactive Data
0x8F	MAC Signaling

Table 12: MAC Message Type Values

Address_Type

Address_Type defines the type of address included in the message. The following table outlines defined address types:

Value	Address type
0x00	broadcast
0x01	singlecast_unit
0x02	singlecast_network
0x03	multicast40
0x04	multicast16
0x05	multicast24

Table 13: Address Types

Message_Length

Message_Length, expressed in bytes, includes all fields following the Message_Length field itself (including the CRC).

Message_Type_Version_Field

This field contains three flags (all set to 0) and the Message_Type_Version_Field, which must be set to 0 as well.

The address types are for the downstream direction to the Set Top Box as the message name specifies. As the address fields are of different lengths, the downstream header size will vary with different address types.

7.4.2. UPSTREAM PACKET FORMAT

The upstream packet format is as follows:

Reserved (1 bits)	Messag Number (2 bits)	Seq. Num (5 bits)	MAC CTRL (4 bits)	UPM Address (24 bits)	PT (3 bits)	Ack Req (1 bit)	Retry Counter (8 bits)	PAYLOAD (48 bytes)
----------------------	------------------------------	-------------------------	-------------------------	-----------------------------	----------------	-----------------------	------------------------------	-----------------------

Each upstream packet is prefixed by a unique word (28 bits) which allows the burst demodulator to identify the start of the packet. Upstream packets also include an 8 byte FEC field for error detection and correction.

Upstream_Packet(){	Bits	Bytes	Bit Number / Description
Reserved	1	1	7
Message_Number	2		{6..5} / Increments for each new PDU
Sequence_Number	5		{4..0} / Increments for each new MAC packet transmitted upstream. Starts at 0 for each new Segmented PDU Number.
MAC_Control_Field	4	4	{31..28} / Used to identify the nature of the MAC packet.
UPM_Address	24		{27..4} / Upstream MAC Address. Identifies decoder-transmitting packet.
Payload_Type	3		{3..1} / 1 for last MAC packet in a PDU. 0: Otherwise.
ACK_Required	1		{0} / 1 for MAC packets requiring Acknowledgment. 0: Otherwise.
Retry_Counter	8	1	Increments for each retransmission of a MAC packet.
Payload	384	48	Payload
}			

Message_Number

The Message_Number, or the Segmented PDU Number field is used to associate packets with a particular PDU. It increments every time the first packet of a new PDU is sent.

Sequence_Number

The Sequence_Number is used to identify the order of packets within a PDU. It starts at 0 for each new Message_Number (see above). The Sequence_Number does not increment when a packet is re-transmitted because an acknowledgment was not received.

MAC_Control_Field

The MAC_Control_Field identifies the nature of the MAC Packet. The following table shows values for the MAC Control Field:

MAC Control Field	Description
0000	Application Data
0001	Application Data, no segmentation
1001	MAC Signaling Messages
1000	Reserved
1100	Reserved

Table 14: MAC Control Field Values

UPM_Address

The Upstream MAC, UPM_Address is used in the NRC to associate a received packet with a particular decoder.

Payload_Type (PT)

This field is used by the re-assembly engine. In AAL5, the information needed to re-assemble a higher layer PDU from individual ATM packets (MAC packets in this system) is contained in the last packet. Therefore, the last packet must be indicated. This field is set to 0x01 if the packet is the last (or only) packet which makes up a PDU. The field is 0 otherwise.

Ack_Required

A value of 1 indicates that the packet requires an explicit acknowledgment from the NRC. A value of 0 indicates that no acknowledgment is required or expected.

Retry_Counter

This field indicates the number of times the decoder had to retry when sending a packet upstream before it was correctly received. The NRC equipment can examine this field for statistics and diagnostic information. The first time a packet is transmitted upstream, this field is set to 0. It increments every time the same packet is re-transmitted because an acknowledgment was not received.

Payload

This is the data portion of the packet and contains 48 bytes of data. Since higher level PDUs are already padded up to 48 bytes, no additional padding is needed. For MAC Signaling Messages, which may be shorter than 48 bytes, the remainder of the payload is padded with the null (0x00) character.

7.5. MAC SIGNALING MESSAGES

7.5.1. MAC SIGNALING MESSAGE ENCAPSULATION

MAC signaling messages are part of the MAC sub-layer. As such, they are transported in MAC packets. In the upstream direction, MAC signaling messages are placed directly into a MAC packet, and do not contain the Link Layer Header, nor do they contain the CRC field. The Payload Type field in the upstream MAC header is, by definition, 1, for all MAC signaling messages. Note that since MAC Signaling Messages may be less than 48 bytes, the remainder of the 48 byte payload in the MAC packet should be padded up with the null (0x00) character.

In the downstream direction, MAC signaling messages do not contain the downstream link layer header. They are prefaced by the MAC header and appended with the CRC. MAC Signaling messages are designated by the value of the Message Type field.

Figures 8 and 9 indicate the encapsulation for MAC Signaling Messages.

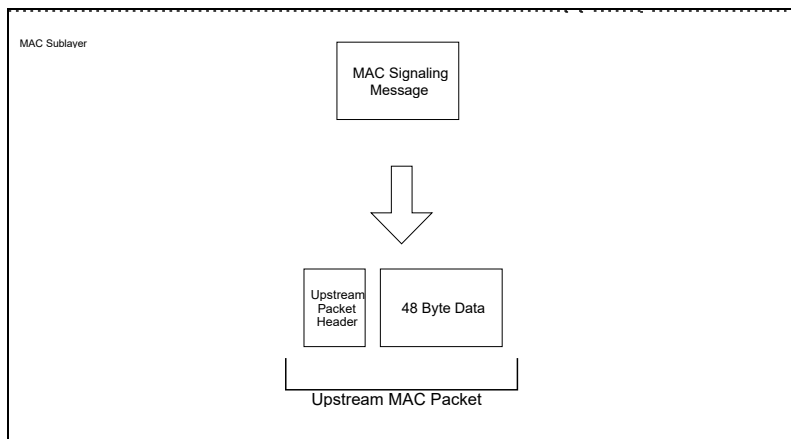

Note: MAC Control field in MAC Header indicates MAC signaling

Figure 8: Encapsulation of MAC Signaling Messages Upstream

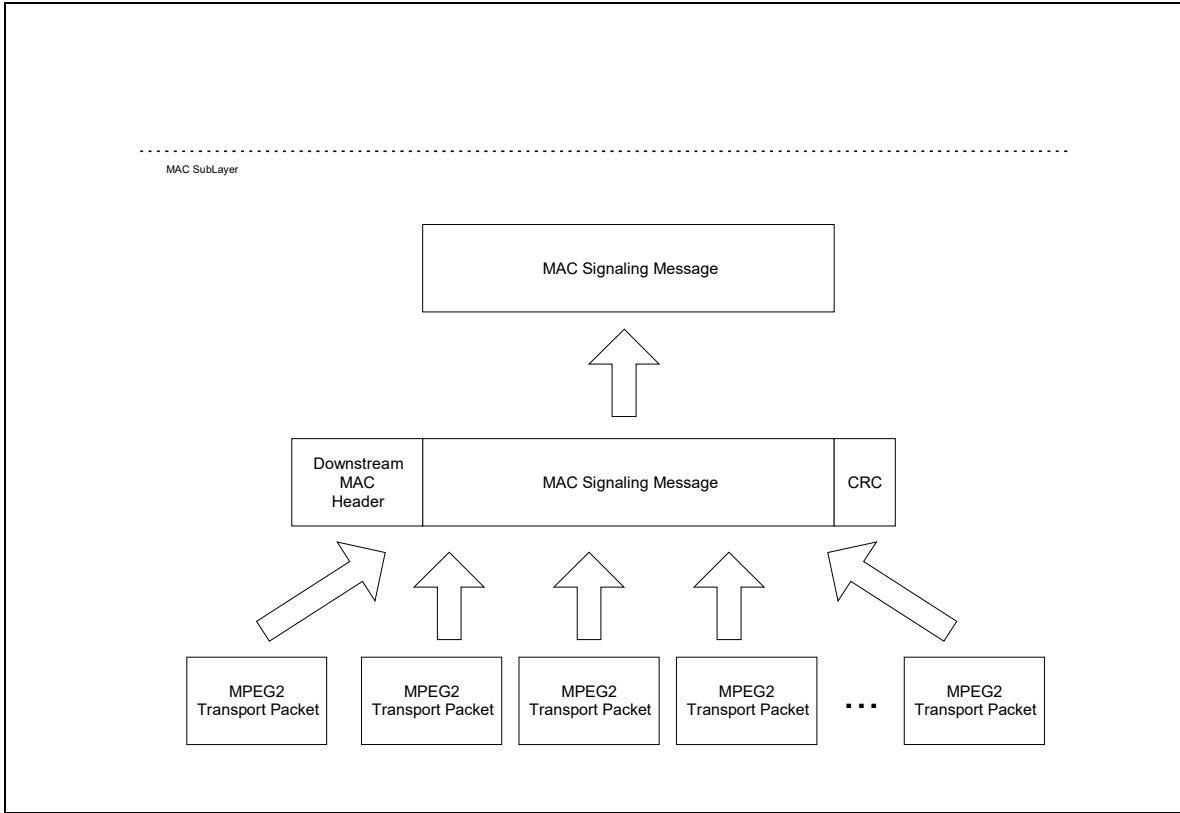

Figure 9: Encapsulation of MAC Signaling Messages Downstream

7.5.2. MAC SIGNALING MESSAGE FORMAT

The MAC Signaling Message below is defined in the DAVIC specification[4]. All MAC signaling messages, whether upstream or downstream, conform to this message format.

(Note: All messages are sent most significant bit first.)

MAC_Signaling_Message(){	Bits	Bytes	Bit Number / Description
Message_Configuration		1	
Protocol_Version	5		7..3:{enum}
Syntax_Indicator	3		2..0:{enum}
Message_Type	8	1	
if (Syntax_Indicator==001) {			
MAC_Address	48	6	
}			
MAC_Information_Elements ()		N	
}			

Protocol_Version

Protocol_Version is a 5 bit enumerated type used to identify the current MAC version.

For this version of the MAC, the Protocol Version will be 0x1f.

Syntax_Indicator

Syntax_Indicator is a 3-bit enumerated type that indicates the addressing type contained in the MAC message.

```
enum Syntax_Indicator      {      No_MAC_Address,
                             MAC_Address_Included,
                             Reserved 2..7      };
```

MAC_Address

MAC_Address is a 48-bit value representing the unique MAC address of the Digital Terminal. Specifically, the MAC address is the 40 bit unit address of the terminal, with the most significant 8 bits set to 0.

7.5.3. ALOHA MAC MESSAGES

The table below shows the MAC message types defined by DAVIC[4].

Messages shown in *italics* are transmitted from the Digital Terminal to the headend.

Messages which are used in the ALOHA MAC are underlined in the table below.

Message Type Value	Message Name	Addressing Type
0x01-0x1F	MAC Initialization, Provisioning and Sign-On Message	
0x01	Provisioning Channel Message	Broadcast
0x02	<u>Default Configuration Message</u>	Broadcast
0x03	<u>Sign-On Request Message</u>	Broadcast
0x04	<u>Sign-On Response Message</u>	Singlecast
0x05	Ranging and Power Calibration Message	Singlecast
0x06	<i>Ranging and Power Calibration Response Message</i>	Singlecast
0x07	Initialization Complete Message	Singlecast
0x08-0x1F	[Reserved]	Singlecast
0x20-0x3F	MAC Connection Establishment and Termination Msgs	
0x20	Connect Message	Singlecast
0x21	<i>Connect Response Message</i>	Singlecast
0x22	<i>Reservation Request Message</i>	Singlecast
0x23	Reservation Response Message	Broadcast
0x24	Connect Confirm Message	Singlecast
0x25	Release Message	Singlecast
0x26	<i>Release Response Message</i>	Singlecast
0x27	<u>Idle Message</u>	Singlecast
0x28	Reservation Grant Message	Singlecast
0x29	Reservation ID Assignment	Singlecast
0x2A	<i>Reservation Status Request</i>	Singlecast
0x2B	<i>Reservation ID Response Message</i>	Singlecast
0x2C-0x3F	Reserved]	
0x40-0x5F	MAC Link Management Msgs	
0x40	<u>Transmission Control Message</u>	Singlecast/ Broadcast
0x41	Reprovision Message	Singlecast
0x42	<u>Link Management Response Message</u>	Singlecast
0x43	<u>Status Request Message</u>	Singlecast
0x44	<u>Status Response Message</u>	Singlecast
0x45-0x5F	[Reserved]	
0x60-0x6F	Private MAC Extensions	
0x60	<u>Logical Address Message</u>	Singlecast
0x61	<u>Contention Channel List Message</u>	Broadcast
0x62	<u>Acknowledge/Power Adjust Message</u>	Singlecast
0x63	Synchronization Timebase Message	Broadcast

7.5.3.1. <MAC> DEFAULT CONFIGURATION MESSAGE

The <MAC> DEFAULT CONFIGURATION MESSAGE is sent by the headend to the Digital Terminal. The message provides default parameter and configuration information to the Digital Terminal. The format of the message is shown below.

Default_Configuration_Message(){	Bits	Bytes	Bit Number / Description
Sign-On_Incr_Pwr_Retry_Count	8	1	
Service_Channel_Frequency	32	4	
Service_Channel_Control_Field		1	
MAC_Flag_Set	5		7..3
Service_Channel	3		2..0
Backup_Service_Channel_Frequency	32	4	
Backup_Service_Channel_Control_Field		1	
Backup_MAC_Flag_Set	5		7..3
Backup_Service_Channel	3		2..0
Service_Channel_Frame_Length	16	2	
Service_Channel_Last_Slot	13	2	15..3
Upstream_Transmission_Rate	3		2..0
Max_Power_Level	8	1	
Min_Power_Level	8	1	
Power_Increment	8	1	
Timebase_Terminal_Count	32	4	
Ticks_Per_Timeslot	16	2	
OBTM_Correction_Factor	32	4	
IBTM_Correction_Factor	32	4	
Idle_Interval_Timer	16	2	in seconds
Default_Response_Collection_Time_Window	16	2	in seconds
Init_Abort_Timer	16	2	in seconds
}			

Sign-On_Increment_Power_Retry_Count

Sign-On_Incr_Pwr_Retry_Count is an 8-bit unsigned integer representing the number of attempts the Digital Terminal should try to enter the system at the same power level before incrementing its power level. The power level is incremented by 0.5 decibels each time.

Service_Channel_Frequency

This is the upstream frequency that the Digital Terminal should use to enter the network. All Sign-On messages should be sent on this frequency initially.

Backup_Service_Channel_Frequency

During network entry, if the terminal reaches maximum power on the service channel and still has not been able to enter the network, it will switch to the backup service channel and will try to enter the network. If this also fails, it will switch back to the service channel and try again, alternating between the two until it can enter the network. Not all systems will have a backup service channel. If none is available, this field should be set to 0.

**Service_Channel_Control_Field, Backup_Service_Channel_Control_Field,
Service_Channel_Frame_Length, Service_Channel_Last_Slot, Upstream_Transmission_Rate**

These parameters are not applicable to the ALOHA MAC.

Maximum_Power_Level

MAX_Power_Level is an 8-bit unsigned integer representing the maximum power the Digital Terminal shall be allowed to use to transmit upstream. Maximum_Power_Level is defined in units of 0.5 dBuV. A maximum power level of 60 dBmV is required.

Minimum_Power_Level

MIN_Power_Level is an 8-bit unsigned integer representing the minimum power the Digital Terminal shall be allowed to use to transmit upstream. Minimum_Power_Level is defined in units of 0.5 dBuV. A minimum power level of 24 dBmV is required.

Power_Increment

This is the amount by which the terminal should increment its power level when attempting to enter the network. It is expressed in increments of 0.5 decibels.

**Timebase_Terminal_Count, Ticks_Per_Timeslot, OBTM_Correction_Factor,
IBTM_Correction_Factor:**

These parameters apply only to TDMA versions of the MAC and are therefore “don’t-cares” for the ALOHA MAC.

Idle_Interval_Timer

Idle_Interval_Timer is a 16 bit unsigned integer representing the amount of time (in seconds) the Digital Terminal shall wait between transmission of <MAC> IDLE MESSAGES. A value of 0 indicates that the terminal should not generate idle messages.

Default_Response_Collection_Time_Window

Used in the ALOHA MAC. The terminal will wait a random amount of time between 0 and Default_Response_Collection_Time_Window seconds after powering up before attempting to enter the network. This parameter may be set to 0 to indicate that the terminal should attempt to enter the network immediately upon powering up. *This parameter was not included in the original DAVIC[4] message.*

Init_Abort_Timer

This timer is used with the ALOHA MAC. When the terminal is waiting for the MAC Sign On Request or Logical Address message to continue initialization, it will set this timer. Should the timer expire before one of these messages is received, the terminal will assume the initialization process has failed and will restart the initialization process. A value of 0 is used to indicate that the terminal should use its internally coded default value for this timer. The unit of the Init_Abort_Timer is expressed in “seconds”.

7.5.3.2. <MAC> SIGN-ON REQUEST MESSAGE

For the ALOHA version of the MAC, the <MAC> SIGN-ON REQUEST MESSAGE is sent to a specific Digital Terminal to request that the Digital Terminal attempt to enter the network.

Sign-On_Request_Message(){	Bits	Bytes	Bit Number / Description
Sign-On_Control_Field		1	
Reserved	6		7..2
Upstream_Frequency_Included	1		1: {no,yes}
Address_Filter_Params_Included	1		0: {no,yes}
Response_Collection_Time_Window	16	2	in sec
If (Address_Filter_Params_Included==yes) {			
Address_Position_Mask	8	1	
Address_Comparison_Value	8	1	
}			
if (Upstream_Frequency_Included==yes){			
Upstream_Frequency	32	4	in Hz
}			
}			

Sign-On_Control_Field

Sign-On_Control_Field specifies what parameters are included in the SIGN-ON REQUEST

Upstream_Frequency_Included

This flag indicates whether the Digital Terminal should use an upstream frequency other than the Service Channel's frequency to enter the network. *Side Note: This feature was not provided for in the original DAVIC[4] specification.*

Address_Filter_Parameters_Included

These parameters will not be used in the ALOHA MAC.

Response_Collection_Time_Window

After receiving a Sign-On Request message, the terminal will wait a random amount of time between 0 and Response_Collection_Time_Window seconds before responding with the MAC Sign-On Response Message.

Upstream_Frequency

If included, this is the frequency on which the Digital Terminal should attempt to enter the network.

7.5.3.3. <MAC> SIGN-ON RESPONSE MESSAGE

The <MAC> SIGN-ON RESPONSE MESSAGE is sent by the Digital Terminal in order to enter the network. This message is sent on the Service Channel to the network. When a terminal first enters the

network using this message, it should set the Syntax Indicator in the MAC Signaling Message Header to 1 and include its 48 bit MAC address in the header.

Sign-On_Response_Message(){	Bits	Bytes	Bit Number / Description
Return_Path_Id	16	2	
Downstream_Path_Id	16	2	
Digital_Terminal_Status	32	4	{enum}
Digital_Terminal_Capabilities		2	
Reserved	15		1..15
True IP Capable	1		0: {no,yes}
Digital_Terminal_Error_Code	16	2	{enum}
Digital_Terminal_Retry_Count	8	1	
}			

Return_Path_Id, Downstream_Path_Id

These 16 bit Ids have been assigned to the terminal prior to the ALOHA MAC initialization and are sent upstream in the <MAC> SIGN ON RESPONSE MESSAGE.

Digital_Terminal_Status

See definition in <MAC> STATUS RESPONSE MESSAGE.

Digital_Terminal_Capabilities

This bit field parameter is used to indicate to the headend what the terminal’s capabilities are. Currently the only defined value indicates whether terminal supports true IP or not.

Digital_Terminal_Error_Code

Digital_Terminal_Error_Code is a 16-bit unsigned integer that indicates the error condition within the Digital Terminal

```
enum Digital_Terminal_Error_Code {No_Error=0,
    Range_Response_Timeout_Error,
    Default_Connection_Timeout,
    Connect_Confirm_Timeout,
    Upstream_Sign_On_Failed,
    Reserved 5..216-1    };
```

Digital_Terminal_Retry_Count

Digital_Terminal_Retry_Count is an 8-bit unsigned integer that indicates the number of transmissions of the <MAC> SIGN-ON RESPONSE MESSAGE.

7.5.3.4. <MAC> TRANSMISSION CONTROL MESSAGE

The <MAC> TRANSMISSION CONTROL MESSAGE is sent to the Digital Terminal from the headend to control upstream transmission on ALOHA channels.

Transmission_Control_Message(){	Bits	Bytes	Bit Number / Description
<p style="text-align: center;">Transmission_Control_Field</p> <p style="padding-left: 20px;">Reserved</p> <p style="padding-left: 20px;">Return_Path_Included</p> <p style="padding-left: 20px;">Stop_Upstream_Transmission</p> <p style="padding-left: 20px;">if (Return_Path_Included == yes) {</p> <p style="padding-left: 40px;">Return_Path_Id</p> <p style="padding-left: 20px;">}</p> <p>}</p>	6	1	7..2
	1		1: {no, yes}
	1		0: {no,yes}
	16	2	

Transmission_Control_Field

Transmission_Control_Field specifies the control being asserted on the channel.

If Return_Path_Included is set to 1, a Return_Path_Id will be present in the message, and the terminal should only process this message if its Return_Path_Id matches the one in the message.

Stop_Upstream_Transmission: A 1 in this bit indicates that the terminal should halt all upstream ALOHA transmission, including <MAC> Idles, after sending the response to this message. The terminal may resume upstream transmission upon receiving a <MAC> Transmission Control Message with a Stop Upstream Transmission bit set to 0, OR upon receiving a MAC Sign On Request message.

7.5.3.5. <MAC> LINK MANAGEMENT RESPONSE MESSAGE

The <MAC> LINK MANAGEMENT RESPONSE MESSAGE is sent by the Digital Terminal to the headend to indicate reception and processing of the previously sent Link Management Message. The format of the message is shown below..

Link_Management_Response_Message(){	Bits	Bytes	Bit Number / Description
<p style="text-align: center;">Link_Management_Message_Type</p> <p>}</p>	8	1	

Link_Management_Message_Type

The Link_Management_Message_Type is the message type to which this message is in response. For example, if this message is in response to a <MAC>TRANSMISSION CONTROL MESSAGE, the Link_Management_Message_Type field will be 0x40, whereas if this message is being sent in response to a <MAC>Logical Address Message, its value will be 0x60.

7.5.3.6. <MAC> IDLE MESSAGE

This message is sent upstream to the headend when the idle timer has expired and the terminal has not sent any cells upstream which required an Acknowledgment in the idle timer interval. The idle timer interval is configured in the <MAC> Default Configuration Message. This message is NOT sent upstream if the terminal has been told to stop upstream transmission with a <MAC> TRANSMISSION CONTROL MESSAGE.

Idle_Message(){	Bits	Bytes	Bit Number / Description
Idle_Sequence_Count	8	1	
Number_Open_Sockets	8	1	
Number_Error_Codes_Included	8	1	
for (i=0;			
i<Number_Error_Codes_Included;			
++i)			
Error_Param_Code	8	1	
Error_Param_Value	16	2	
}			
}			

Idle_Sequence_Count

Idle_Sequence_Count is an 8-bit unsigned integer representing the count of <MAC> IDLE MESSAGES transmitted while the Digital Terminal is Idle.

Number_Open_Sockets

Number_Open_Sockets is an 8-bit unsigned integer representing the number of sockets open on the Digital Terminal.

Number_Error_Codes_Included

The terminal may report error codes in the idle message. The number of codes reported in the message is indicated by this field.

Error_Param_Code, Error_Param_Value

Error_Param_Code is an 8 bit enumerated type field which indicates the type of error that occurred. For some types of errors, there may be a count associated with them. This count may be indicated in the Error_Param_Value field.

7.5.3.7. <MAC> STATUS REQUEST MESSAGE

The <MAC> STATUS REQUEST MESSAGE is sent by the headend to the Digital Terminal to retrieve information about the health, connection information and error states of the Digital Terminal. The headend can request either the address parameters, error information, connection parameters or physical layer

parameters from the Digital Terminal. The headend can only request one parameter type at a time to a particular Digital Terminal.

Note: Terminals which have had their upstream transmission suspended with a <MAC> Transmission Control message will still respond to <MAC> Status Request messages.

Status_Request_Message(){	Bits	Bytes	Bit Number / Description
Status_Control_Field		1	
Reserved	4		7..4
Status_Type	3		3..1: {enum}
Frequency_Included	1		0: {no,yes}
if (Frequency_Included==yes)			
Response_Frequency	32	4	in Hz
}			

Status_Type

Status_Type is a 3 bit enumerated type that indicates the status information the Digital Terminal should return.

enum Status_Type	{ Status_Only=0, ADDRESS_PARAMS, ERROR_PARAMS, PHYSICAL_LAYER_PARAMS, RESERVED 4..7 };
------------------	--

Frequency_Included

This bit indicates if the frequency on which the terminal should respond is included in the message. If the frequency is not included, the terminal will randomly pick from available upstream frequencies on what frequency to respond.

Response_Frequency

If this field is included, it is used to indicate on what frequency the terminal should respond. Note: This frequency must be in the Contention Channel List message which the terminal is using or the message will be discarded.

7.5.3.8. <MAC> STATUS RESPONSE MESSAGE

The <MAC> STATUS RESPONSE MESSAGE is sent by the Digital Terminal in response to the <MAC> STATUS REQUEST MESSAGE issued by the headend. The contents of the information provided in this message will vary depending on the request made by the headend and the state of the Digital Terminal.

Status_Response_Message(){	Bits	Bytes	Bit Number/ Description
Digital_Terminal_Status	32	4	{enum}
Response_Fields_Included		1	
Reserved	5		7..3
Address_Params_Included	1		2:{no,yes}
Error_Information_Included	1		1:{no,yes}
Physical_Layer_Params_Included	1		0:{no,yes}
if (Address_Params_Included==yes) {			
MAC_Address	48	6	
IP_Address	32	4	
Return_Path_Id	16	2	
Downstream_Path_Id	16	2	
}			
if (Error_Information_Included==yes) {			
Number_Error_Codes_Included	8	1	
for(i=0;			
i<Number_Error_Codes_Included;i++){			
Error_Param_Code	8	1	
Error_Param_Value	16	2	
}			
}			
if (Physical_Layer_Params_Included==yes) {			
Power_Control_Setting	8	1	
MAC_Transmission_Mode	8	1	{enum}
Polling_Frequency	32	4	
}			
}			

Digital_Terminal_Status

Digital_Terminal_Status is a 32-bit enumerated type that indicates the current state of the Digital Terminal.

enum Digital_Terminal_Status	{ Signing_On_Service_Channel, Signing_On_Backup_Channel, Signing_On_Upstream_Verification, Interactive_Running, Tranmission_Stopped, Reserved 5..2 ³² -1 };
------------------------------	---

Response_Fields_Included

Response_Fields_Included is an 8 bit unsigned integer that indicates what parameters are contained in the upstream status response.

Address_Parameters:

MAC_Address

MAC_Address is a 6 byte address assigned to the Digital Terminal.

IP_Address

This is the 32 bit IP Address assigned to the terminal.

Return_Path_Id, Downstream_Path_Id

These are the path identifications of the terminal.

Error Parameters:

Number_of_Error_Codes_Included

Number_Error_Codes_Included is an 8-bit unsigned integer that indicates the number of error codes are contained in the response.

Error_Param_Code

Error_Param_Code is an 8-bit enumerated type representing the type of error reported by the Digital Terminal.

```
enum Error_Param_Code {      TBD,  
                          Reserved    1..255  };
```

Error_Param_Value

Error_Param_Value is a 16-bit unsigned integer representing error counts detected by the Digital Terminal.

Physical Parameters:

Power_Control_Setting

Power_Control_Setting is an 8-bit unsigned integer representing the absolute power attenuation that the Digital Terminal is using for upstream transmission

MAC_Transmission_Mode

This parameter will indicate if the terminal has had its upstream transmission stopped by the headend via a <MAC> Transmission Control message or not.

```
Enum_MAC_Transmission_Mode { Transmission Stopped=0,  
                             Transmission Allowed,  
                             Reserved    2..232-1 };
```

Polling_Frequency

This is the polling frequency assigned to the terminal for the NRC poll responses. It will have been configured by the NRC.

7.5.3.9. <MAC> LOGICAL ADDRESS MESSAGE

The <MAC> LOGICAL ADDRESS MESSAGE is sent to the Digital Terminal from the headend to configure address types supported by the Digital Terminal.

Logical_Address_Message(){	Bits	Bytes	Bit Number / Description
Address_Fields_Included		1	
Network_Addr_Included	1		7 {no,yes}
Multicast40_Included	1		6: {no, yes}
Multicast24_Included	1		5: {no, yes}
Multicast16_Included	1		4: {no, yes}
Return_Path_Id_Included	1		3: {no, yes}
UPM_Address_Included	1		2: {no,yes}
IP Address Included	1		1: {no,yes}
reserved	1		
if (Network_Addr_Included == yes) {			
Network_Address	40	5	
}			
if (Multicast40_Included == yes) {			
Multicast40_Address	40	5	
}			
if (Multicast24_Included == yes) {			
Multicast24_Address	24	3	
}			
if (Multicast16_Included == yes) {			
Multicast16_Address	16	2	
}			
If (Return_Path_Id_Included == yes) {			
Return_Path_Id	16	2	
}			
if (UPM_Address_Included == yes) {			
UPM_Address	24	3	
}			
if (IP_Address_Included == yes) {			
IP_Address	32	4	
}			
}			

Address_Fields_Included

This field specifies which addresses will be set by this message. Each bit corresponds to a different address type. Address types include the 40 bit network address, the 40, 24 and 16 bit multicast addresses, and a 32bit IP Address. The return path a terminal occupies may also be conveyed in this message. If the Upstream MAC Address is included in this message, the UPM_Address_Included flag will be set to 1.

Following this field are the actual address fields.

7.5.3.10. <MAC>CONTENTION CHANNEL LIST MESSAGE

The <MAC> CONTENTION CHANNEL LIST MESSAGE is broadcast periodically to the Digital Terminals. Digital Terminals operating with frequency hopping enabled on the upstream will use this list to determine which upstream channels are available for their use. All Digital Terminals using contention channels use this list to determine the appropriate backoff parameters for a particular channel.

Contention_Channel_List_Message(){	Bits	Bytes	Bit Number / Description
Message_Format_Field		1	
Explicit_Frequencies_Included	1		7 {no,yes}
Return_Path_Id_Included	1		6 {no,yes}
Backoff_Parameters_Included	1		5 {no,yes}
Reserved	5		4..0
if (Return_Path_Id_Included==yes)			
Return_Path_Id;	16	2	
if (Backoff_Parameters_Included==yes){			
Time_Unit;	16	2	in µsec
Xmax;	8	1	
Cell_Abort_Count;	8	1	
Max_Acknowledgment_Time;	8	1	in units of 10msec
Backoff_Bias;	8	1	
MAC_Abort_Count;	8	1	
}			
Number_of_Channels_Listed;	8	1	
for (i=0;i<Number_of_Channels_Listed;++i){			
Channel_Format_Field[i]		1	
Frequency_Hopping_Allowed	1		7 {no,yes}
Reserved	7		6..0
if(Explicit_Frequencies_Included==yes)			in Hz
Upstream_Frequency[i];	32	4	
Else			
Upstream_Channel_Number[i];	8	1	
}			
}			

Message_Format_Field

The Message_Format_Field has bits to indicate whether or not this message contains the explicit frequency (in Hz) or upstream frequencies, or refers to those frequencies by a channel number. Also indicated in the Message_Format_Field is whether or not backoff algorithm parameters are included which apply to these upstream frequencies, and whether or not a Return_Path_Id is included in this message. The presence of a Return_Path_Id field would indicate that this message is for one particular return path.

Return_Path_Id

Specifies which return path this message applies to. Only included if the appropriate bit is set in the Message_Format_Field.

Time_Unit, Xmax, Cell_Abort_Count, Max_Acknowledgment_Time, Backoff_Bias, MAC_Abort_Count

These parameters are used by the binary exponential backoff algorithm in the Digital Terminal.

Number_of_Channels_Listed

This field indicates how many contention channels are described in this message.

Channel_Format_Field

Frequency_Hopping_Allowed

For each channel described in the message, the Frequency_Hopping_Allowed bit indicates if Frequency Hopping is allowed on the channel (i.e. if frequency hopping Digital Terminals may hop onto this frequency. Frequencies in the <MAC> CONTENTION CHANNEL LIST MESSAGE which do not have this bit set may have terminals on them that do not employ frequency hopping. (For the initial version of the ALOHA MAC, the only frequencies in this list will be those with frequency hopping enabled.)

Upstream_Frequency

This field indicates a valid upstream frequency in Hz to use.

Upstream_Channel_Number

This field indicates a valid upstream channel to use for frequency hopping.

7.5.3.11. <MAC>ACKNOWLEDGE/POWER ADJUST MESSAGE

The <MAC> ACKNOWLEDGE/POWER ADJUST MESSAGE is sent to a Digital Terminal to acknowledge the receipt of one or more upstream MAC cells and to optionally have the Digital Terminal make a change to its transmitting power. This message is sent using singlecast addressing to a Digital Terminal.

Acknowledge/Power_Adjust_Message(){	Bits	Bytes	Bit Number / Description
Acknowledge_Field		1	
Ack_or_Nak	1		7 (0=ack,1=nak)
Message_Number	2		(6,5)
Sequence Number	5		(4..0)
Power_Control_Setting	8	1	
}			

Acknowledge_Field

The most significant bit of this byte indicates whether this is a positive acknowledgment or a negative acknowledgment. The following 7 bits correspond to the message number and sequence number being acknowledged or not-acknowledged.

Power_Control_Setting

Power_Control_Setting is an 8-bit signed integer to be used to set the new upstream power level of the Digital Terminal. A positive value represents an increase of the output power level.

$\text{new output_power_level} = \text{current output_power_level} + \text{power_control_setting} * 0.5 \text{ dB}$