

SCTE | **STANDARDS**

Network Operations Subcommittee

SCTE OPERATIONAL PRACTICE

SCTE 285 2023

DOCSIS 3.1 RxMER PNM Test Validation

NOTICE

The Society of Cable Telecommunications Engineers (SCTE) Standards and Operational Practices (hereafter called “documents”) are intended to serve the public interest by providing specifications, test methods and procedures that promote uniformity of product, interoperability, interchangeability, best practices, and the long term reliability of broadband communications facilities. These documents shall not in any way preclude any member or non-member of SCTE from manufacturing or selling products not conforming to such documents, nor shall the existence of such standards preclude their voluntary use by those other than SCTE members.

SCTE assumes no obligations or liability whatsoever to any party who may adopt the documents. Such adopting party assumes all risks associated with adoption of these documents and accepts full responsibility for any damage and/or claims arising from the adoption of such documents.

NOTE: The user’s attention is called to the possibility that compliance with this document may require the use of an invention covered by patent rights. By publication of this document, no position is taken with respect to the validity of any such claim(s) or of any patent rights in connection therewith. If a patent holder has filed a statement of willingness to grant a license under these rights on reasonable and nondiscriminatory terms and conditions to applicants desiring to obtain such a license, then details may be obtained from the standards developer. SCTE shall not be responsible for identifying patents for which a license may be required or for conducting inquiries into the legal validity or scope of those patents that are brought to its attention.

Patent holders who believe that they hold patents which are essential to the implementation of this document have been requested to provide information about those patents and any related licensing terms and conditions. Any such declarations made before or after publication of this document are available on the SCTE web site at <https://scte.org>.

All Rights Reserved
© 2023 Society of Cable Telecommunications Engineers, Inc.
140 Philips Road
Exton, PA 19341

Document Tags

| | | |
|---|------------------------------------|---|
| <input type="checkbox"/> Specification | <input type="checkbox"/> Checklist | <input type="checkbox"/> Facility |
| <input checked="" type="checkbox"/> Test or Measurement | <input type="checkbox"/> Metric | <input checked="" type="checkbox"/> Access Network |
| <input type="checkbox"/> Architecture or Framework | <input type="checkbox"/> Cloud | <input checked="" type="checkbox"/> Customer Premises |
| <input type="checkbox"/> Procedure, Process or Method | | |

Document Release History

| Release | Date |
|---------------|----------------|
| SCTE 285 2023 | <i>8/28/23</i> |

Note: Standards that are released multiple times in the same year use: a, b, c, etc. to indicate normative balloted updates and/or r1, r2, r3, etc. to indicate editorial changes to a released document after the year.

Table of Contents

| Title | Page Number |
|---|-------------|
| NOTICE..... | 2 |
| Document Tags..... | 3 |
| Document Release History | 3 |
| Table of Contents | 4 |
| 1. Introduction..... | 7 |
| 1.1. Executive Summary | 7 |
| 1.2. Scope | 7 |
| 1.3. Benefits | 7 |
| 1.4. Intended Audience | 7 |
| 1.5. Areas for Further Investigation or to be Added in Future Versions..... | 8 |
| 2. Normative References | 8 |
| 2.1. SCTE References | 8 |
| 2.2. Standards from Other Organizations | 8 |
| 2.3. Other Published Materials | 8 |
| 3. Informative References | 8 |
| 3.1. SCTE References | 8 |
| 3.2. Standards from Other Organizations | 8 |
| 3.3. Other Published Materials | 8 |
| 4. Compliance Notation | 10 |
| 5. Abbreviations and Definitions..... | 10 |
| 5.1. Abbreviations..... | 10 |
| 5.2. Definitions..... | 12 |
| Procedure..... | 12 |
| 6. Test Procedure for CM RxMER Validation | 12 |
| 6.1. Test Scenario | 12 |
| 6.2. Topology..... | 13 |
| 6.2.1. Equipment Setup and Configuration | 13 |
| 6.3. Receiver Fidelity Testing Procedure | 13 |
| 7. Validating the Sensitivity of the CM RxMER via Signal Analysis..... | 17 |
| 7.1. Test Scenario | 17 |
| 7.2. Configuration..... | 17 |
| 7.3. Table Column Definition..... | 18 |
| 7.3.1. Profile | 18 |
| 7.3.2. Vector Signal Analyzer RxMER | 18 |
| 7.3.3. PNM RxMER..... | 18 |
| 7.3.4. SNR..... | 18 |
| 7.3.5. IP Data Throughput (THRUPUT)..... | 18 |
| 7.4. Test Results | 19 |
| 7.5. Recap | 19 |
| 8. OFDM Modulation Profile Transition | 21 |
| 8.1. Test Scenario | 21 |
| 8.2. Configuration..... | 22 |
| 8.3. Table 11 Column Definition..... | 22 |
| 8.3.1. Profile | 22 |
| 8.3.2. PNM RxMER..... | 22 |
| 8.3.3. AWGN | 23 |
| 8.3.4. Throughput (THRUPUT)..... | 23 |
| 8.4. Test Results | 23 |
| 8.5. Profile Transition Results | 24 |

9. Conclusion..... 24

Appendix A..... 25

 A.1. DOCSIS 3.1 Fundamentals and Definitions..... 25

 A.1.1. Additive White Gaussian Noise..... 25

 A.1.2. SNR vs. RxMER..... 25

 A.1.3. Coding Gain and Noise Immunity Techniques..... 27

 A.1.3.1. LDPC..... 27

 A.1.3.2. BCH..... 28

 A.1.3.3. Interleaver 28

 A.1.3.3.1 Frequency Interleaver 29

 A.1.3.3.2 Time Interleaver 29

 A.1.3.4. Gray Code..... 29

 A.1.3.5. Cyclic Prefix and Micro-reflections..... 30

 A.1.3.6. Summary..... 32

Appendix B. Background and Theory..... 34

 B.1. DOCSIS 3.1 Modulation Profile Selection is not Driven by the CM with the Lowest SNR in the HFC Plant..... 34

 B.1.1. Downstream Modulation Profile 34

 B.1.1.1. Profile Selection and Transition 34

 B.1.2. Modulation Profiles..... 34

 B.1.3. Conclusion..... 37

Appendix C..... 38

 C.1. PNM OFDM DS Receive Modulation Error Ratio 38

 C.1.1. PNM Data Retrieval Call Flow..... 38

 C.1.2. RxMER Theory of Operation..... 38

 C.1.3. RxMER Analysis 40

List of Figures

| Title | Page Number |
|---|-------------|
| Figure 1 - Network Topology - Validating the Sensitivity of the CM RxMER via Signal Analysis..... | 13 |
| Figure 2 - Network Topology..... | 17 |
| Figure 3 - Test 4 RxMER per Subcarrier – Satisfactory for 4K-QAM | 19 |
| Figure 4 - Test 4 RxMER Mean and Standard Deviation – Suitable for 4K-QAM | 20 |
| Figure 5 - Test 5 RxMER vs Frequency - 4K-QAM CM Rx Sensitivity @ 35.6 dB RxMER | 20 |
| Figure 6 - Test 5 RxMER Standard Derivation - 4K-QAM RxMER Threshold @ 35.6 dB | 20 |
| Figure 7 - Test 10 RxMER vs Frequency - 1K-QAM RxMER Threshold @ 30.3 dB..... | 21 |
| Figure 8 - Test 10 RxMER Standard Derivation - 1K-QAM RxMER Threshold @ 30.3 dB | 21 |
| Figure 9 - Network Topology – OFDM Modulation Profile Testing | 22 |
| Figure 10 - Signal Insertion into an AWGN Channel | 25 |
| Figure 11 - System Overview of obtaining RxMER..... | 26 |
| Figure 12 - Slicer Decision Boundaries and Hard/Soft Decision Determinations | 27 |
| Figure 13 - Data Packet with BCH and LDPC Headers..... | 28 |
| Figure 14 - ISI Inter-symbol Interference [N. Instrument] | 30 |
| Figure 15 - Cyclic Prefix Example [OFDM] | 30 |
| Figure 16 - Three Echo Micro-reflection Example | 31 |
| Figure 17 - RxMER Probability Density Function Graph, courtesy of David Urban, Comcast | 35 |
| Figure 18 - Standard Deviation Gaussian Distribution Graph..... | 35 |

Figure 19 - PNM Server Process Example [SCTE 220-3] 38
 Figure 20 - RxMER DOCSIS Implementation Process..... 39
 Figure 21 - Error Vector Diagram..... 39
 Figure 22 - RxMER Response - Signal Ingress 40
 Figure 23 - RxMER Distribution indicating Skewness – Skewness of -3.19..... 41
 Figure 24 - RxMER Distribution of an AWGN Channel 41
 Figure 25 - RxMER Response – Micro-Reflection 42
 Figure 26 - RxMER Subcarrier Distribution - Micro-Reflection - Skewness of -0.19 42
 Figure 27 - RxMER Response – Micro-Reflection 43
 Figure 28 - RxMER Distribution – Micro-Reflection - Skewness of -0.36 43
 Figure 29 - Multiple Signal Ingress 44
 Figure 30 - RxMER Distribution - Skewness of -2.26 44

List of Tables

| Title | Page Number |
|---|-------------|
| Table 1 - Test Equipment..... | 13 |
| Table 2 - Receiver Fidelity Testing Procedure..... | 13 |
| Table 3 - CMTS OFDM Configuration..... | 18 |
| Table 4 - Sensitivity of the CM RxMER via Signal Analysis Summary Results..... | 19 |
| Table 5 - CMTS OFDM Configuration..... | 22 |
| Table 6 – Combined SC-QAM and OFDM Profile-Specific Test Results | 23 |
| Table 7 - OFDM Modulation Profile Transition 1024-QAM and 4096-QAM Re-Test..... | 23 |
| Table 8 - Natural Binary Sequence vs. Gray Code Sequence | 29 |
| Table 9 - Cyclic Prefix Lookup Table | 31 |
| Table 10 - CP Subcarrier Efficiency @ 4096-QAM..... | 32 |
| Table 11 - AWGN vs. Non-AWGN Example Profile Transition..... | 36 |
| Table 12 - AWGN vs. Non-AWGN Profile PDF Fit..... | 36 |
| Table 13 - AWGN vs. Non-AWGN Profile Allocation per PDF in the Example..... | 37 |

1. Introduction

1.1. Executive Summary

DOCSIS[®] 3.1 (D3.1) offers a new physical layer based on orthogonal frequency division multiplexing (OFDM) technology and more powerful forward error correction (FEC).

DOCSIS 3.1 also enables new analysis techniques using receive modulation error ratio (RxMER) per subcarrier and other proactive network maintenance (PNM) features. This Operational Practice provides insight into the capabilities and limitations of D3.1 cable modem (CM) RxMER measurements in comparison to traditional test equipment. The procedure for determining the sensitivity of cable modem RxMER measurements is described. Some results for accuracy are presented and expectations are discussed.

1.2. Scope

DOCSIS 3.1 PNM offers a diverse set of new test features to quickly and accurately characterize the effects of HFC impairments on the OFDM signals to optimize throughput and reliability of service. These features were previously only available in test equipment such as spectrum, vector, and network analyzers. Given the adaptive nature of DOCSIS 3.1 coupled with HFC network impairments, accurate measurements using these new 3.1 PNM tools are essential to creating modulation profile performance models. In particular, deep insight into the network health can be determined by using the DOCSIS 3.1 PNM feature downstream RxMER per subcarrier to determine the OFDM signal fidelity at the cable modem. This Operational Practice document summarizes the steps to confirm the accuracy of a CM's reported RxMER values.

1.3. Benefits

The following procedure is intended to help provide a better understanding of the capabilities and limitations when using DOCSIS 3.1 PNM measurements in lieu of traditional test equipment. Obtaining good statistical analysis is predicated on the CM's ability to measure RxMER accurately. It is up to the cable operator to repeat the procedures outlined in this document and test the CM's RxMER accuracy with each code version and new product. The procedures in this operational practice are based upon research which demonstrated that first generation DOCSIS 3.1 CMs and cable modem termination systems (CMTSS) can do a precise RxMER measurement sometimes similar to a quality lab analyzer.¹

It is necessary for operators to understand the limits of using such measurements. While there is a great potential to improve operational efficiency, it is also possible that incorrect measurements or interpretation could have the opposite effect on efficiency.

1.4. Intended Audience

The intended audience includes development engineers, test engineers, and technical operations personnel.

¹Dr. R. Prodan, "Demystifying the DOCSIS 3.1 PHY", 2014 SCTE-ISBE Cable-Tec Expo proceedings

1.5. Areas for Further Investigation or to be Added in Future Versions

None.

2. Normative References

The following documents contain provisions which, through reference in this text, constitute provisions of this document. The editions indicated were valid at the time of subcommittee approval. All documents are subject to revision and, while parties to any agreement based on this document are encouraged to investigate the possibility of applying the most recent editions of the documents listed below, they are reminded that newer editions of those documents might not be compatible with the referenced version.

2.1. SCTE References

No normative references are applicable.

2.2. Standards from Other Organizations

No normative references are applicable.

2.3. Other Published Materials

No normative references are applicable.

3. Informative References

The following documents might provide valuable information to the reader but are not required when complying with this document.

3.1. SCTE References

[SCTE 220-1] ANSI/SCTE 220-1 2022, DOCSIS 3.1 Part 1: Physical Layer Specification

[SCTE 220-3] ANSI/SCTE 220-3 2022, DOCSIS 3.1 Part 3: Cable Modem Operations Support System Interface-Specification

[SCTE 270] SCTE 270 2021, Mathematics of Cable

3.2. Standards from Other Organizations

No informative references are applicable.

3.3. Other Published Materials

[Babu] S. Babu and R. Rao, Evaluation of BER for AWGN, Rayleigh and Rician Fading Channels under Various Modulation Schemes, vol. 26, International Journal of Computer Applications (0975 – 8887), 2011.

[Gregorio] F. H. Gregorio, 802.11A - OFDM PHY CODING AND INTERLEAVING, Helsinki University of Technology.

- [NCTU] Available: http://cwww.ee.nctu.edu.tw/course/channel_coding/chap5.pdf.
- [Kaiser] S. Kaiser, OFDM Code-Division Multiplexing in Fading Channels, vol. 50, IEEE TRANSACTIONS ON COMMUNICATIONS, 2002.
- [Deshmukh] S. Deshmukh, R. Bagadia, P. Kapoor and D. Gohil, OFDM-MIMO AND V-BLAST ALGORITHM-KEY TO HIGH SPEED WIRELESS COMMUNICATION, vol. 4, 2013, pp. 426-440.
- [N. Instrument] N. Instrument, "Pulse-Shape Filtering in Communications Systems," 05 Nov 2014. [Online]. Available: <http://www.ni.com/white-paper/3876/en/>.
- [OFDM] sharetechnote, "Communication - OFDM," [Online]. Available: http://www.sharetechnote.com/html/Communication_OFDM.html. [Accessed June 2016].
- [Costello] D. Costello and D. Forney, Channel Coding: The Road to Channel Capacity, Proceedings of the IEEE, 2007, p. 1150.
- [Maxson] B. Maxson, "Validating and Troubleshooting OFDM," in Society of Cable Telecommunications Engineers, 2013.
- [ETSI] European Telecommunications Standards Institute, DVB-C2 Digital Video Broadcasting, 2015.
- [Hranac] R. Hranac and B. Currivan, "Digital Transmission: Carrier-to-Noise Ratio, Signal-to-Noise Ratio, and Modulation Error Ratio," Cisco, 2006.
- [Prodan] Dr. R. Prodan, "Demystifying the DOCSIS 3.1 PHY", 2014 SCTE·ISBE Cable-Tec Expo proceedings.

4. Compliance Notation

| | |
|-------------------|---|
| <i>shall</i> | This word or the adjective “ <i>required</i> ” means that the item is an absolute requirement of this document. |
| <i>shall not</i> | This phrase means that the item is an absolute prohibition of this document. |
| <i>forbidden</i> | This word means the value specified <i>shall</i> never be used. |
| <i>should</i> | This word or the adjective “ <i>recommended</i> ” means that there <i>may</i> exist valid reasons in particular circumstances to ignore this item, but the full implications <i>should</i> be understood and the case carefully weighed before choosing a different course. |
| <i>should not</i> | This phrase means that there <i>may</i> exist valid reasons in particular circumstances when the listed behavior is acceptable or even useful, but the full implications <i>should</i> be understood and the case carefully weighed before implementing any behavior described with this label. |
| <i>may</i> | This word or the adjective “ <i>optional</i> ” indicate a course of action permissible within the limits of the document. |
| deprecated | Use is permissible for legacy purposes only. Deprecated features <i>may</i> be removed from future versions of this document. Implementations <i>should</i> avoid use of deprecated features. |

5. Abbreviations and Definitions

5.1. Abbreviations

| | |
|--------|--|
| AWGN | additive white Gaussian noise |
| BER | bit error ratio |
| BCH | Bose-Chaudhuri-Hocquenghem [code] |
| bps | bits per second |
| b/sym | bits per symbol |
| BPSK | binary phase shift keying |
| CP | cyclic prefix |
| CNR | carrier-to-noise ratio |
| CM | cable modem |
| CMTS | cable modem termination system |
| CRC | cyclic redundancy check |
| dB | decibel |
| dBmV | decibel millivolt |
| DOCSIS | Data-Over-Cable Service Interface Specifications |
| D3.1 | DOCSIS 3.1 |
| DS | downstream |
| DUT | device under test |
| EVM | error vector magnitude |
| FEC | forward error correction |
| FI | frequency interleaver |

| | |
|---------|--|
| Gbps | gigabits per second |
| GHz | gigahertz |
| HFC | hybrid fiber/coax |
| HTTP | Hypertext Transfer Protocol |
| Hz | hertz |
| I | in-phase |
| ISI | inter-symbol interference |
| kbps | kilobits per second |
| KPI | key performance indicator |
| LCI | LDPC code iteration |
| LDPC | low-density parity check |
| LTE | long term evolution |
| Mbps | megabits per second |
| MHz | megahertz |
| OPT-REQ | OFDM downstream profile test request |
| OFDM | orthogonal frequency division multiplexing |
| PDF | probability density function |
| PDU | payload data unit |
| PLC | PHY link channel |
| PNM | proactive network maintenance |
| PMA | profile management application |
| MER | modulation error ratio |
| MP | modulation profile |
| NA | network analyzer |
| NCP | next codeword pointer |
| NPR | noise power ratio |
| PHY | physical layer |
| RF | radio frequency |
| RxMER | receive modulation error ratio |
| SA | spectrum analyzer |
| SCTE | Society of Cable Telecommunications Engineers |
| SC-QAM | single carrier quadrature amplitude modulation |
| SDN | software defined network |
| SG | service group |
| SNR | signal-to-noise ratio |
| SNMP | simple network management protocol |
| TI | time interleaver |
| Q | quadrature |
| QAM | quadrature amplitude modulation |
| QPSK | quadrature phase shift keying |
| VSA | vector signal analyzer |

5.2. Definitions

Definitions of terms used in this document are provided in this section. Defined terms that have specific meanings are capitalized. When the capitalized term is used in this document, the term has the specific meaning as defined in this section.

No definitions are applicable.

Procedure

6. Test Procedure for CM RxMER Validation

6.1. Test Scenario

This test is to compare the CM's ability to measure the RxMER accurately at the CM receiver compared to RxMER measurement results provided by a lab quality signal analyzer.

Some terminology and definitions are helpful in defining the test procedures. RxMER is a measurement made within CMs, and is defined for OFDM in [SCTE 220-1]. There is a discussion of the DOCSIS RxMER in Appendix C. SNR in this document refers to the ratio between the signal power spectral density (PSD) and noise PSD at the input to the CM, such as can be measured with a spectrum analyzer. RxMER and SNR are typically very close in value but RxMER is subject to more sources of degradation than can be detected by SNR measurements. Some sources of link degradation which are measured by RxMER but are not captured in the SNR measurement at the CM input include:

1. transmitter phase noise and symbol clock jitter not tracked by the CM receiver;
2. intermodulation distortion in the signal at the input to the CM (typically from amplifiers in the chain from the modulator to the CM input);
3. phase noise and symbol clock jitter introduced by the CM, thermal noise added by the CM, electromagnetic interference picked up within the CM, digital processing noise, and nonlinear distortion generated within the CM.

CNR, carrier-to-noise ratio, is defined in Table 46 of [SCTE 220-1] for specification of downstream OFDM CM error ratio performance in AWGN. CNR is very close to SNR for most OFDM channel configurations.

6.2. Topology

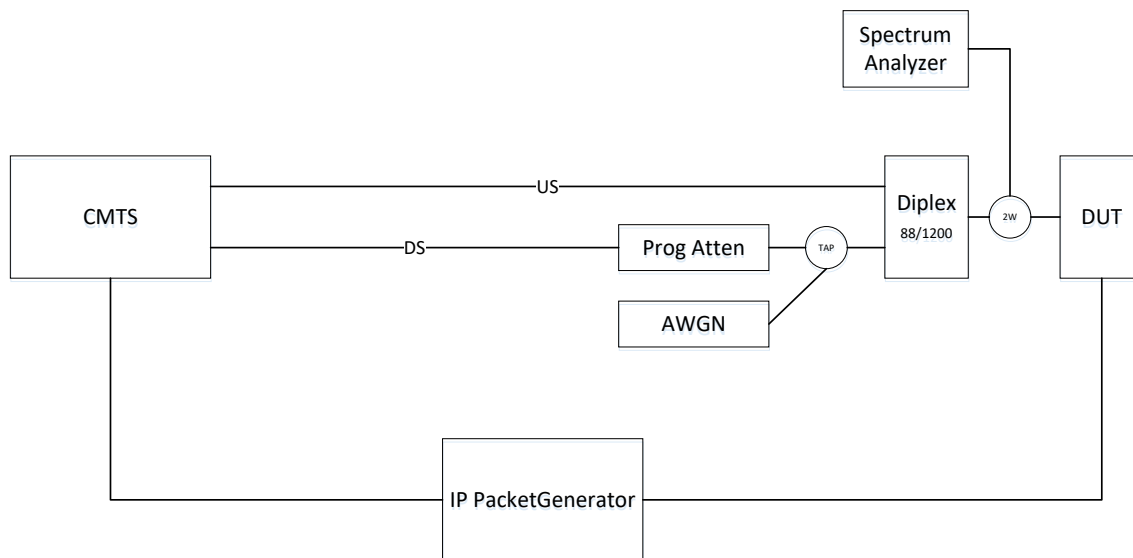

Figure 1 - Network Topology - Validating the Sensitivity of the CM RxMER via Signal Analysis

6.2.1. Equipment Setup and Configuration

Table 1 lists the equipment needed for this test and describes the setup and configuration requirements.

Table 1 - Test Equipment

| Equipment | Configuration |
|----------------------------|-----------------------------|
| DUT (cable modem) | |
| CMTS | |
| RF programmable attenuator | DC – 1.2 GHz 0 dB to 100 dB |
| AWGN source | DC to 2 GHz |
| PNM analyzer tool | |
| TFTP server | |
| DHCP server | |
| IP packet generator | |

6.3. Receiver Fidelity Testing Procedure

Follow the steps detailed in Table 2 to test the fidelity of the receiver.

Table 2 - Receiver Fidelity Testing Procedure

| Procedure A | Operation with SC-QAM and OFDM downstream signals without externally generated AWGN | Test Result |
|-------------|---|-------------|
| Step 1 | Establish test setup as shown in Figure 1. | |

| | | |
|--------------------|--|--------------------|
| Step 2 | Configure IP packet generator as defined in Table 5 | |
| Step 3 | Configure CMTS as defined in Table 3 | |
| Step 4 | Verify SC-QAM input power level @ 0 dBmV ± 2 dB | |
| Step 5 | Verify spectrum loading flatness, no more than ± 5 dB tilt | |
| Step 6 | Verify OFDM channel input power level @ 0 dBmV across OFDM band | |
| Step 7 | Connect and power up DUT and start timer | |
| Step 8 | Verify DUT registration and stop timer | Pass/Fail |
| Step 9 | Verify DUT Registration time is less than 30 seconds | Pass/Fail |
| Step 10 | Verify DUT subscribes to the CMTS-configured profile | Pass/Fail |
| Step 11 | Verify DUT no FEC correctable and FEC-uncorrectable are incrementing | Pass/Fail |
| Step 12 | Start IP packet generator | |
| Step 13 | <i>Verify Throughput Parameters</i> | |
| | Downstream throughput ~ 1 Gbps | Pass/Fail |
| | Upstream throughput ~100 Mbps | Pass/Fail |
| Procedure B | Operation with SC-QAM and OFDM downstream signals over change of RF power without externally generated AWGN | Test Result |
| Step 1 | Connect test setup as shown in Figure 1. | |
| Step 2 | Configure IP packet generator as defined in Table 5 | |
| Step 3 | Configure CMTS as defined in Table 3 | |
| Step 4 | Verify spectrum loading flatness ± 5 dB positive/negative tilt. | |
| Step 5 | Verify SC-QAM input power level @ 0 dBmV ± 2 dB | |
| Step 6 | Verify OFDM channel input power level @ 0 dBmV across OFDM band | |
| Step 7 | Connect and power up DUT and start timer | |
| Step 8 | Verify DUT registration and stop timer | Pass/Fail |
| Step 9 | Verify DUT registration time is less than (n) seconds, as defined by test requirements * | Pass/Fail |
| Step 10 | Verify DUT subscribes to the CMTS-configured profile | Pass/Fail |

| | | |
|--------------------|---|--------------------|
| Step 11 | Verify DUT No FEC correctable and FEC-uncorrectable are incrementing | Pass/Fail |
| Step 12 | Start IP packet generator | |
| Step 13 | <i>Verify Throughput Parameters</i> | |
| | Downstream Throughput ~ 1 Gbps | Pass/Fail |
| | Upstream Throughput ~100 Mbps | Pass/Fail |
| Step 14 | Increase attenuation by 1 dB per 30 seconds | |
| Step 15 | Verify DUT registration and did not reset | Pass/Fail |
| Step 16 | Verify DUT subscribes to CMTS-configured profile | Pass/Fail |
| Step 17 | Verify DUT no FEC correctable and FEC-uncorrectable are incrementing | Pass/Fail |
| Step 18 | Repeat Steps 13 through 18 until SC-QAM input power level reaches -12 dBmV | |
| Step 19 | <i>Verify Throughput Parameters</i> | |
| | Downstream throughput ~ 1 Gbps | Pass/Fail |
| | Upstream throughput ~100 Mbps | Pass/Fail |
| Step 20 | Decrease attenuation by 1 dB per 30 seconds | |
| Step 21 | Verify DUT registration and did not reset | Pass/Fail |
| Step 22 | Verify DUT subscribes to CMTS-configured profile | Pass/Fail |
| Step 23 | Repeat Steps 19 through 22 until SC-QAM input power level reaches +15 dBmV | |
| Procedure C | Operation with SC-QAM and OFDM downstream signals over change of RF power and AWGN | Test Result |
| Step 1 | Connect test setup as shown in Figure 1 | |
| Step 2 | Configure IP Packet Generator as defined in Table 5 | |
| Step 3 | Configure CMTS as defined in Table 3 | |
| Step 4 | Verify spectrum loading flatness ± 5 dB positive/negative tilt. | |
| Step 5 | Verify SC-QAM input power level @ 0 dBmV ± 2 dB | |
| Step 6 | Verify OFDM channel input power level @ 0 dBmV across OFDM band | |
| Step 7 | Connect and power up DUT and start timer | |
| Step 8 | Verify DUT registration and stop timer | Pass/Fail |

| | | |
|---------|---|------------------|
| Step 9 | Verify DUT registration time is less than (n) seconds, as defined by test requirements * | Pass/Fail |
| Step 10 | Verify DUT subscribes to CMTS-configured profile | Pass/Fail |
| Step 11 | Verify DUT FEC correctable and FEC-uncorrectable errors are not incrementing | Pass/Fail |
| Step 12 | Start IP packet generator | |
| Step 13 | <i>Verify Throughput Parameters</i> | |
| | Downstream throughput ~ 1 Gbps | Pass/Fail |
| | Upstream throughput ~100 Mbps | Pass/Fail |
| Step 14 | Set input spectrum power level to +12 dBmV | |
| Step 15 | Set AWGN to achieve RxMER/SNR of 41.0 dB @ 4K-QAM | |
| Step 16 | Perform OFDM signal channel power-to-noise measurement with a spectrum analyzer and verify 41.0 dB +/- 0.5 dB | |
| Step 17 | Use the PNM MIB (MeasuredAvgMer) to obtain the average RxMER value | |
| Step 18 | (PNM MIB average RxMER) – (analyzer measurement) < 1 dB (note: there is no requirement in DOCSIS regarding the accuracy of this value) | Pass/Fail |
| Step 19 | Verify DUT FEC-uncorrectable < CER 10E-6 | Pass/Fail |
| Step 20 | <i>Verify Throughput Parameters</i> | |
| | Downstream throughput ~ 1 Gbps @ 92% of provision rate | Pass/Fail |
| Step 21 | Set input spectrum power level to -12 dBmV | |
| Step 22 | Reset CM and verify registration | |
| Step 23 | Set AWGN to achieve RxMER/SNR of 41.0 dB @ 4K-QAM | |
| Step 24 | Perform OFDM signal channel power-to-noise measurement with Spectrum Analyzer and verify 41.0 dB +/- 0.5dB | |
| Step 25 | Use the PNM MIB (MeasuredAvgMer) to obtain the average RxMER value | |
| Step 26 | (PNM MIB average RxMER) – (analyzer measurement) < 1 dB (note: there is no requirement in DOCSIS regarding the accuracy of this value) | Pass/Fail |

| | | |
|---------|---|-----------|
| Step 27 | Verify DUT FEC-uncorrectable < CER 10E-6 | Pass/Fail |
| | <i>Verify Throughput Parameters</i> | |
| Step 28 | Downstream Throughput ~ 1 Gbps | Pass/Fail |
| Step 29 | Repeat Procedure C Steps 1 - 28 for 2K-, and 1K-QAM | |

* Test requirements may vary depending on individual goals and sensitivity of the respective test cases.

7. Validating the Sensitivity of the CM RxMER via Signal Analysis

7.1. Test Scenario

This test is to compare the CM’s ability to measure the RxMER accurately at the receiver front end versus a lab quality signal analyzer.² The signal analyzer was configured to perform spectrum, vector, and DOCSIS OFDM analysis. If PNM-based metrics are to be used moving forward for critical plant repairs and improvements, this evaluation is essential to determine the performance and assessment of the OFDM signal fidelity from the perspective of the CM. Furthermore, RxMER analysis via PNM file transfer is performed and compared to the signal analysis against controlled network impairments.

Note: At the time of testing, the acquisition of RxMER data was not averaged, which may have resulted in variation or noise in the measured RxMER.

7.2. Configuration

The test configuration is depicted in Figure 2 and described in Table 3.

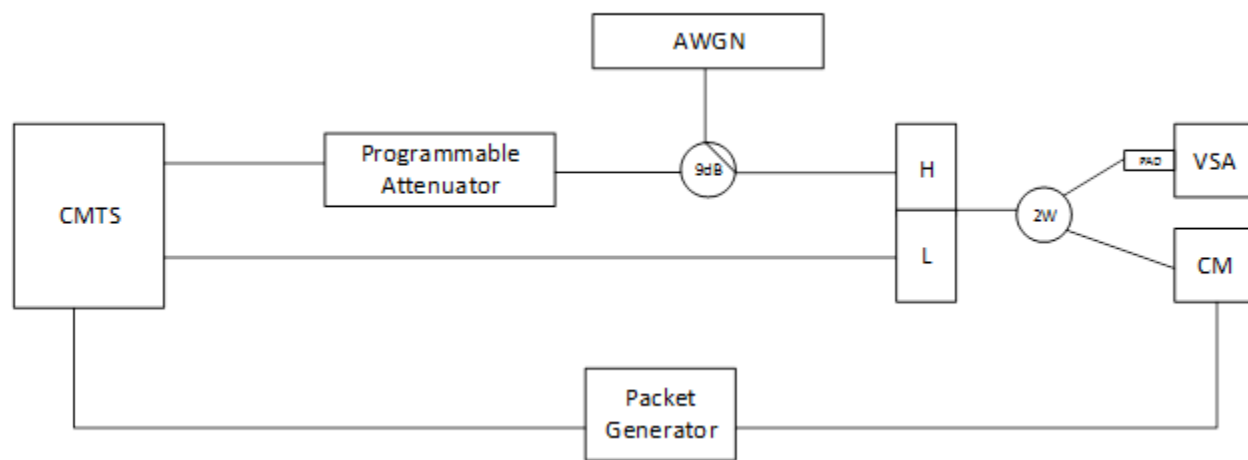

Figure 2 - Network Topology

² The DOCSIS 3.1 PHY specification does not have an absolute accuracy requirement or specification for RxMER values reported by cable modems. That said, reported values tend to be very good, although with a lower sensitivity than commercial VNAs.

Table 3 - CMTS OFDM Configuration

| CMTS OFDM Configuration | | | |
|---------------------------------------|--------------|--|--------------|
| OFDM 96 MHz (BW) (Tests 1 – 6) | | OFDM 96 MHz (BW) (Tests 7 – 11) | |
| Start Frequency | 786 MHz | Start Frequency | 786 MHz |
| Stop Frequency | 882 MHz | Stop Frequency | 882 MHz |
| PLC | 832 MHz | PLC | 832 MHz |
| Profile A | 4096-QAM | Profile A | 1024-QAM |
| Cyclic Prefix | 1024 Samples | Cyclic Prefix | 1024 Samples |
| Roll-Off | 256 Samples | Roll-Off | 256 Samples |
| Single Carrier QAM | | Single Carrier QAM | |
| Center Frequency | 663 MHz | Center Frequency | 663 MHz |

CMTS OFDM frequency selection is based on current field trial deployment configuration.

7.3. Table Column Definition

7.3.1. Profile

Due to dynamic modulation profile, only one modulation profile, Profile-A, will be used to prevent transition between profiles. This evaluation will include 4096-QAM and 1024-QAM modulation profiles.

7.3.2. Vector Signal Analyzer RxMER

The VSA uses DOCSIS decoding software to demodulate and evaluate OFDM modulation profiles, BER, LDPC/BCH FEC decode statistics and RxMER.

7.3.3. PNM RxMER

The RxMER is obtained from the cable modem by using the DOCSIS PNM file retrieval method. Analysis of the data is performed to determine the mean and standard deviation of RxMER.

7.3.4. SNR

SNR is measured using the spectrum analysis function of the VSA.

$$SNR_{Relative} \cong OFDM_{ChannelPower} - AWGN_{ChannelPower}$$

7.3.5. IP Data Throughput (THRUPUT)

100 concurrent HTTP sessions were generated during the test using an IXIA IxLoad measured in Mbps.

7.4. Test Results

Table 4 - Sensitivity of the CM RxMER via Signal Analysis Summary Results

| TEST | PROFILE-A | | VSA RxMER (dB) | PNM RxMER (dB) | SNR (dB) | THRUPUT (Mbps) |
|------|-----------|--|----------------|----------------|----------|----------------|
| 1 | 4K-QAM | | 46.0 | 43.2 | 46 | 773 |
| 2 | 4K-QAM | | 38.0 | 37.9 | 38 | 773 |
| 3 | 4K-QAM | | 37.1 | 37.2 | 37 | 773 |
| 4 | 4K-QAM | | 36.7 | 36.4 | 36 | 773 |
| 5 | 4K-QAM | | 36.4 | 35.6 | 35 | 340 |
| 6 | 4K-QAM | | 36.18 | - | 34 | - |
| 7 | 1K-QAM | | 35.0 | 34.2 | 35 | 651 |
| 8 | 1K-QAM | | 33.2 | 33.2 | 34 | 651 |
| 9 | 1K-QAM | | 32.4 | 31.3 | 33 | 651 |
| 10 | 1K-QAM | | 30.71 | 30.3 | 30 | 651 |
| 11 | 1K-QAM | | - | - | 29 | - |

In Test 6 and Test 11, the SNR was low enough that the cable modems were unable to pass traffic.

7.5. Recap

The results of the above test verified the accuracy of the CM’s ability to compute all subcarriers’ RxMER and using the average or mean RxMER; the results were in most cases within 1 dB or so of a lab quality vector analyzer, until the sensitivity of the cable modem became a factor (above 40 dB).

Test 4, 5 and 10 are represented in Figure 3 through Figure 8 using the PNM MIB to plot the respective values.

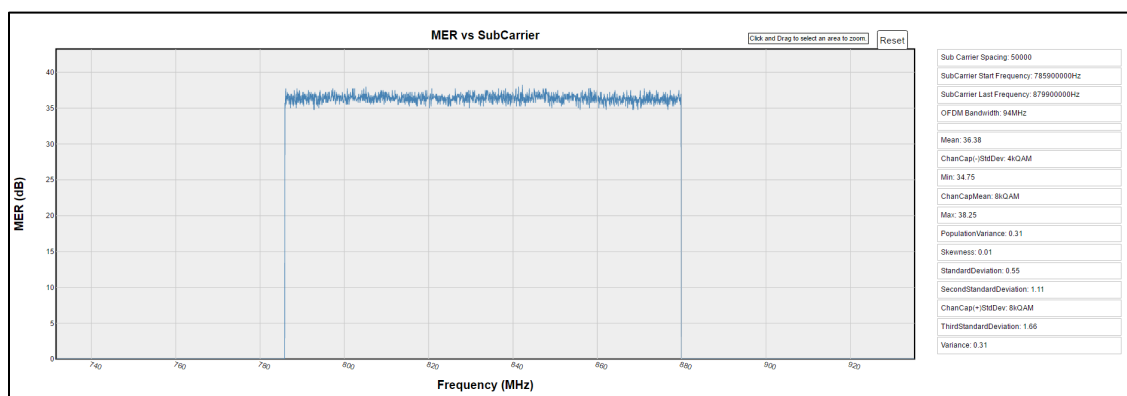

Figure 3 - Test 4 RxMER per Subcarrier – Satisfactory for 4K-QAM

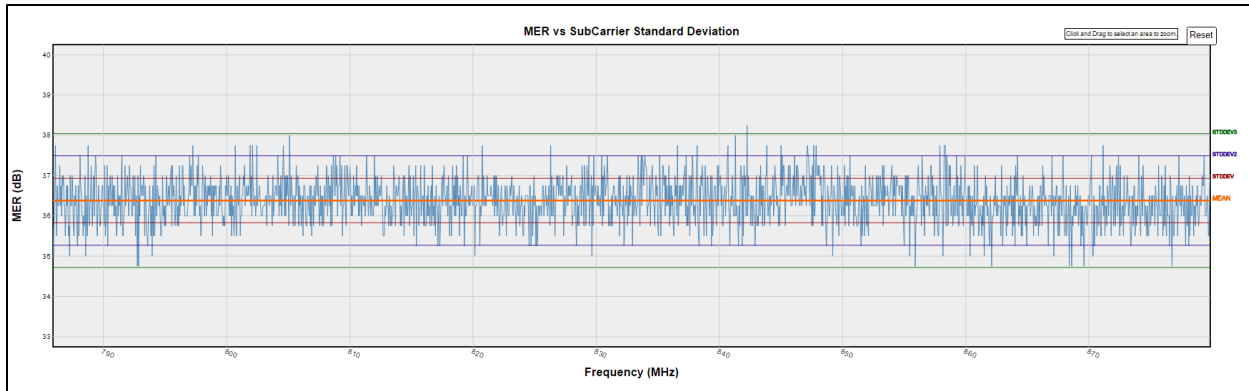

Figure 4 - Test 4 RxMER Mean and Standard Deviation – Suitable for 4K-QAM

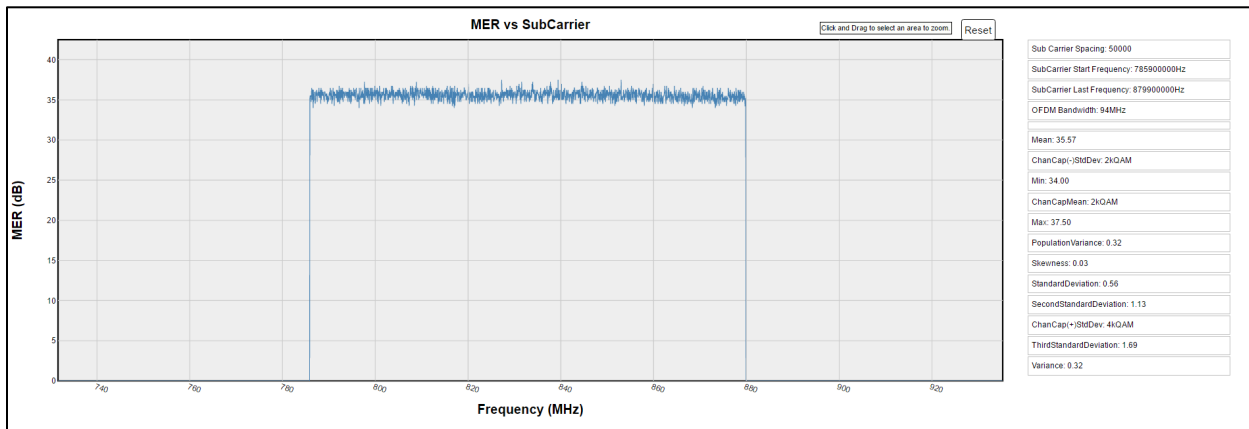

Figure 5 - Test 5 RxMER vs Frequency - 4K-QAM CM Rx Sensitivity @ 35.6 dB RxMER

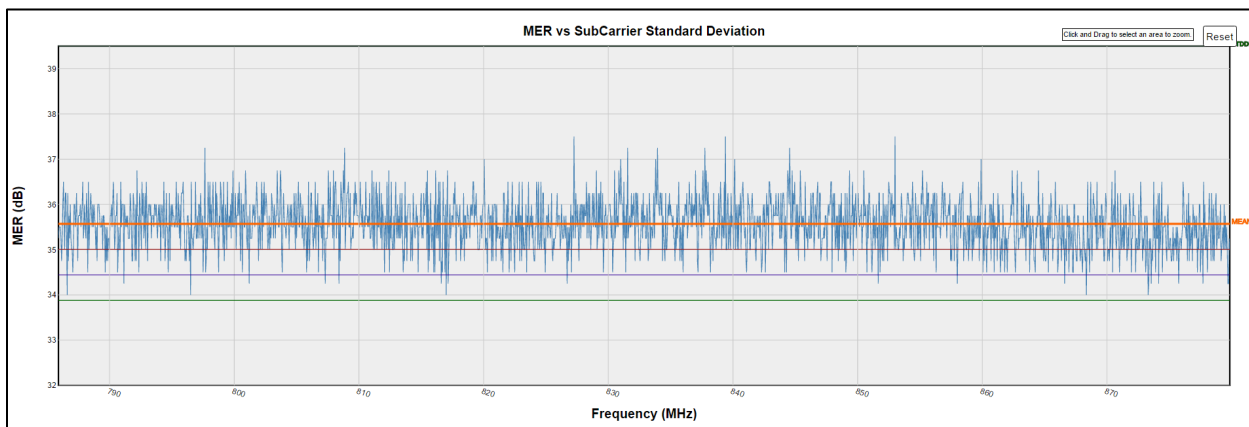

Figure 6 - Test 5 RxMER Standard Derivation - 4K-QAM RxMER Threshold @ 35.6 dB

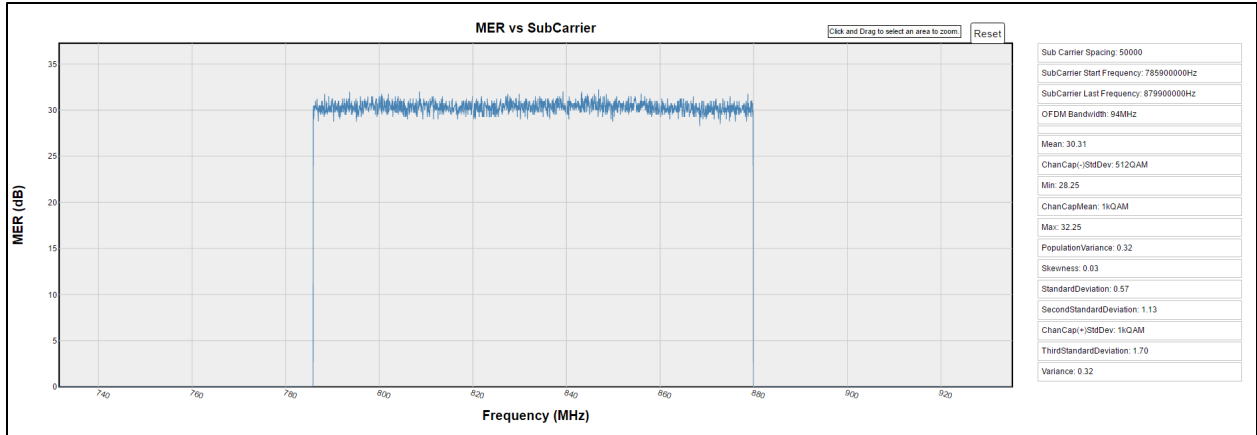

Figure 7 - Test 10 RxMER vs Frequency - 1K-QAM RxMER Threshold @ 30.3 dB

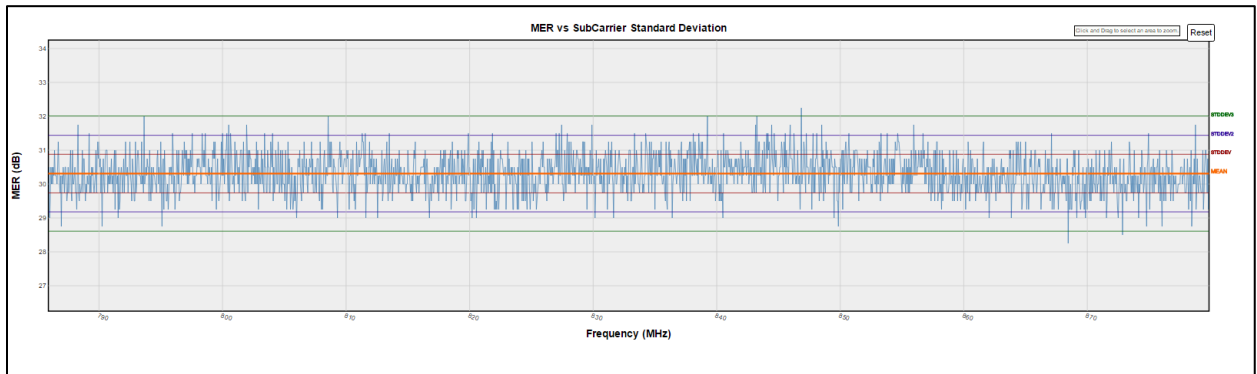

Figure 8 - Test 10 RxMER Standard Derivation - 1K-QAM RxMER Threshold @ 30.3 dB

8. OFDM Modulation Profile Transition

8.1. Test Scenario

This test is to verify the OFDM profile transitions in an AWGN channel. At the time of this test, only three profiles were used since not all D3.1 features were supported on the test hardware.

8.2. Configuration

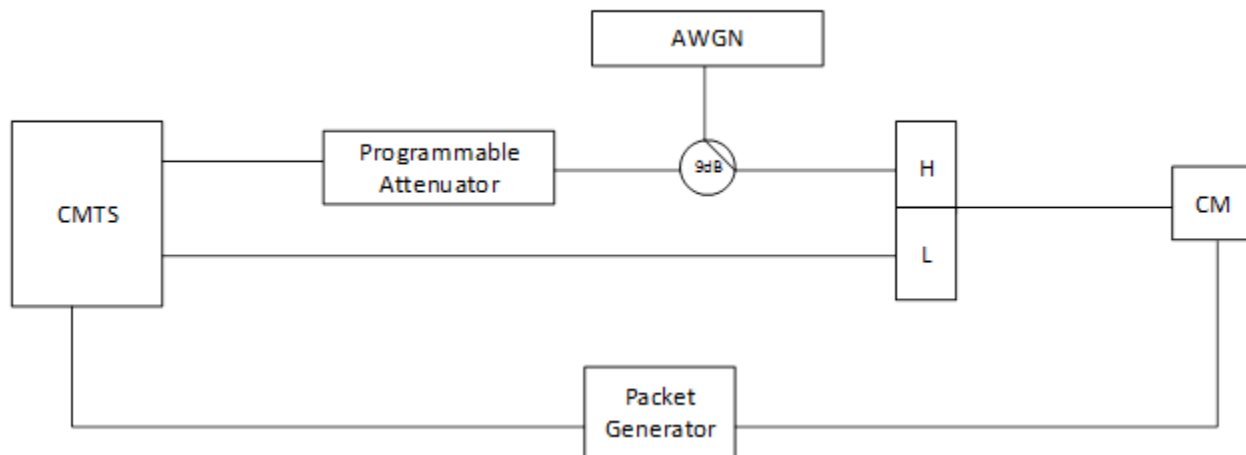

Figure 9 - Network Topology – OFDM Modulation Profile Testing

Table 5 - CMTS OFDM Configuration

| CMTS OFDM Configuration | |
|--------------------------------|--------------------|
| OFDM 96 MHz (BW) | |
| Start Frequency | 786 MHz |
| Stop Frequency | 882 MHz |
| PLC | 832 MHz |
| Profile A | 256-QAM |
| Profile B | 1024-QAM |
| Profile C | 4096-QAM |
| Cyclic Prefix | 1024 Samples |
| Roll-Off | 256 Samples |
| 24 x Single Carrier QAM | |
| Center Frequency | 597 MHz to 735 MHz |

8.3. Table 11 Column Definition

8.3.1. Profile

This value is the highest profile assigned to the CM reported by the CMTS.

8.3.2. PNM RxMER

The RxMER data is collected using the DOCSIS PNM TFTP file download method. Analysis of the data is performed to determine the mean and standard deviation of the RxMER.

8.3.3. AWGN

The dB value is the noise generator attenuation value relative to 0 dB over the frequency range 100 Hz to 1 GHz. These values were empirically determined to achieve the desired RxMER values. Note: Attenuator for the AWGN generator is not shown in Figure 29.

8.3.4. Throughput (THRUPUT)

IP data throughput in Mbps for the combined SC-QAM and OFDM channels.

Note: 100 concurrent HTTP sessions were generated using the IXIA IxLoad measured in Mbps. The maximum throughput was 910 Mbps because of gigabit Ethernet port limitations.

8.4. Test Results

Table 6 – Combined SC-QAM and OFDM Profile-Specific Test Results

| TEST | OFDM PROFILE QAM | PNM RxMER (dB) | AWGN (dB) | THRUPUT (Mbps) |
|------|------------------|----------------|-----------|----------------|
| 1 | 4096 | 40.7 | - | 910 |
| 2 | 1024 | 37.36 | 37.0 | 910 |
| 3 | 1024 | 35.44 | 34.0 | 910 |
| 4 | 1024 | 31.50 | 31.0 | 910 |
| 5 | 1024 | 32.4 | 30.0 | 910 |
| 6 | 1024 | 31.54 | 29.0 | 910 |
| 7 | 1024 | 30.66 | 28.0 | 910 |
| 8 | 256 | 29.78 | 27.0 | 910 |
| 9* | 256 | 24.99 | 22.0 | 492 |
| 10* | 256 | 24.39 | 21.5 | 492 |
| 11* | 256 | 24.28 | 21.3 | 492 |
| 12* | 256 | 24.12 | 21.1 | 492 |
| 13 | 256 | - | - | - |

* During these tests, the SC-QAM signals @ 256-QAM using RS FEC were unable to correct errored codewords. Only the DS-OFDM was passing IP traffic at this point.

Table 7 - OFDM Modulation Profile Transition 1024-QAM and 4096-QAM Re-Test

| TEST | PROFILE QAM | PNM RxMER (dB) | AWGN (dB) | THRUPUT (Mbps) |
|------|-------------|----------------|-----------|----------------|
| 1 | 4096 | 40.24 | 40 | 910 |
| 2 | 4096 | 39.13 | 38 | 910 |
| 3 | 4096 | 38.40 | 37 | 910 |
| 4 | 4096 | 37.72 | 36 | 910 |
| 5* | 1024 | 36.88 | 35 | 910 |

Table 12 summarizes a retest of the previous test due to an expected transition from 4096-QAM to 1024-QAM. This test used a smaller increase of AWGN to determine the profile transition threshold.

*Test 5 throughput did not change because the total capacity including the additional 24 SC-QAM signals is greater than 910 Mbps shown, which is a limitation of the gigabit Ethernet port.

8.5. Profile Transition Results

This test verified a feature in which the CM and CMTS interaction successfully transitioned the CM to a lower profile. In Table 6 Test 7 the reported RxMER, before transitioning to 256-QAM, is 30.66 dB at 1024-QAM. The calculated minimum RxMER for 1024-QAM is 30.1 dB (refer to Table 3). In Table 7 Test 4 the reported RxMER before transitioning to 1024-QAM is 37.72 dB. The calculated minimum RxMER for 4096-QAM is 36.1 dB (refer to Table 3). This is a delta of 1.62 dB. When the RxMER dropped to within 1 dB of the calculated minimum given in Table 3 for the profile, the profile was transitioned.

9. Conclusion

The long-awaited promise of DOCSIS 3.1 has finally arrived with not just a significant improvement of spectral efficiency, but significantly enhanced and expanded tools embedded in the CM and CMTS that allow a cable operator to perform downstream signal analysis far beyond what is available today with DOCSIS 3.0 PNM. Even when only using RxMER we can project modulations profiles for a given service group. We can also determine when a CM population is experiencing signal ingress that has previously been hidden from spectrum analysis. Subsequently, a cable operator can develop custom modulation profiles using the RxMER discrete values with a resolution of 25 kHz or 50 kHz, depending on subcarrier spacing.

This document explored the sensitivity of the CM's ability to take precise RxMER measurements, and compares against a high-quality vector signal analyzer (VSA). The functions and features of a VSA are far more advanced than the capabilities of a CM. In practice the RxMER is measured after the demodulator and includes quantization and thermal noise error and one would expect a lower sensitivity of signal measurement. A VSA uses high-quality, low noise amplifier (LNA) and possibly higher resolution analog-to-digital converters (ADC). However, even with this clear distinction, the CM RxMER analysis can be within a fraction of a dB of the VSA except for high SNR conditions as shown in Table 6.

CMTS profile optimization algorithms may be based on the same PNM test options that are available in the DOCSIS PNM MIB. Cable operators have the ability to control the CM profile assignments using profile management techniques and tools.

In conclusion, obtaining good statistical analysis is predicated on the CM's ability to measure RxMER accurately. However, DOCSIS 3.1 CMs are intended as a commodity with a push to drive the cost down below that required to support accurate parameter measurement with the high sensitivity of a VNA. As such, compromises may be made, for example, to certain components that could affect measured parameter values. It is up to the cable operator to repeat this procedure and test the RxMER accuracy with each code version and new product. In this Operational Practice, it has been shown the first generation DOCSIS 3.1 CMs and CMTSs have the ability to do RxMER measurements that have useful accuracy but with a lower sensitivity than a quality lab VNA. The CM results were in most cases within 1 dB or so of a lab quality vector analyzer, until the sensitivity of the cable modem became a factor (above 40 dB).

Appendix A.

A.1. DOCSIS 3.1 Fundamentals and Definitions

This appendix contains a review of some fundamentals of signal processing and signal impairments that relate to the tests in this Operational Practice, along with some examples of how variables can be accessed in DOCSIS 3.1. Field trial examples are included to reveal the importance of PNM RxMER to the detection of signal ingress and its performance impact. Techniques are presented to measure and evaluate options to create and select an OFDM downstream profile and the impact on the OFDM signal with flat AWGN in a lab setting. In addition, real-world field studies supplement the lab results. For additional discussion about some of the topics discussed in this appendix (e.g., AWGN, data communication efficiency, Shannon capacity theory, etc.), refer to [SCTE 270].

A.1.1. Additive White Gaussian Noise

AWGN is commonly used to simulate background noise of a channel, thus resulting in what is called the AWGN channel. It is the basic communication channel model and used as a standard channel model. The transmitted signal gets impaired by the presence of AWGN [SCTE 270].

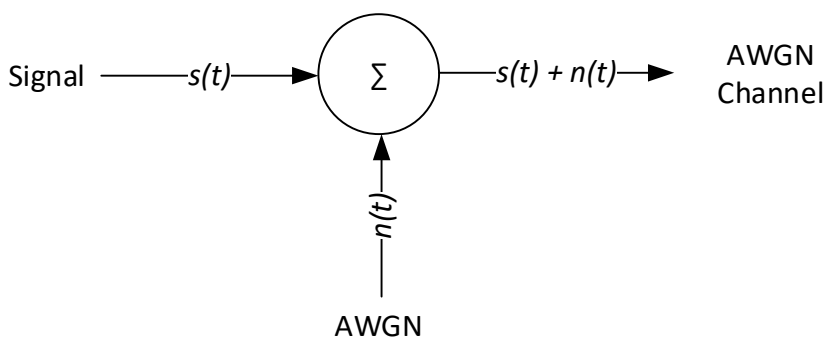

Figure 10 - Signal Insertion into an AWGN Channel

A.1.2. SNR vs. RxMER

The signal-to-noise ratio (SNR or S/N), is defined as the ratio of signal power to the noise power corrupting the signal. SNR is a measure of signal quality. Higher SNR values improve the likelihood of signal acquisition with minimal distortion and artifacts caused by noise. SNR is defined in several different ways in literature, but for our purposes in this document, SNR is defined as shown below.

$$SNR = \frac{E_s}{N_0} = \frac{\text{Energy per symbol}}{\text{Noise Power Spectral Density}}$$

Sometimes in literature, SNR is expressed in terms of energy per bit, but in this document we will always use the definition of SNR shown above; readers may refer to [SCTE 270] for discussion of alternative definitions of SNR.

SNR is used to describe a signal before demodulation. RxMER is the MER as measured in a digital receiver after demodulation. RxMER is defined as

$$RxMER_{dB} = 10 * \text{Log}_{10} \left[\frac{\sum_{j=1}^N (\tilde{I}_j^2 + \tilde{Q}_j^2)}{\sum_{j=1}^N [(I_j - \tilde{I}_j)^2 + (Q_j - \tilde{Q}_j)^2]} \right]$$

\tilde{I} = Ideal Inphase of Symbol (Hard Decision)

\tilde{Q} = Ideal Quadrature of Symbol (Hard Decision)

I = Recieve Inphase of Symbol (Soft Decision)

Q = Recieve Quadrature of Symbol (Soft Decision)

The equation shows the ideal IQ power divided by the difference between the actual received IQ component and the ideal IQ component. This difference is analogous to SNR, but includes quantization and thermal noise during the demodulation process [Hranac].

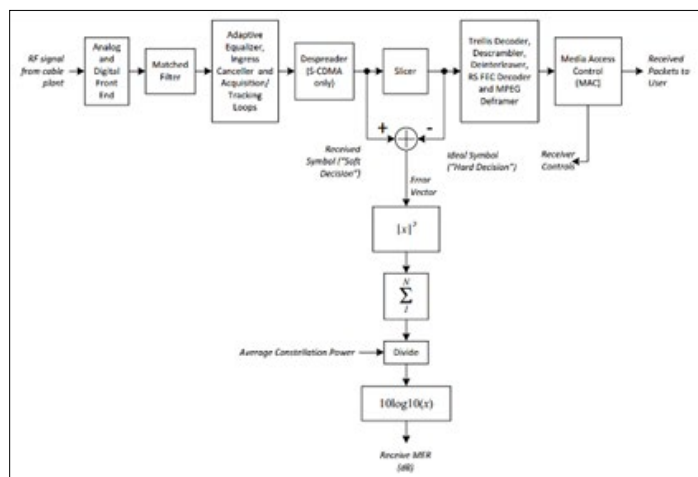

Figure 11 - System Overview of obtaining RxMER

RxMER is a measure of the signal quality at the slicer. The slicer is the element in the demodulator that is responsible for deciding which symbol was transmitted. This measurement is a fundamental metric for the communications link; these demodulated symbols form the input to the FEC decoder. Ideally, the FEC decoder removes the noise in the slicer, which is represented by the denominator in the RxMER equation. Larger RxMER results in better FEC decoder performance.

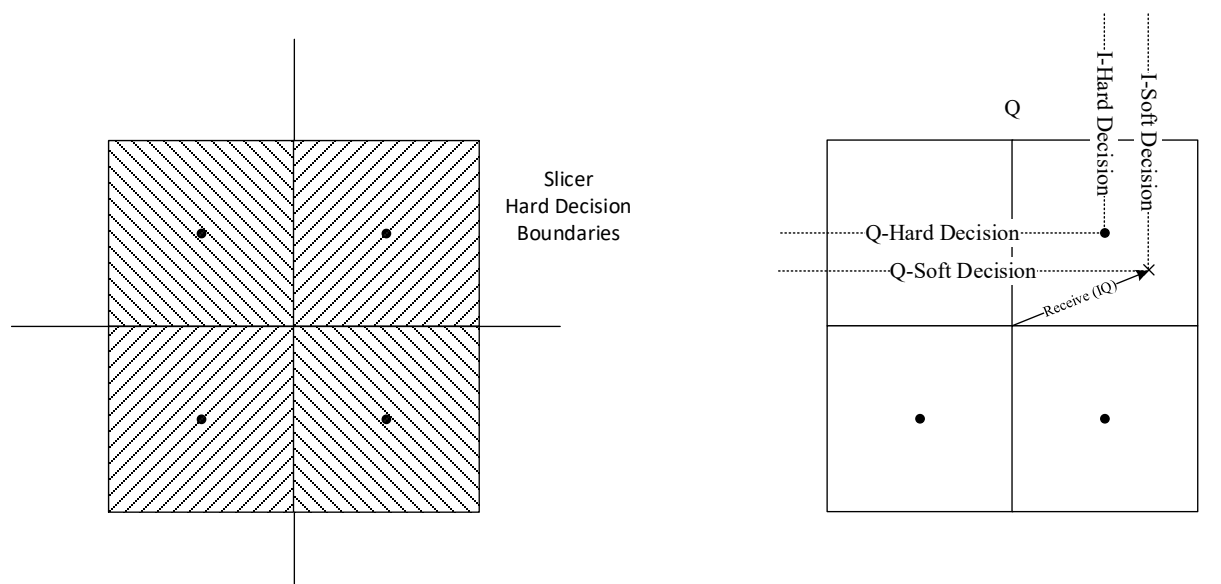

Figure 12 - Slicer Decision Boundaries and Hard/Soft Decision Determinations

A.1.3. Coding Gain and Noise Immunity Techniques

Channel coding is the process which compensates for impairment caused by channel noise. Digital communication aims to maximize the transmission bit rate while minimizing (a) probability of bit error; (b) required signal-to-noise ratio (SNR); and (c) system complexity. Coding gain is the difference in the SNR that is required to provide a sufficiently low bit error ratio (BER) with coding, compared to the SNR necessary for the desired BER without coding. When determining coding gain, care must be taken to normalize for spectral efficiency.

To improve the clearing of any errors that might occur, the FEC for DOCSIS 3.1 consists of a combination of the low-density parity check (LDPC) and Bose-Chaudhuri-Hocquenghem (BCH) code.

A.1.3.1. LDPC

Even if most OFDM subcarriers can be demodulated without errors, the overall BER may be dominated by a subset of subcarriers that have a low SNR. FEC coding is essential to compensate for any (a few) underperforming subcarriers if they have low signal fidelity, and to compensate for the expected occurrence of random noise, even with moderate to high SNR on most subcarriers, in order to achieve higher bit loading. Robert G. Gallager, in his doctoral dissertation at the Massachusetts Institute of Technology, developed the LDPC concept in 1960, which had been forgotten until 1994 due to the computational complexity needed to perform this operation. LDPC performance continues to improve towards the limits of Shannon theorem capabilities.

LDPC is a class of block codes, iteratively decoded, which reduces the number of faulty bits. LDPC is based upon a message-passing algorithm where probabilities are passed between check nodes and variable nodes. Variable nodes represent the probability of each bit in a codeword. Check nodes represent the parity checks used to determine if a codeword has been found. Messages are passed until a codeword is found.

A clean signal will take fewer iterations to find a codeword. A noisy signal may take many iterations to find a codeword. If the SNR is too low, no amount of iterations will find a codeword. The transition

between the SNR at which the received and corrected signal is error free and the SNR at which the signal can no longer be reconstructed is very narrow.

As with any FEC, there is a limit to the number of errors that can be corrected per packet; this is no different with LDPC. More time allotted to the LDPC decoding algorithm (per codeword) increases the number of iterations which the decoder can execute, thereby increasing the number of errors that can be corrected. The LDPC algorithm stops as soon as a codeword is found, generally indicating all errors are corrected. The number of iterations required to correct all errors provides a metric to assess the signal quality, but due to a multiplicity of real-world impairments, any of which may be present in different degrees or even in combination, the number of iterations metric is not sufficient to indicate margin. It must be noted that the number of iterations is also dependent on the implementation, and therefore, values measured for different receivers cannot be compared to one another.

A.1.3.2. BCH

BCH codes form a large class of multiple random error-correcting codes. They were first discovered by A. Hocquenghem in 1959 and independently by R. C. Bose and D. K. Ray-Chaudhuri in 1960. BCH codes are cyclic codes [NCTU]. BCH is capable of correcting residual errors following the LDPC decoding. The LDPC code selected for downstream DOCSIS 3.1, in AWGN, with a practical number of iterations, has a transition from high uncorrectable codewords to low uncorrectable codewords in a small SNR range, as mentioned previously. However, the “low” uncorrectable codeword ratio performance “flares” for high SNR, after reaching (dropping) to around an intended threshold. For this reason, it is important for this FEC to incorporate an outer code. In the case of DOCSIS, a BCH code was selected. BCH FEC is considered "clean up" after LDPC errors that cannot be corrected.

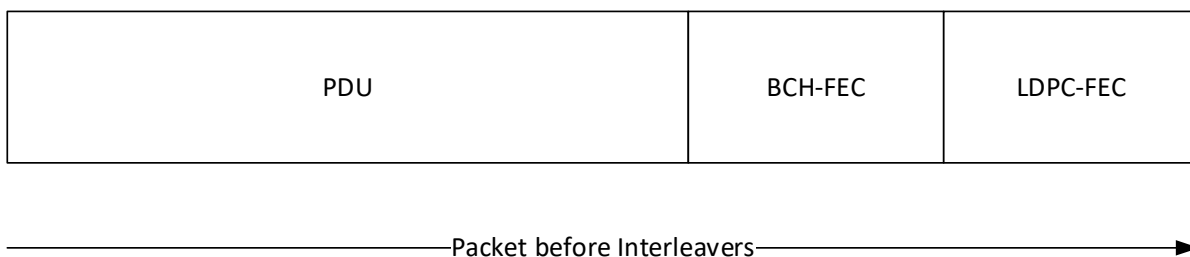

Figure 13 - Data Packet with BCH and LDPC Headers

Figure 13 illustrates the concept of inner (LDPC) and outer (BCH) concatenated FEC technique

A.1.3.3. Interleaver

Interleaving, in general, is an attempt to spread the errors out in the bit-stream that is presented to the error correction decoder. When decoders experience a high number of errors due to burst noise in the time domain (correlated errors in time) or due to narrowband radio frequency interference (correlated errors in the frequency domain), the decoder may be unable to correct all the bit errors. If interleaving is employed, after deinterleaving at the receiver the correlated bit errors are dispersed across many codewords so that each codeword has only a small fraction of bits in error. Using time domain interleaving, infrequent burst (time domain) errors can be spread among many codewords, where each may then be correctly decoded. Using frequency domain interleaving, narrowband interference (frequency domain) induced errors may be spread across many codewords and thus each may be correctly decoded.

DOCSIS 3.1 uses the two kinds of interleavers: frequency and time. Time interleaving (TI) needs long time delay for achieving good performance for long burst noise durations. On the other hand, frequency interleaving (FI) does not require a delay.

A.1.3.3.1 Frequency Interleaver

The frequency interleaving works along the frequency dimension. The FI changes the frequency locations of individual OFDM subcarriers; there are no latency effects, except for the data store and read latency. The aim of frequency interleaving is to disperse ingress. An example of this would be an LTE burst carrier that affects some consecutive subcarriers over the entire OFDM symbol [Kaiser].

Frequency interleaving distributes the burst-affected subcarriers over some number of LDPC codewords. FI also increases resistance to frequency-selective channel conditions such as fading. When a segment of the channel bandwidth fades, frequency interleaving provides a safeguard against bit errors because segments of the codewords would be distributed among subcarriers in frequencies not adjacent to the fading, and would spread out in the bit-stream rather than being concentrated.

A.1.3.3.2 Time Interleaver

From the DOCSIS 3.1 PHY spec: The DOCSIS 3.1 downstream time interleaving is a convolutional interleaver that operates in the time dimension on individual subcarriers of a sequence of OFDM symbols. The TI does not change the frequency location of any OFDM subcarrier. A burst event (time domain) can reduce the SNR of all the subcarriers of one or two consecutive OFDM symbols. The purpose of the TI is to disperse these burst-affected OFDM subcarriers between M successive OFDM symbols, where M is the interleaver depth. This dispersion distributes the burst-affected subcarriers uniformly over some number of LDPC codewords.

Time interleaving ensures that bits that are originally close together in the bit-stream are transmitted far apart in time, thus mitigating against long duration impulse noise [Deshmukh].

A.1.3.4. Gray Code

Gray code (GC) is a binary numeral system where two successive values differ in only one binary bit. When designing a constellation map, GC is part of the design. Mainly when assigning bits to a symbol, adjacent codewords should only have a small difference from each other. In other words, the constellation points that are close together differ in as few bits as possible. Gray code improves coding in case of an incorrect slicing so only one bit will be errored. The DOCSIS 3.1 square constellations (e.g., 16-QAM, 64-QAM, 256-QAM, 1024-QAM, 4096-QAM, 16384-QAM) are Gray coded; it is not possible to Gray code non-square constellations (32-QAM, 128-QAM, 512-QAM, 2048-QAM, 8192-QAM). However, the DOCSIS 3.1 non-square constellation symbol mappings are “almost” Gray coded to minimize the bit differences for the bit assignments in vertically and horizontally adjacent symbols in the constellation.

Table 8 - Natural Binary Sequence vs. Gray Code Sequence

| Binary | Gray Code |
|----------------------|----------------------|
| 0000 <- Start | 0000 <- Start |
| 0001 <- 1 Bit Change | 0001 <- 1 Bit Change |
| 0010 <- 2 Bit Change | 0011 <- 1 Bit Change |
| 0011 <- 1 Bit Change | 0010 <- 1 Bit Change |
| 0100 <- 3 Bit Change | 0110 <- 1 Bit Change |

A.1.3.5. Cyclic Prefix and Micro-reflections

The cyclic prefix (CP) is the repetition or a copy of part of the end of the symbol that is prepended to the beginning of the symbol. CP is needed to combat HFC multipath or micro-reflections. Micro-reflections are short time-delay reflections or echoes of signal that bounce back and forth between two impedance mismatches. This reflection or echo overlaps a small part of the next symbol and causes an impairment called inter-symbol interference (ISI).

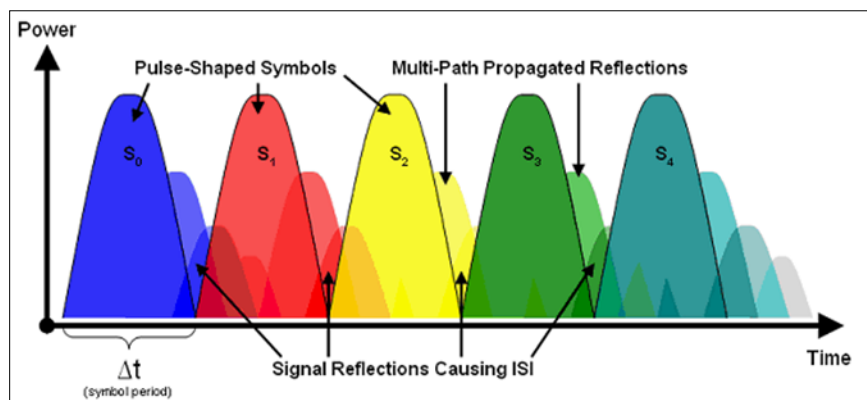

Figure 14 - ISI Inter-symbol Interference [N. Instrument]

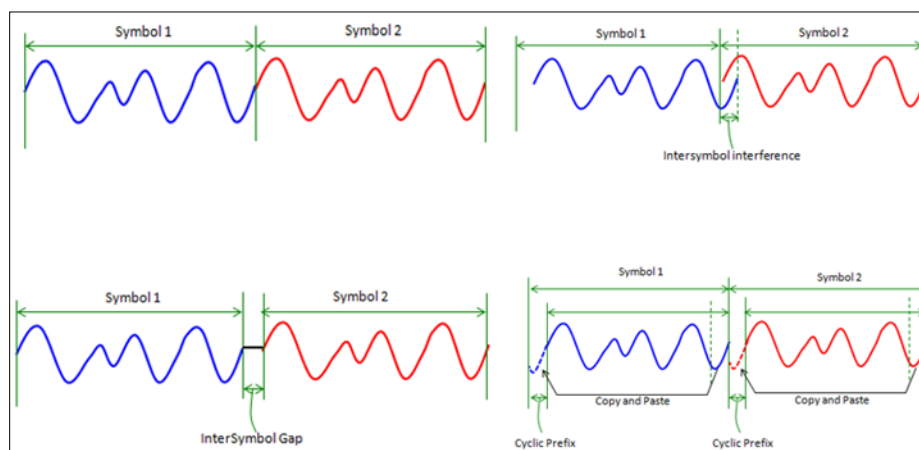

Figure 15 - Cyclic Prefix Example [OFDM]

A weakness of the CP is that it increases the symbol duration and will have an adverse impact on data throughput.

Using Figure 15 example of a micro-reflection, we can calculate an appropriate CP to mitigate the reflection.

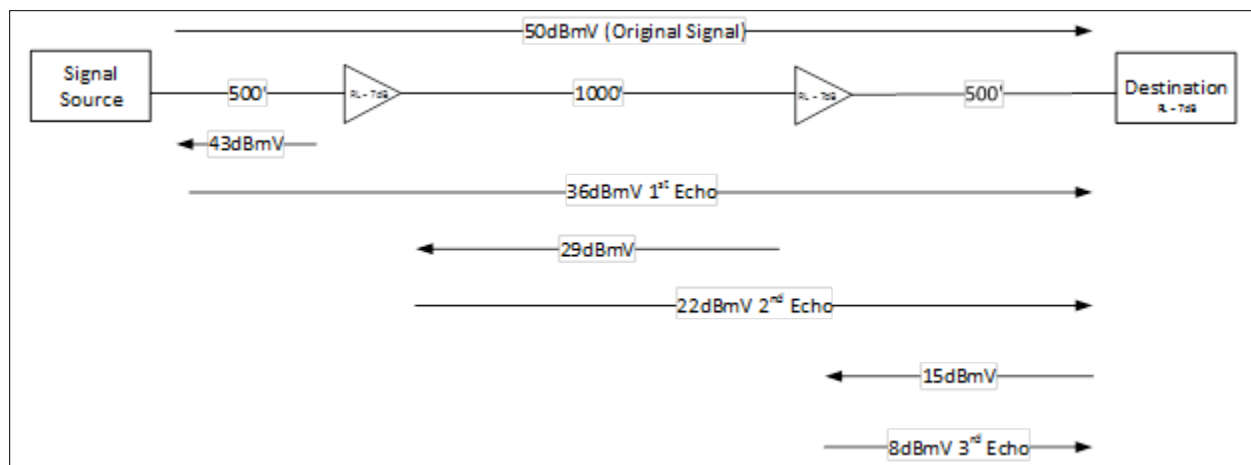

Figure 16 - Three Echo Micro-reflection Example

Assume 1 Foot \cong 1 ns (10^{-9}) is the approximate signal propagation delay. Taking the first echo to calculate a total echo delay

$$Delay_{FirstEcho} = (Distance) * (RoundTrip) * (Propagation Delay)$$

$$2000 * 2 * 10^{-9} = 4\mu s$$

Table 9 - Cyclic Prefix Lookup Table

| Cyclic Prefix Options | Delay | CP | Symbol Period |
|-----------------------|-----------|-----------|--|
| 0.9375 μs | 4 μs | 5 μs | @50 kHz = 25 μs @25 kHz = 45 μs |
| 1.25 μs | | | |
| 2.5 μs | | | |
| 3.75 μs | | | |
| 5 μs | | | |

Using the lookup table in Table 9, select the appropriate CP.

$$CP_{Selection} > Delay_{FirstEcho}$$

$$5 \mu s > 4 \mu s$$

To calculate the performance impact:

$$SymbolPeriod = \frac{1}{SubcarrierBW}$$

$$SymbolDuration = SymbolPeriod + CP_{Selection}$$

$$25 \mu s = 20 \mu s + 5 \mu s @ 50 kHz$$

$$45 \mu s = 40 \mu s + 5 \mu s @ 25 \text{ kHz}$$

$$Net \text{ Performance} = \frac{1}{SymbolDuration} * Log_2(M)$$

$$Performance = \frac{1}{Symbol \text{ Period}} * Log_2(M)$$

M = modulation scheme i.e. 256-QAM

$$Efficiency_{PerSubcarrier} = \frac{Net \text{ Performance}}{Performance} * 100$$

Table 10 - CP Subcarrier Efficiency @ 4096-QAM

| Calculations base on 4096-QAM | | | | |
|-------------------------------|-------------|-------------|-----------------|------------|
| Symbol Period | Performance | With CP | Net Performance | Efficiency |
| 25 kHz = 40 μs | 300 kbps | 5 μs | 266.7 kbps | 89% |
| | | 2.5 μs | 282.4 kbps | 94% |
| 50 kHz = 20 μs | 600 kbps | 5 μs | 480 kbps | 80% |
| | | 2.5 μs | 533.3 kbps | 89% |

In Table 9 determine the extended CP duration; it would be more efficient to use a 25 kHz subcarrier spacing as opposed to 50 kHz spacing.

A.1.3.6. Summary

The combined effect of interleaving and channel coding takes advantage of the frequency diversity provided by the wideband nature of the transmitted signal [Gregorio].

Because of the increased robustness of the channel due to improvement in code gain and interleaving, the OFDM channel can handle noise and impairments that would otherwise create an undesirable effect in the previous version of DOCSIS SC-QAM signals. If any portion of the SC-QAM signal faces interference from a foreign signal the entire signal can be unusable, depending on the severity of the interference.

More efficient error correction is achieved by replacing the Reed-Solomon algorithm used in DOCSIS 3.0 (and earlier) with the more powerful and more efficient LDPC algorithm. This enhancement alone provides an increase in performance of about 3 dB compared to Reed-Solomon. The same bits per second per hertz value is achieved with approximately 3 dB lower SNR.

The improved code gain with LDPC/BCH allows cable operators to leverage higher-order modulations which were not previously obtainable. Before DOCSIS 3.1, 256-QAM was the highest used modulation, but now operators can select modulation orders as high as 4096-QAM, and potentially as high as the optional 8196-QAM and 16384-QAM values, assuming the respective SNR levels are available to support their operation.

Appendix B. Background and Theory

B.1. DOCSIS 3.1 Modulation Profile Selection is not Driven by the CM with the Lowest SNR in the HFC Plant

B.1.1. Downstream Modulation Profile

B.1.1.1. Profile Selection and Transition

D3.1 OFDM profiles provide a broad range of modulation choices that can be used to fine-tune the CMTS transmissions to achieve the best performance from current network conditions. The option for multiple modulation profiles provides lower orders of modulation for those CMs with lower SNR and higher order modulations for modems with higher SNR. Roughly 3 dB additional SNR is required to support the next higher order of modulation in quadrature amplitude modulation (QAM). The reader is guided to Table 46 of [SCTE 220-1] which shows the required CNR (which is very close to SNR as measured on a spectrum analyzer) for each modulation order in an AWGN channel.

In practice, 256-QAM is the most common modulation order used for single carrier quadrature amplitude modulation (SC-QAM) DOCSIS and digital video signals. At 256-QAM an SNR of 28 dB to 30 dB using Reed-Solomon (RS) FEC coding is the lower limit of usable SNR (threshold). DOCSIS PHYv3.0 specifies performance at 30 dB carrier-to-noise ratio for SC-QAM input level to the CM of -6 dBmV or greater. With DOCSIS 3.1 OFDM subcarriers using 256-QAM, in AWGN in idealized lab conditions, quasi-error-free operation approaching 24 dB SNR may be possible with some CMs (the specification in AWGN is 27.0 dB). The improvement is due to the additional coding gain provided by LDPC/BCH FEC in D3.1. So, while an SNR of 28 dB in DOCSIS 3.0 (D3.0) could mean using 256-QAM, in D3.1 28 dB SNR means we might be able to assign subcarriers 512-QAM.

B.1.2. Modulation Profiles

D3.1 specifies that the CM must support a minimum of four modulation profiles. The profiles are called Profiles A through D for convenience. Profile-A is specified to be the most robust, meaning it should work in any network condition, i.e., when the network is at its minimum health level or alternately when the network conditions provide the minimum RxMER. In the case of using 256-QAM for Profile-A, this is a logical choice since D3.0 and video SC-QAM signals are both currently running robustly at 256-QAM in today's networks.

However, in D3.1, the CM must support constellations BPSK, QPSK, 16-, 256-, 512-, 1024-, 2048-, 4096-, and optionally 8192- and 16384-QAM. Moreover, while we cannot test these directly in D3.0, we can measure the SNR and map it to these modulation orders for profile specifications in DOCSIS. Capturing SC-QAM SNR over a particular service group (SG) will thus determine the best-starting profile. Using a well-publicized example of analysis by Dave Urban that gives the probability density function (PDF) of modem SNRs across the entire Comcast network, we can determine a case for a profile selection.³

³ The analysis results are in the graph shown in Figure 2. According to correspondence with Dave Urban, the results shown in the graph, while not published in an industry paper, were used at Comcast and in the CableLabs DOCSIS 3.1 PHY Working Group.

It should also be noted that the PDF represents 6 million modems over the Comcast footprint, and noted further that nearly identical results, within 1 dB of this PDF, have been observed by other cable operators and discussed in SCTE working groups. This PDF represents a valid industry benchmark circa 2010 to 2012 for current HFC network architectures, and is expected to further improve as fiber-deep, remote PHY and other advanced architectures are deployed. Hence this PDF curve is expected to reflect a typical, well-maintained cable network and can be used to design D3.1 profiles. For this Operational Practice, and with only limited samples of DOCSIS 3.1 cable modems, we are assuming the overall distribution and the service group distribution are expected to be similar.

The following tables provide an example of guidance for profile management based on optimistic radio frequency (RF) performance, and based on the SNR distribution in Figure 17. In practice, operators are recommended to do their own survey or measurement of SNR distribution in their CMs. Efficient use of SNR ranges shown in Table 11 provide a practical example of profiles for a given service group.

Note that the profile designation assumes all subcarriers use the same order of modulation and coding parameters.

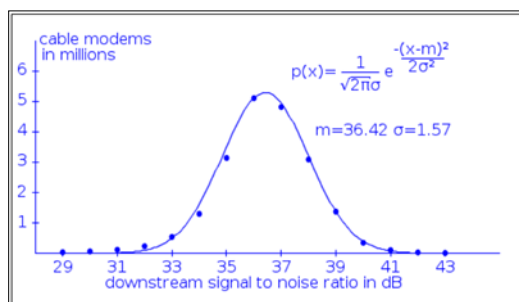

Figure 17 - RxMER Probability Density Function Graph, courtesy of David Urban, Comcast

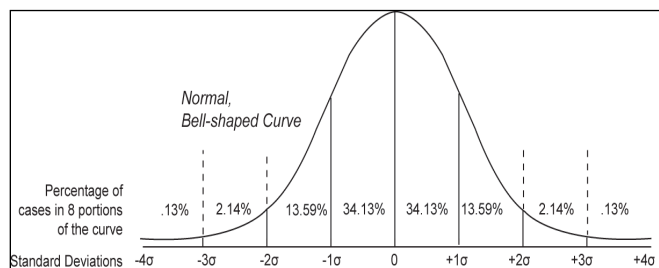

Figure 18 - Standard Deviation Gaussian Distribution Graph

Table 11 - AWGN vs. Non-AWGN Example Profile Transition

| M-QAM | Optimistic RxMER Min (dB) AWGN ⁴ | Profile Transition Range | Example RxMER Range (dB) Non-AWGN * | Example Profile Transition Range (With Margin) ** |
|-------|---|--------------------------|-------------------------------------|---|
| 256 | 24.1 | 25.6 ± 1.5 dB | 26 - 29 | 27.5 ± 1.5 dB |
| 512 | 27.1 | 28.6 ± 1.5 dB | 29 - 32 | 30.5 ± 1.5 dB |
| 1024 | 30.1 | 31.6 ± 1.5 dB | 32 - 35 | 33.5 ± 1.5 dB |
| 2048 | 33.1 | 34.6 ± 1.5 dB | 35 - 38 | 36.5 ± 1.5 dB |
| 4096 | 36.1 | 37.6 ± 1.5 dB | 38 - 41 | 39.5 ± 1.5 dB |
| 8192 | 39.1 | 40.6 ± 1.5 dB | 41 - 44 | 42.5 ± 1.5 dB |
| 16384 | 42.1 | 43.6 ± 1.5 dB | 44 - 47 | 45.5 ± 1.5 dB |

*Non-AWGN refers to non-ideal channels with impairments, higher margin for system variations, as well as fluctuations in the RxMER throughout the day/year from temperature/season and in particular random signal ingress of LTE and similar interference. These ranges are selected as an example only, to illustrate potential use of the D3.1 multiple profile capability. Many actual impairments may occur that require even higher ranges than shown for the modulation orders, especially noting that the lower end of the shown ranges are below the [SCTE 220-1] CM requirements in AWGN. Examples of some non-ideal channel conditions are seen in Figure 22 through Figure 29.

**Profile Transition Range provides an illustrative example of a real-world estimation of the RxMER range supported by a particular modulation. Experience in actual practice, in individual plants and within each operator's systems, will lead to refinement of these ranges over time.

Table 12 - AWGN vs. Non-AWGN Profile PDF Fit

| Sigma | Observe Population | σ Range (± 1.57 dB) | AWGN | Non-AWGN |
|---------------------|--------------------|---------------------------------|---------------------|----------------------|
| | | | M-QAM Profile Fit** | M-QAM Profile Fit*** |
| +2 σ = 39.56 | ~2.27% | 37.99 – 41.13 | 4096 | 2048/4096 |
| + σ = 37.99 | ~15.86% | 36.42 – 39.56 | 4096 | 2048 |
| m = 36.42 | ~49.99% | 34.85 - 37.99 | 2048 | 1024 |
| - σ = 34.85 | ~ 84.12% | 33.28 – 34.92 | 2048 | 1024 |
| -2 σ = 33.28 | ~ 97.72% | 31.71 – 34.85 | 1024 | 512 |
| -3 σ = 31.71 | ~ 99.86% | 30.14 – 32.85 | 1024 | 512 |

⁴ In practice, one will not see 3 dB steps between adjacent modulation orders as shown in the table's second column. The requirements in the DOCSIS 3.1 PHY specification increase slightly more than 3 dB per adjacent modulation order in general, to allow for increasing implementation loss at higher density constellations. In theory, the step size will be closer to about 5.5 dB between successive square constellations (e.g., 256-QAM and 1024-QAM), and about 2.7 to 2.8 dB between adjacent square and non-square constellations (e.g., 256-QAM and 512-QAM). For more information, see the SCTE Cable-Tec Expo paper "Demystifying the DOCSIS 3.1 PHY" by Prodan et al, 2014.

In Table 12 each sigma (σ) represents the next modulation midpoint. Since $\sigma = 1.57$ in the example, and a particular modulation has a swing of +/- 1.5 dB, this provides a close estimation to illustrate profile fitting.

** M-QAM selection relies on the lower bound RxMER sigma range

*** M-QAM selection relies on sigma

Table 13 - AWGN vs. Non-AWGN Profile Allocation per PDF in the Example

| Profile Support by CM | M-QAM (AWGN) | M-QAM (Non-AWGN) |
|-----------------------|--------------|------------------|
| A - 512-QAM | 100% | ~99.86% |
| B - 1024-QAM | ~99.86% | ~84.13% |
| C - 2048-QAM | ~84.13% | ~15.86% |
| D - 4096-QAM | ~15.86% | ~2.27% |

B.1.3. Conclusion

For a given DS service group CM population:

- The higher the mean or average of RxMER, the higher the modulation that can be supported.
- The smaller the overall standard deviation of the average RxMER for a population of modems within a service group, the fewer profiles are needed to support that service group.
- A larger overall standard deviation of the RxMER in the population may suggest an increase of profiles within a service group.

Depending on the spread and the mean, and starting with Profile-A at the highest percentage of coverage, the results do not automatically suggest that it should be at 256-QAM.

Appendix C.

C.1. PNM OFDM DS Receive Modulation Error Ratio

C.1.1. PNM Data Retrieval Call Flow

The following is an example of a general interaction between the PNM server and cable modem for test set operation and the PNM file retrieval process is the same process used in the evaluation.

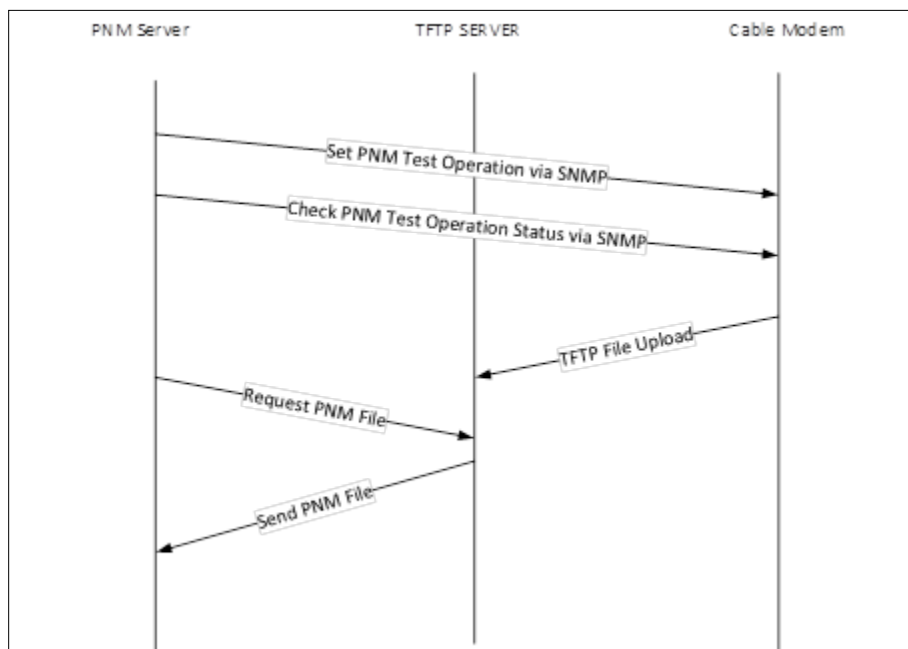

Figure 19 - PNM Server Process Example [SCTE 220-3]

C.1.2. RxMER Theory of Operation

DOCSIS 3.1 PNM provides measurements of the RxMER for each subcarrier, thereby allowing much more granular characterization of overall channel condition vs. frequency. The CM measures the RxMER using both continuous and scattered pilots and PLC preamble symbols, which are not as likely subject to symbol errors as data subcarriers would be. Each data subcarrier becomes a scattered pilot every 128 symbol periods. Therefore, at a minimum, it would take 128 symbol periods to get all RxMER values.

The OFDM receiver’s processing is similar to the SC-QAM receiver processing in many respects. The demodulator must first estimate and remove the frequency offset between the transmitting modulator and receiver’s tuner. Likewise, a symbol timing clock offset must be determined, and compensation made. Finally, the phase and amplitude variations of the channel impulse response must be removed through equalization [SCTE 220-1].

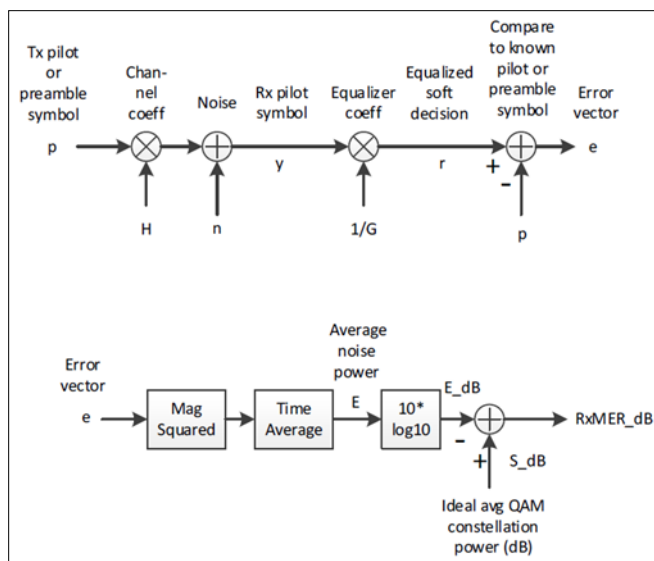

Figure 20 - RxMER DOCSIS Implementation Process [SCTE 220-1]

The amount of error between the ideal (hard) received symbol and received (soft) symbol, the error vector, is sampled and averaged to compute an RMS error vector magnitude (EVM), from which the RxMER is determined.

The error vector in Figure 21 is the difference between the equalized pilot and PLC preamble received value (soft decision) and the known correct pilot value or preamble value (hard decision).[SCTE 220-1]

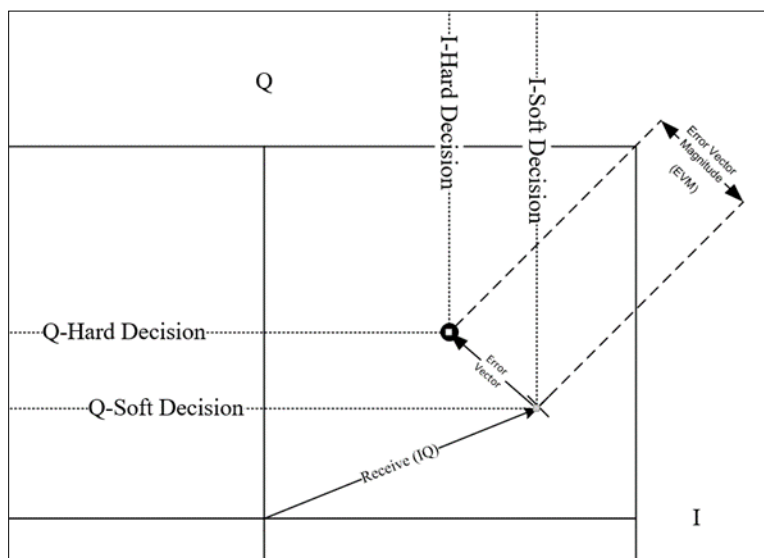

Figure 21 - Error Vector Diagram

The error vector is another transformation of the difference between the hard and soft symbol decisions. In the appendix section A.1.2, SNR vs. explains further the general determination of calculating RxMER without knowing the vector phase and amplitude error.

The RxMER is calculated per the as described in the DOCSIS 3.1 PHY specification [SCTE 220-1].

$$RxMER_{dB} = 10 * \text{Log}_{10}(EVM)$$

C.1.3. RxMER Analysis

In DOCSIS 3.1 OFDM, RxMER is generally equivalent to SNR. In the example used in this paper, the PNM MIB provides the RxMER magnitude in dB versus subcarrier frequency which can be graphed by the user. Variations in RxMER may be due to a variety of impairments. In displaying the RxMER, the user can observe many ingress or network impairments. The following figures are captured samples from a DOCSIS 3.1 field trial conducted by a major cable operator.

A search criterion was used to identify CMs with a standard deviation greater than 1 with a skewness value less than -1 to detect sharp ingress.

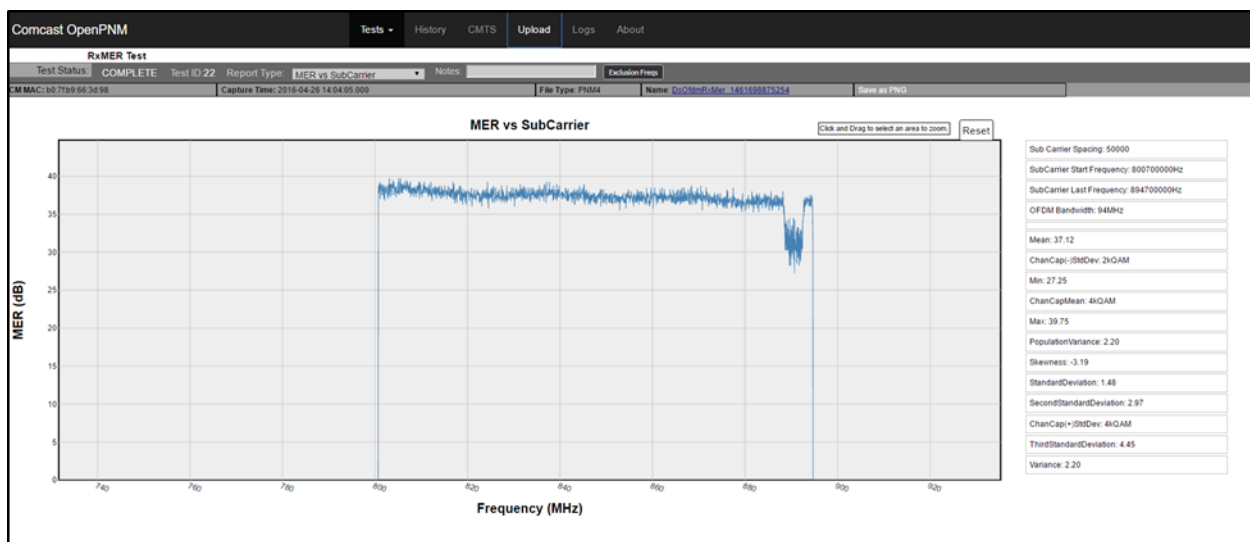

Figure 22 - RxMER Response - Signal Ingress

Note that Figure 22 was obtained remotely from field data, which shows the power of the centralized monitoring provided by PNM technology. It is unknown how the signal ingress was introduced, but one can see the statistics displayed in the table of the right side of Figure 9 by using the standard deviation and skewness as key performance indicators (KPIs). Using automation, CMs can be quickly screened for a potential problem.

Captures in Figure 22 and Figure 29 show RxMER responses that have RxMER distributions with skew less than -1, and appear to be impacted by ingress. Captures in Figure 25 and Figure 27 show RxMER responses that have RxMER distributions with skew greater than -1 which have impairment, presumed to be micro-reflections, but do not appear to be impacted by ingress. The RxMER distributions for those four RxMER responses are shown in Figure 23, Figure 26, Figure 28, and Figure 30.

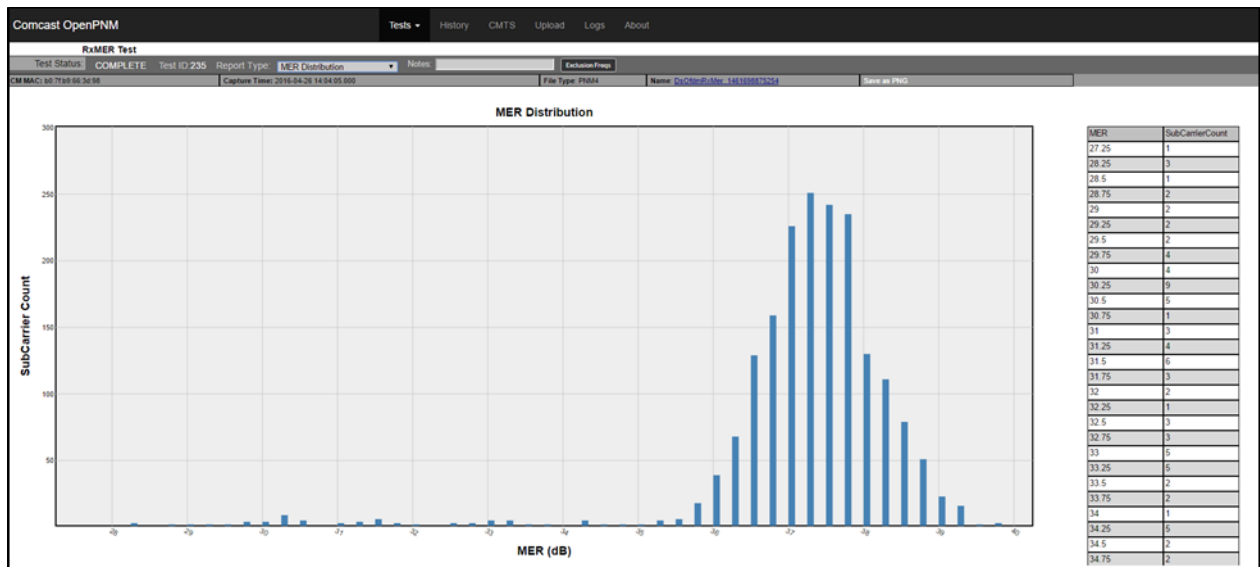

Figure 23 - RxMER Distribution indicating Skewness – Skewness of -3.19

Figure 23 shows the distribution of the subcarrier count per RxMER value. The skewness is observed as a shift of the RxMER counts to the right. Further examples of RxMER distributions with skewness (i.e., skewness less than -1) vs. non-skewness (i.e., skewness greater than -1) are shown in Figure 26, Figure 28, and Figure 30.

For completeness, Figure 24 illustrates a typical AWGN RxMER distribution for comparison.

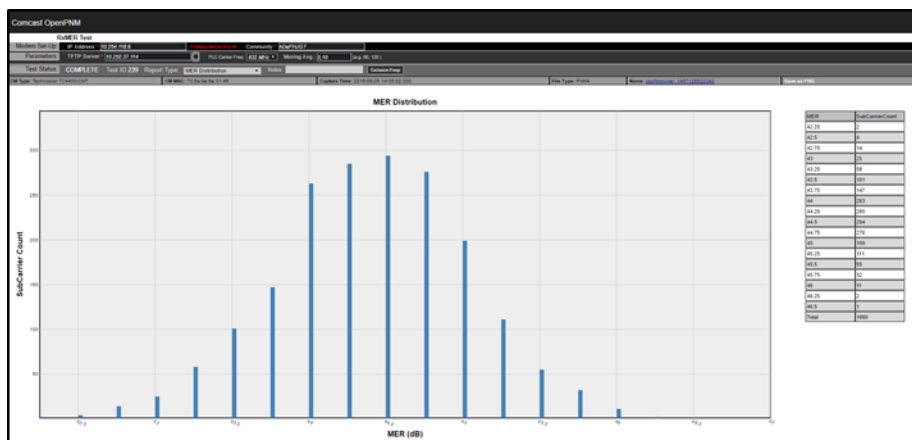

Figure 24 - RxMER Distribution of an AWGN Channel

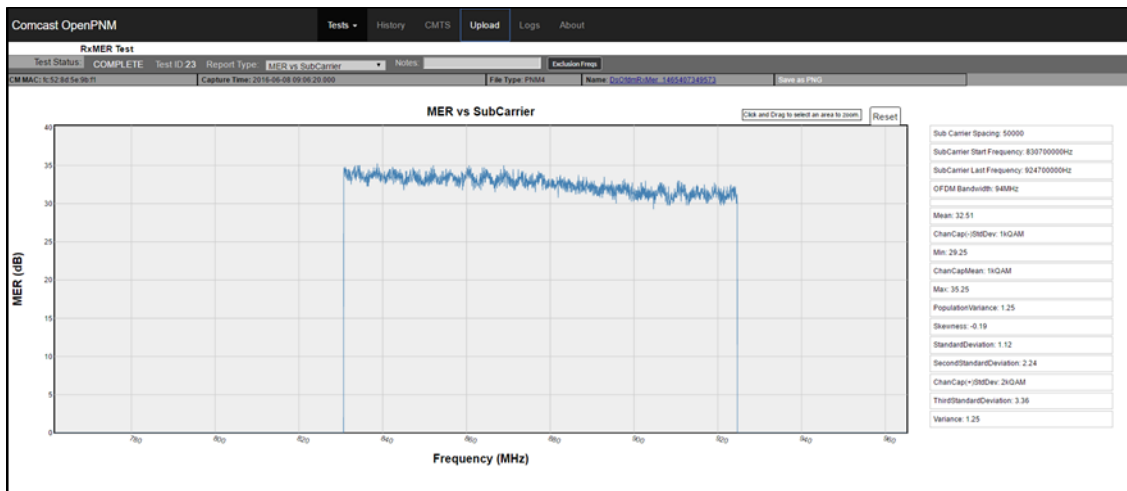

Figure 25 - RxMER Response – Micro-Reflection

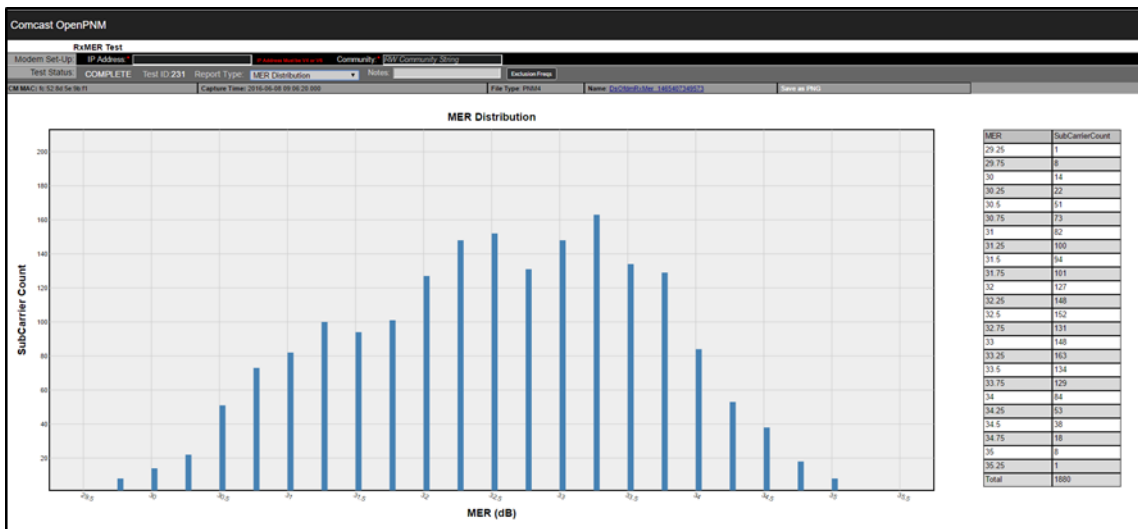

Figure 26 - RxMER Subcarrier Distribution - Micro-Reflection - Skewness of -0.19

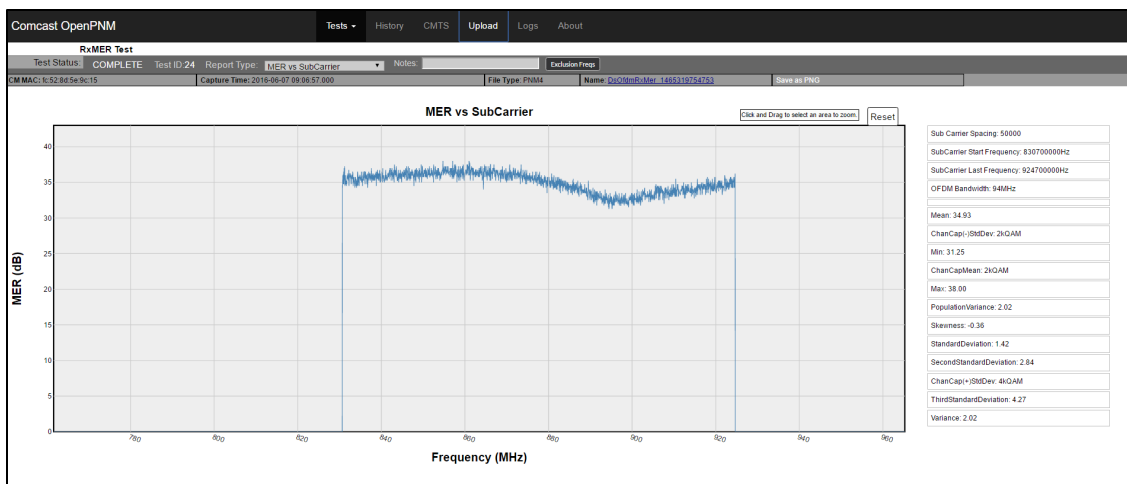

Figure 27 - RxMER Response – Micro-Reflection

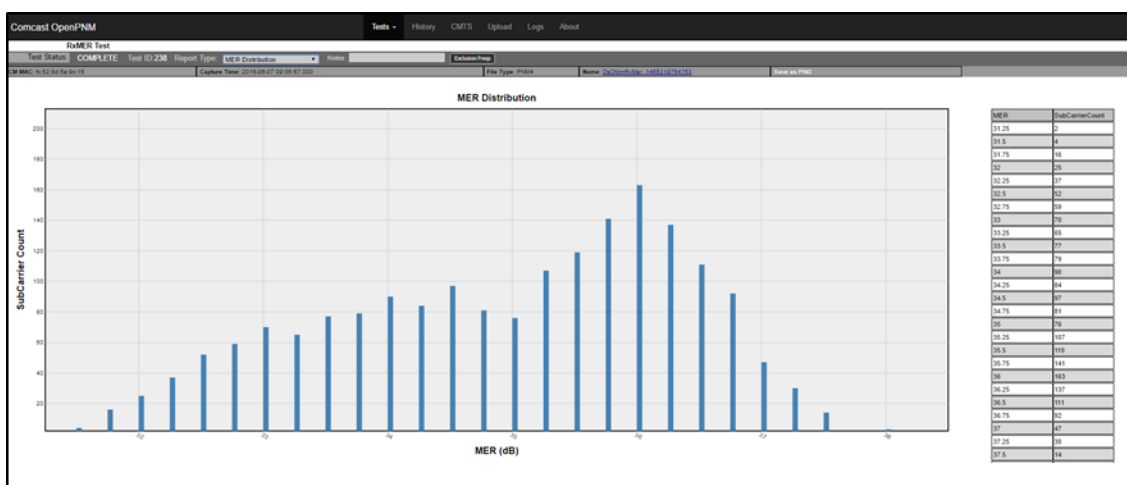

Figure 28 - RxMER Distribution – Micro-Reflection - Skewness of -0.36

Figure 25 and Figure 27 are captured from a DOCSIS 3.1 field trial and indicate wide-spaced amplitude ripple. Both are showing a skewness of greater than -1, and severity of RxMER response spread as indicated by a standard deviation of greater than 1 dB. Generally speaking, the standard deviation should be less than 2 dB, but 1 dB or less is even better.

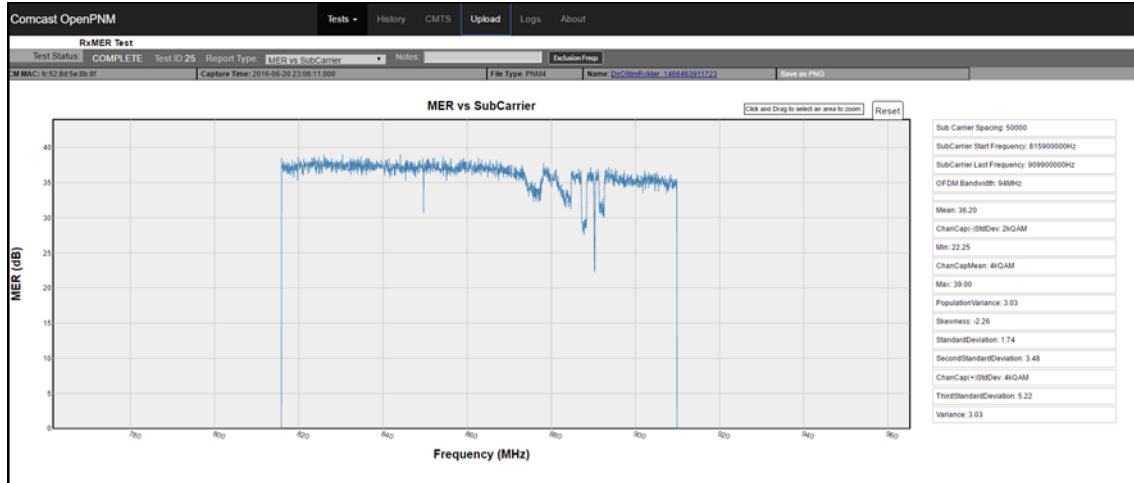

Figure 29 - Multiple Signal Ingress

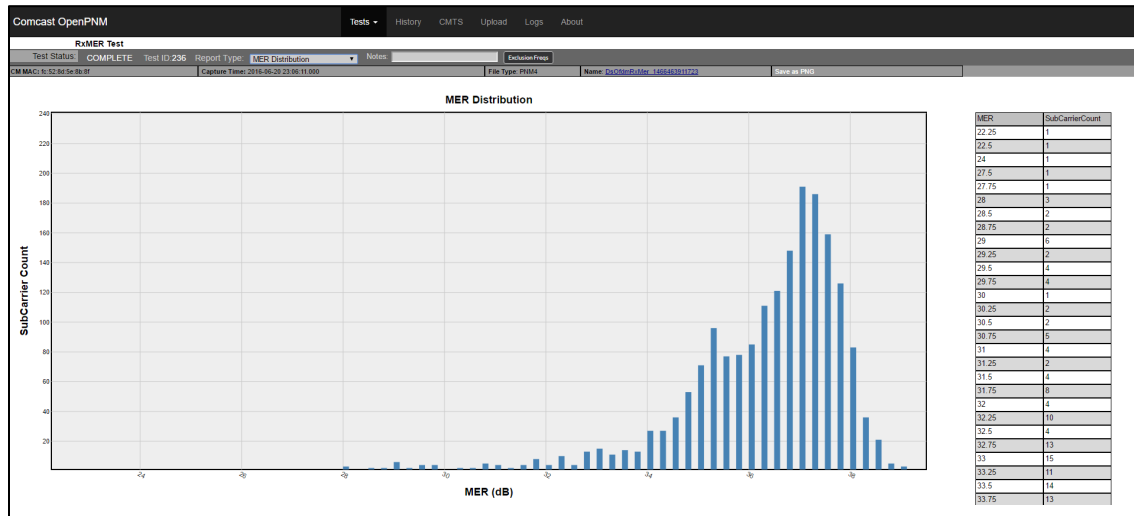

Figure 30 - RxMER Distribution - Skewness of -2.26