

SCTE | **STANDARDS**

Data Standards Subcommittee

AMERICAN NATIONAL STANDARD

ANSI/SCTE 137-5 2017 (R2021)

**Modular Headend Architecture Part 5: Edge QAM
Provisioning and Management Interface**

NOTICE

The Society of Cable Telecommunications Engineers (SCTE) Standards and Operational Practices (hereafter called “documents”) are intended to serve the public interest by providing specifications, test methods and procedures that promote uniformity of product, interoperability, interchangeability, best practices, and the long term reliability of broadband communications facilities. These documents shall not in any way preclude any member or non-member of SCTE from manufacturing or selling products not conforming to such documents, nor shall the existence of such standards preclude their voluntary use by those other than SCTE members.

SCTE assumes no obligations or liability whatsoever to any party who may adopt the documents. Such adopting party assumes all risks associated with adoption of these documents and accepts full responsibility for any damage and/or claims arising from the adoption of such documents.

NOTE: The user’s attention is called to the possibility that compliance with this document may require the use of an invention covered by patent rights. By publication of this document, no position is taken with respect to the validity of any such claim(s) or of any patent rights in connection therewith. If a patent holder has filed a statement of willingness to grant a license under these rights on reasonable and nondiscriminatory terms and conditions to applicants desiring to obtain such a license, then details may be obtained from the standards developer. SCTE shall not be responsible for identifying patents for which a license may be required or for conducting inquiries into the legal validity or scope of those patents that are brought to its attention.

Patent holders who believe that they hold patents which are essential to the implementation of this document have been requested to provide information about those patents and any related licensing terms and conditions. Any such declarations made before or after publication of this document are available on the SCTE web site at <https://scte.org>.

All Rights Reserved
©2021 Society of Cable Telecommunications Engineers, Inc.
140 Philips Road
Exton, PA 19341

Note: DOCSIS® is a registered trademark of Cable Television Laboratories, Inc., and is used in this document with permission.

Document Types and Tags

Document Type: Specification

Document Tags:

- | | | |
|---|------------------------------------|--|
| <input type="checkbox"/> Test or Measurement | <input type="checkbox"/> Checklist | <input type="checkbox"/> Facility |
| X Architecture or Framework | <input type="checkbox"/> Metric | X Access Network |
| <input type="checkbox"/> Procedure, Process or Method | <input type="checkbox"/> Cloud | <input type="checkbox"/> Customer Premises |

Document Release History

Release	Date
SCTE 137-5 2007	9/18/2007
SCTE 137-5 2010	11/2/2010
SCTE 137-5 2017	2/13/2017

Note: This document is a reaffirmation of SCTE 137-5 2017. No substantive changes have been made to this document. Information components may have been updated such as the title page, NOTICE text, headers, and footers.

Contents

1	SCOPE	1
1.1	Introduction and Purpose.....	1
1.2	Requirements and Conventions.....	1
2	REFERENCES	2
2.1	Normative References.....	2
2.2	Informative References.....	3
2.3	Reference Acquisition.....	3
3	TERMS AND DEFINITIONS	4
4	ABBREVIATIONS AND ACRONYMS	5
5	THEORY OF OPERATION	6
5.1	Introduction.....	6
5.2	Provisioning.....	6
5.3	Configuration.....	6
6	EQAM PROVISIONING	7
6.1	Establishing IP Connectivity.....	7
6.1.1	<i>EQAM Static Provisioning</i>	8
6.1.2	<i>EQAM Dynamic Provisioning</i>	8
6.1.2.1	Establish IPv4 Network Connectivity using DHCPv4.....	8
	TABLE 6-1 - DHCP BACKOFF DISTRIBUTION VALUES	9
7	EQAM CONFIGURATION	11
7.1	Configuration File Download.....	11
7.2	Initial EQAM Configuration.....	13
7.3	EQAM Configuration with Administrative Interface.....	13
7.4	EQAM Configuration with XML File.....	14
7.5	Vendor-Specific Extensions.....	14
7.6	XML Configuration File Checksum.....	15
7.7	Configuration Error File.....	15
8	EQAM MANAGEMENT	16
8.1	DOCSIS MIB Modules.....	16
	TABLE 8-1 - DOCSIS MIB MODULES	16
8.2	IETF RFC MIB Modules.....	16
	TABLE 8-2 - IETF RFC MIB MODULES	16
8.3	SCTE MIB Modules.....	18
	TABLE 8-3 - SCTE MIB MODULES	18
9	EQAM FAULT REPORTING	19
9.1	SNMP Usage.....	19
9.2	Event Notification.....	19
9.2.1	<i>Format of Events</i>	19
9.2.1.1	Local Event Logging.....	19
9.2.1.2	SNMP Notifications.....	20

9.2.1.3	Syslog message format.....	20
9.2.2	<i>BIT Values for docsDevEvReporting [RFC 4639]</i>	21
9.2.3	<i>Standard events for EQAM</i>	21
TABLE 9-1 - DEFAULT EVENT REPORTING MECHANISM VERSUS PRIORITY (NON-VOLATILE LOCAL LOG SUPPORT ONLY)		22
TABLE 9-2 - DEFAULT EVENT REPORTING MECHANISM VERSUS PRIORITY (VOLATILE LOCAL LOG SUPPORT ONLY)		22
TABLE 9-3 - DEFAULT EVENT REPORTING MECHANISM VERSUS PRIORITY		23
9.2.4	<i>Event Priorities and Vendor-Specific Events</i>	23
TABLE 9-4 - EVENT PRIORITIES ASSIGNMENT		23
9.3	List of events	23
ANNEX A DETAILED MIB REQUIREMENTS (NORMATIVE)		26
TABLE A-1 - MIB IMPLEMENTATION SUPPORT		26
TABLE A-2 - SNMP ACCESS REQUIREMENTS		26
A.1	Object Model schema Definition.....	27
TABLE A-3 - REQUIREMENTS		27
A.2	IF-MIB ifTable MIB-Object details.....	56
TABLE A-4 - IF-MIB IFTABLE MIB-OBJECT DETAILS		56
ANNEX B DESCRIPTION OF THE XML BASED CONFIGURATION FILE		58
B.1	EqamCfg.....	60
TABLE B-1 - EQAMCFG CONFIG FILE ELEMENTS		60
B.1.1	<i>System</i>	61
TABLE B-2 - SYSTEM OBJECT		61
B.1.2	<i>Inputs</i>	61
TABLE B-3 - INPUTS ELEMENTS		61
TABLE B-4 - EDGEINPUTS ELEMENTS		61
B.1.3	<i>RFOutputs</i>	61
TABLE B-5 - RFOUTPUTS ELEMENTS		61
TABLE B-6 - RFPORPTS ELEMENTS		62
TABLE B-7 - RFPORPT ELEMENTS		62
TABLE B-8 - QAMCHANNELS ELEMENTS		62
TABLE B-9 - CHANNEL ELEMENTS		62
B.1.4	<i>Vendor Object</i>	62
TABLE B-10 - VENDOR OBJECT		62
B.1.5	<i>Checksum Object</i>	63

TABLE B-11 - CHECKSUM OBJECT	63
B.2 Configuration File XML Schema Definition	63
B.2.1 <i>EQAM-CFG_1.0.XSD</i>	63
B.2.2 <i>EQAM_1.0.XSD</i>	64
B.2.3 <i>DOCS-CABLE-DEVICE_RFC4639.XSD</i>	69
B.2.4 <i>SNMPv2_RFC3418.XSD</i>	69
ANNEX C DOCS-EQAM MANAGEMENT REQUIREMENTS.....	71
C.1 DOCS-EQAM Object Model Overview	71
C.2 DOCS-EQAM Object Model Definitions.....	71
C.2.1 <i>DOCS-EQAM Object Model Data Types</i>	71
C.2.2 <i>DOCS-EQAM Object Model Class Diagram</i>	72
C.2.3 <i>DOCS-EQAM Object Model Description</i>	73
TABLE C-1 - CONTROL OBJECT	73
TABLE C-2 - NMSACCESS OBJECT	74
TABLE C-3 - TIME OBJECT	75
TABLE C-4 - SYSLOGSERVER OBJECT	76
TABLE C-5 - REGISTRATION OBJECT	76
TABLE C-6 - TSINPUTCFG OBJECT	78
TABLE C-7 - TSOUTPUTCFG OBJECT.....	79
TABLE C-8 - RESERVEDUDPMAP OBJECT.....	79
TABLE C-9 - RESERVEDPIDRANGE OBJECT.....	79
TABLE C-10 - DEPICFG OBJECT.....	80
TABLE C-11 - EDGEINPUT OBJECT	80
TABLE C-12 - INPUTREGISTRATION	81
TABLE C-13 - RFPORT OBJECT	81
TABLE C-14 - FIBERNODE OBJECT	83
TABLE C-15 - CHANNEL OBJECT.....	83
TABLE C-16 - TSOUTPUT OBJECT	85
TABLE C-17 - STATICUDPMAP OBJECT.....	86
TABLE C-18 - SESSIONLOGCTRL.....	86
TABLE C-19 - SESSIONLOG.....	87
TABLE C-20 - NOTIFY OBJECT	89
C.3 EQAM MIB Module.....	89

Figures

FIGURE 6-1 - EQAM PROVISIONING FLOW	7
FIGURE 6-2 - IPV4 PROVISIONING MESSAGE FLOW	8
FIGURE 7-1 - EQAM CONFIGURATION PROCESS	12
FIGURE B-1 - XML CONFIGURATION OBJECT MODEL	59
FIGURE C-1 - QAM OBJECT MODEL DIAGRAM.....	72

Tables

TABLE 6–1 - DHCP BACKOFF DISTRIBUTION VALUES	9
TABLE 8–1 - DOCSIS MIB MODULES	16
TABLE 8–2 - IETF RFC MIB MODULES.....	16
TABLE 8–3 - SCTE MIB MODULES.....	18
TABLE 9–1 - DEFAULT EVENT REPORTING MECHANISM VERSUS PRIORITY (NON-VOLATILE LOCAL LOG SUPPORT ONLY)	22
TABLE 9–2 - DEFAULT EVENT REPORTING MECHANISM VERSUS PRIORITY (VOLATILE LOCAL LOG SUPPORT ONLY).....	22
TABLE 9–3 - DEFAULT EVENT REPORTING MECHANISM VERSUS PRIORITY	23
TABLE 9–4 - EVENT PRIORITIES ASSIGNMENT	23
TABLE A–1 - MIB IMPLEMENTATION SUPPORT	26
TABLE A–2 - SNMP ACCESS REQUIREMENTS	26
TABLE A–3 - REQUIREMENTS	27
TABLE A–4 - IF-MIB IFTABLE MIB-OBJECT DETAILS	56
TABLE B–1 - EQAMCFG CONFIG FILE ELEMENTS	60
TABLE B–2 - SYSTEM OBJECT	61
TABLE B–3 - INPUTS ELEMENTS	61
TABLE B–4 - EDGEINPUTS ELEMENTS	61
TABLE B–5 - RFOUTPUTS ELEMENTS.....	61
TABLE B–6 - RFPORTS ELEMENTS	62
TABLE B–7 - RFPORT ELEMENTS	62
TABLE B–8 - QAMCHANNELS ELEMENTS.....	62
TABLE B–9 - CHANNEL ELEMENTS.....	62
TABLE B–10 - VENDOR OBJECT	62
TABLE B–11 - CHECKSUM OBJECT.....	63
TABLE C–1 - CONTROL OBJECT	73
TABLE C–2 - NMSACCESS OBJECT.....	74
TABLE C–3 - TIME OBJECT	75
TABLE C–4 - SYSLOGSERVER OBJECT	76
TABLE C–5 - REGISTRATION OBJECT	76
TABLE C–6 - TSINPUTCFG OBJECT.....	78
TABLE C–7 - TSOUTPUTCFG OBJECT	79
TABLE C–8 - RESERVEDUDPMP OBJECT	79
TABLE C–9 - RESERVEDPIDRANGE OBJECT.....	79
TABLE C–10 - DEPICFG OBJECT	80
TABLE C–11 - EDGEINPUT OBJECT	80
TABLE C–12 - INPUTREGISTRATION.....	81
TABLE C–13 - RFPORT OBJECT	81
TABLE C–14 - FIBERNODE OBJECT	83
TABLE C–15 - CHANNEL OBJECT	83
TABLE C–16 - TSOUTPUT OBJECT	85
TABLE C–17 - STATICUDPMP OBJECT.....	86
TABLE C–18 - SESSIONLOGCTRL.....	86
TABLE C–19 - SESSIONLOG	87
TABLE C–20 - NOTIFY OBJECT.....	89

This page left blank intentionally.

1 SCOPE

NOTE: This document is identical to SCTE 137-5 2010 except for informative components which may have been updated such as the title page, NOTICE text, headers and footers. No normative changes have been made to this document.

1.1 Introduction and Purpose

This specification is a component of the Modular Headend Architecture; in particular it defines the Provisioning and Management requirements for the EQAM device.

1.2 Requirements and Conventions

Throughout this document, the words that are used to define the significance of particular requirements are capitalized. These words are:

"MUST"	This word means that the item is an absolute requirement of this specification.
"MUST NOT"	This phrase means that the item is an absolute prohibition of this specification.
"SHOULD"	This word means that there may exist valid reasons in particular circumstances to ignore this item, but the full implications should be understood and the case carefully weighed before choosing a different course.
"SHOULD NOT"	This phrase means that there may exist valid reasons in particular circumstances when the listed behavior is acceptable or even useful, but the full implications should be understood and the case carefully weighed before implementing any behavior described with this label.
"MAY"	This word means that this item is truly optional. One vendor may choose to include the item because a particular marketplace requires it or because it enhances the product, for example; another vendor may omit the same item.

2 REFERENCES

2.1 Normative References

The following documents contain provisions, which, through reference in this text, constitute provisions of this standard. At the time of publication, the editions indicated were valid. All standards are subject to revision, and users of this document are encouraged to investigate the possibility of applying the most recent editions of the documents listed below.

- [CANN DHCP] CableLabs DHCP Options Registry Specification, CL-SP-CANN-DHCP-Reg-I03-090811, August 11, 2009, Cable Television Laboratories, Inc.
- [PW-MIB] IETF draft-ietf-pwe3-pw-mib-14.txt, Zelig, D., Nadeau, T., Pseudo Wire (PW) Management Information Base, January 2008, <http://tools.ietf.org/html/draft-ietf-pwe3-pw-mib-14>.
- [RFC 1123] IETF RFC 1123/STD0003, R. Braden, Editor, Requirements for Internet Hosts -- Application and Support, October 1989.
- [RFC 1350] IETF RFC 1350/STD0033, K. Sollins, The TFTP Protocol (Revision 2), July 1992.
- [RFC 2011] IETF RFC 2011, Category: Standards Track SNMPv2 Management Information Base for the Internet Protocol using SMIV2, November 1996.
- [RFC 2131] IETF RFC 2131, R. Droms, Dynamic Host Configuration Protocol, March 1997.
- [RFC 2326] IETF RFC 2326, H. Schulzrinne, Columbia U., R. Lanphier, Real Time Streaming Protocol (RTSP), April 1998.
- [RFC 2348] IETF RFC 2348, G. Malkin, A. Harkin, TFTP Blocksize Option, May 1998.
- [RFC 2661] IETF RFC 2661, Layer Two Tunneling Protocol "L2TP", August 1999.
- [RFC 2863] IETF RFC 2853, The Interfaces Group MIB, June 2000.
- [RFC 3164] IETF RFC 3164, C. Lonvick, The BSD syslog Protocol, August 2001.
- [RFC 3203] IETF RFC 3203, Y. T'Joens, C. Hublet, P. DeSchrijver, DHCP reconfigure extension, December 2001.
- [RFC 3371] IETF RFC 3371, L2TPv3 Extensions Working Group, Layer Two Tunneling Protocol 'L2TP' Management Information Base, August 2002.
- [RFC 3411] IETF RFC 3411/STD0062, An Architecture for Describing Simple Network Management Protocol (SNMP) Management Frameworks, December 2002.
- [RFC 3412] IETF RFC 341 /STD0062, Message Processing and Dispatching for the Simple Network Management Protocol (SNMP), December 2002.
- [RFC 3413] IETF RFC 3413/STD0062, Simple Network Management Protocol (SNMP) Applications, December 2002.
- [RFC 3414] IETF RFC 3414/STD0062, User-based Security Model (USM) for version 3 of the Simple Network Management Protocol (SNMPv3), December 2002.
- [RFC 3415] IETF RFC 3415/STD0062, View-based Access Control Model (VACM) for the Simple Network Management Protocol (SNMP), December 2002.
- [RFC 3418] IETF RFC 3418/STD0062, Management Information Base (MIB) for the Simple Network Management Protocol (SNMP), December 2002.
- [RFC 3584] IETF RFC 3584, Coexistence between Version 1, Version 2, and Version 3 of the Internet-standard Network Management Framework, August 2003.
- [RFC 4087] IETF RFC 4087, D. Thaler, IP Tunnel MIB, June 2005.
- [RFC 4133] IETF RFC 4133, A. Bierman, K. and McCloghrie, Entity MIB, August 2005.
- [RFC 4291] IETF RFC 4291, R. Hinden, S. Deering, IP Version 6 Addressing Architecture, February 2006.

- [RFC 4293] IETF RFC 4293, S. Routhier, Ed., Management Information Base for the Internet Protocol (IP), April 2006.
- [RFC 4361] IETF RFC 4361, T. Lemon and B. Sommerfield, Node-specific Client Identifiers for Dynamic Host Configuration Protocol Version Four (DHCPv4), February 2006.
- [RFC 4546] IETF RFC 4546, D. Raftus and E. Cardona, Radio Frequency (RF) Interface Management Information Base for DOCSIS 2.0 Compliant RF Interfaces, June 2006.
- [RFC 4639] IETF RFC 4639, R. Woundy and K. Marez, Cable Device Management Information Base for Data-Over-Cable Service Interface Specification (DOCSIS) Compliant Cable Modems and Cable Modem Termination Systems, December 2006.
- [SCTE 137-3] ANSI/SCTE 137-3 2007, Modular Headend Architecture Part 3: Operations Support System Interface. (Formerly known as SCTE 141.)
- [SCTE 137-4] ANSI/SCTE 137-4 2007, Modular Headend Architecture Part 4: Edge Resource Manager Interface. (Formerly known as SCTE 139.)
- [SCTE 154-2] ANSI/SCTE 154-2 2008, SCTE-HMS-QAM-MIB Management Information Base (MIB) Definition.
- [SCTE 154-4] ANSI/SCTE 154-4 2008, MPEG Management Information Base.
- [SHA-1] Federal Information Processing Standards Publication 180-2, 2002 August 1, Announcing the Secure Hash Standard.

2.2 Informative References

- [SCTE 137-7] SCTE 137-7 2010, Modular Headend Architecture Part 7: EQAM Architectural Overview Technical Report

2.3 Reference Acquisition

- Cable Television Laboratories, Inc., 858 Coal Creek Circle, Louisville, CO 80027; Phone +1-303-661-9100; Fax +1-303-661-9199; <http://www.cablelabs.com>
- International Telecommunication Union – Telecommunication Standardization Sector (ITU-T), <http://www.itu.int/itu-t/>
- Federal Information Processing Standards (FIPS-PUBS); <http://www.itl.nist.gov/fipspubs/by-num.htm>
- Society of Cable Telecommunication Engineers, 140 Philips Road, Exton PA 19341-1318, Phone +1-610-524-1725; Internet: <http://www.scte.org> / E-Mail: standards@scte.org

3 TERMS AND DEFINITIONS

This specification uses the following terms:

- Edge QAM** A head-end or hub device that receives packets of digital video or data from the operator network. It re-packetizes the video or data into an MPEG transport stream and digitally modulates the transport stream onto a downstream RF carrier using QAM.
- MAC domain** A grouping of layer 2 devices that can communicate with each other without using bridging or routing. In DOCSIS, a MAC domain is the group of CMs that are using upstream and downstream channels linked together through a MAC forwarding entity.
- Service Group** An HFC service group (also known as a service group) is a portion of an HFC access network used to deliver a set of services to a population of cable modems that share a common spectrum of RF channels.

4 ABBREVIATIONS AND ACRONYMS

This specification uses the following abbreviations:

EQAM	Edge QAM
ERM	Edge Resource Manager
HFC	Hybrid Fiber/Coaxial Cable
IF	Interface
IEEE	Institute of Electrical and Electronics Engineers
IGMP	Internet Group Management Protocol
IP	Internet Protocol
MPEG	Moving Pictures Experts Group
MPTS	Multiple Program Transport Stream
NMS	Network Management System
QAM	Quadrature Amplitude Modulator
RF	Radio Frequency
RFC	Request for Comment
SDV	Switched Digital Video
SPTS	Single Program Transport Stream
SSM	Source Specific Multicast
XML	Extensible Markup Language
XSID	XML Schema Definition

5 THEORY OF OPERATION

The role of the EQAM in the video-on-demand and switched-digital-video architecture is to receive an IP unicast or multicast stream containing MPEG transport stream packets, and then produce that transport stream on one or more RF outputs for transmission over the hybrid fiber-coax cable plant.

5.1 Introduction

This specification covers the configuration, provisioning, and management requirements for an EQAM device. The Provisioning section provides details on how the EQAM is initially provisioned manually, as well as via DHCP-based provisioning. The Configuration section provides details on how the configuration management settings are applied and saved at the EQAM. The Fault Management section provides details on error-handling requirements for the EQAM. Finally, the Management requirements are covered in the Annex sections of this specification.

5.2 Provisioning

The EQAM management interface needs to be provisioned with an IP address and other configuration parameters. The EQAM IPv4 provisioning is specified to allow Operators flexibility with either static or dynamic using DHCPv4 provisioning process.

5.3 Configuration

The XML configuration file is used to set the EQAM parameters value. The configuration file must always be fully reapplied at boot up time. At any time, the EQAM must be able to apply the common section of the XML configuration described in this specification. The configuration file can be saved locally on the EQAM (with non-volatile memory) or remotely on a centralized file server.

When the configuration files are on a server, they can be downloaded to the EQAM with TFTP or HTTPS via manual or DHCP control. The file can also be uploaded to the server to keep an updated copy when the EQAM configuration is modified by other administrative interfaces (CLI/GUI/SNMP). To keep some flexibility, specific vendor extensions can be included in a dedicated section of the file.

6 EQAM PROVISIONING

6.1 Establishing IP Connectivity

The EQAM's Management interface requires an IP address and other parameters before it can download its initial configuration file. Static as well as dynamic (DHCP) provisioning will be available to provision the IP parameters for the EQAM Management interface. The EQAM provisioning flow is outlined in Figure 6–1.

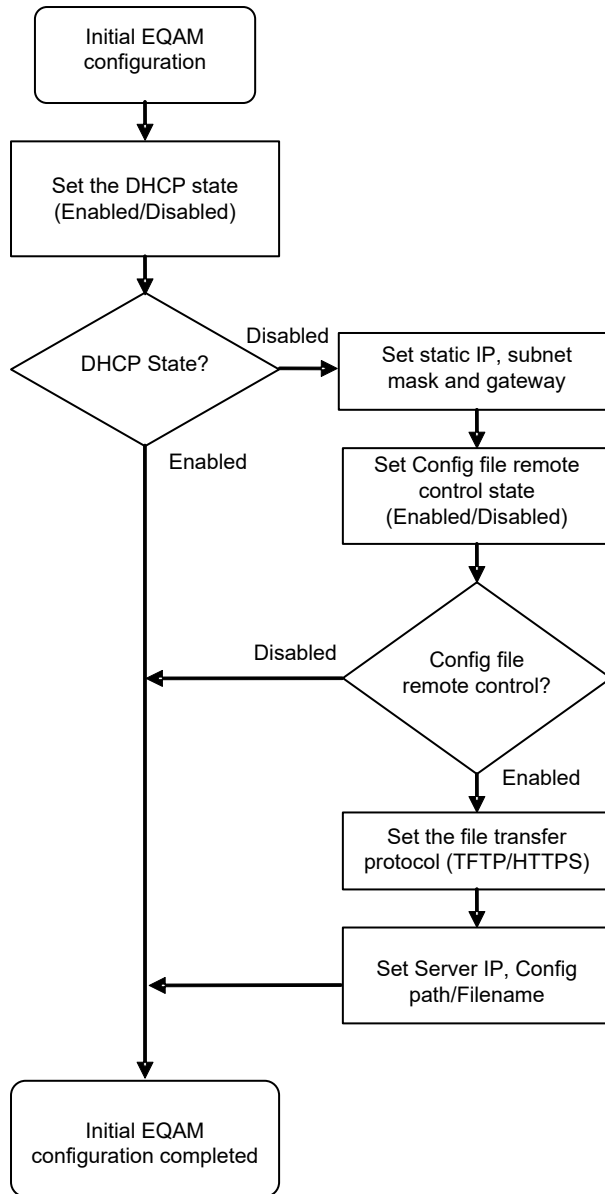

Figure 6–1 - EQAM Provisioning Flow

6.1.1 EQAM Static Provisioning

The EQAM MUST provide a user interface for provisioning the IP address, the IP mask, the default router address, the TFTP server address, and the configuration file name for its Management interface.

When shipped, the EQAM MUST be able to perform a standalone boot with the following factory configuration:

- Known static IP address (192.168.0.1)
- RF ports disabled

6.1.2 EQAM Dynamic Provisioning

The EQAM MUST allow the selection of DHCP for provisioning of its Management Interface.

6.1.2.1 Establish IPv4 Network Connectivity using DHCPv4

This section describes how the EQAM is dynamically provisioned with an IPv4 address and associated parameters.

The standard DHCPv4 message exchange between the EQAM and the DHCPv4 server is shown in Figure 6–2. The EQAM MUST use DHCPv4 [RFC 2131] in order to obtain an IP address and other parameters needed to establish IP connectivity.

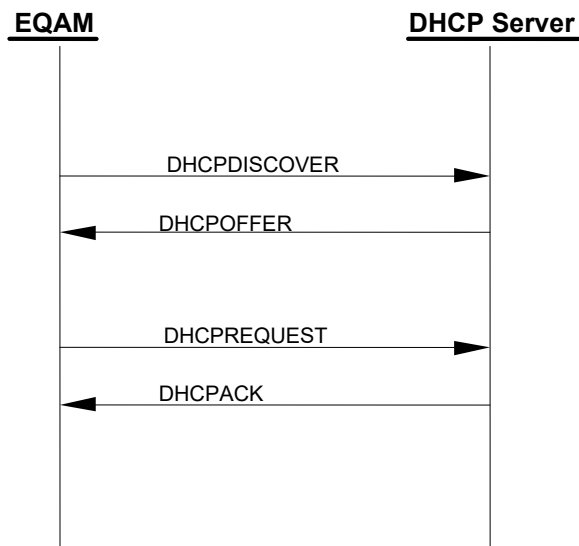

Figure 6–2 - IPv4 Provisioning Message Flow

The EQAM may receive multiple DHCPOFFER messages in response to its DHCPDISCOVER message. If a received DHCPOFFER message does not include all of the required DHCPv4 fields and options as described in Section 6.1.2.1.1, the EQAM MUST discard the DHCPOFFER message and wait for another DHCPOFFER message. If none of the received DHCPOFFER messages contain all the required DHCPv4 fields and options, the EQAM retransmits the DHCPDISCOVER message.

The EQAM SHOULD choose backoff values for retransmission of DHCPDISCOVER messages according to a uniform distribution between the minimum and maximum values in the rows of the table below.

Table 6-1 - DHCP Backoff Distribution Values

Backoff Number	Minimum (sec.)	Maximum (sec.)
1	3	5
2	7	9
3	15	17
4	31	33
5	63	65

The EQAM SHOULD also implement a different retransmission strategy for the RENEWING and REBINDING states as recommended in [RFC 2131], which is based on one-half of the remaining lease time.

The EQAM MUST limit the number of retransmissions to five or fewer for the DHCPDISCOVER and DHCPREQUEST messages.

[RFC 3203] describes an extension to DHCPv4 that allows a DHCP server to send a FORCERENEW message that forces a client to renew its lease. The EQAM MUST ignore all received FORCERENEW messages.

6.1.2.1.1 DHCPv4 Fields Used by the EQAM

The following fields MUST be present in the DHCPDISCOVER and DHCPREQUEST messages from the EQAM:

- The hardware type (htype) MUST be set to 1;
- The hardware length (hlen) MUST be set to 6;
- The client hardware address (chaddr) MUST be set to the 48-bit MAC address associated with the Management interface of the EQAM;
- The client identifier option MUST be included using the format defined in [RFC 4361];
- The parameter request list option MUST be included. The following option codes defined in [RFC 2131] MUST be included in the list:
 - Option code 1 (Subnet Mask)
 - Option code 2 (Time Offset)
 - Option code 3 (Router Option)
 - Option code 4 (Time Server Option)
 - Option code 7 (Log Server Option)
- Option code 60 (Vendor Class Identifier) - the following ASCII-encoded string MUST be present in Option code 60: "EQAM:"
- Option code 125 (DHCPv4 Vendor - Identifying Vendor Specific Information Options for DOCSIS 3.0 defined in [CANN DHCP] includes the following sub-options:
 - Sub-option code 1, the DHCPv4 Option Request option. This option code MUST be included in the DHCPv4 Option Request option.
 - Sub-option code 2, DHCPv4 TFTP Servers Option.

The following fields are expected in the DHCP OFFER and DHCP ACK messages returned to the EQAM. The EQAM MUST configure itself with the listed fields from the DHCP ACK:

- The IP address to be used by the EQAM (yiaddr) (critical);
- The IP addresses of the TFTP servers for use in the next phase of the boot process (DHCPv4 TFTP Servers option defined in [CANN DHCP]) (optional);
- The name of the EQAM configuration file to be read from the TFTP server by the EQAM (file) (optional);
- The subnet mask to be used by the EQAM (Subnet Mask, option 1) (non-critical);
- The time offset of the EQAM from UTC (Time Offset, option 2). This is used by the EQAM to calculate a time for use in error logs (non-critical).
- A list of addresses of one or more routers to be used for forwarding IP traffic originating from the EQAM's IP stack (Router Option, option 3). The EQAM is not required to use more than one router IP address for forwarding (non-critical).
- A list of ToD servers from which the current time may be obtained (Time Server Option, option 4) (non-critical).
- A list of syslog servers to which logging information may be sent (Log Server Option, option 7) (non-critical).

If a critical field is missing or invalid in the DHCP ACK received during initialization, the EQAM MUST:

1. Log an error.
2. Proceed as if the acquisition of the IPv4 address through DHCPv4 has failed.

If a non-critical field is missing or invalid in the DHCP ACK received during initialization, the EQAM MUST log a warning, ignore the field, and continue the IPv4 provisioning process.

If the yiaddr field is missing or invalid in the DHCP ACK received during a renew or rebind operation, the EQAM MUST log an error and restart DHCPv4 provisioning.

If any other critical or non-critical field is missing or invalid in the DHCP ACK received during a renew or rebind operation, the EQAM MUST log a warning, ignore the field if it is invalid, and remain operational.

6.1.2.1.2 Use of T1 and T2 Timers

The EQAM MUST initiate the lease renewal process when timer DHCP-T1 expires. The EQAM MUST initiate the lease rebinding process when timer DHCP-T2 expires. Timers DHCP-T1 and DHCP-T2 are called T1 and T2, respectively, in the DHCP specifications. If the DHCP server sends a value for DHCP-T1 to the EQAM in a DHCP message option, the EQAM MUST use that value. If the DHCP server does not send a value for DHCP-T1, the EQAM MUST set DHCP-T1 to one-half of the duration of the lease [RFC 2131]. If the DHCP server sends a value for DHCP-T2 to the EQAM in a DHCP message option, the EQAM MUST use that value. If the DHCP server does not send a value for DHCP-T2, the EQAM MUST set DHCP-T2 to seven-eighths of the duration of the [RFC 2131].

6.1.2.1.2.1 DHCPv4 Renew Fields Used by the EQAM

It is possible during the DHCPv4 renew operation that the EQAM will receive updated fields in the DHCP ACK message. If the EQAM is unable to use the updated values of those fields, it may discard the renew operation and restart DHCP.

7 EQAM CONFIGURATION

The EQAM either uses a locally stored configuration or tries to download a configuration file using TFTP from the File Server.

If the EQAM is statically provisioned with its IP Address information and the configuration file download information is also supplied, then it uses the configuration file download mechanism via TFTP as specified below. If the configuration file download information is left out during static provisioning, then the EQAM uses the locally stored configuration.

If the EQAM is dynamically provisioned via DHCPv4 for its IP Address information and the configuration file download information is also supplied through DHCPv4, then it uses the configuration file download mechanism via TFTP as specified below. If the configuration file download information is left out during DHCPv4 provisioning, then the EQAM uses the locally stored configuration.

Figure 7–1 shows the configuration process for the EQAM. The next section defines how an EQAM downloads its configuration file and uses the configuration parameters to initialize its resources.

7.1 Configuration File Download

The EQAM MUST use TFTP to obtain a configuration file from the server(s) identified in the DHCPv4 TFTP Servers option, when provided. The EQAM MUST include the TFTP Blocksize option [RFC 2348] when requesting the configuration file. The EQAM MUST request a blocksize of 1428 if using TFTP over IPv4.

There may be more than one value in the DHCPv4 TFTP Servers option in the DHCPACK; the EQAM MUST use the values in this option to obtain its configuration file.

The EQAM MUST use the following procedure to attempt configuration file download:

- Initiate a configuration file download by sending a TFTP read request message for the configuration file to the TFTP server, thus establishing a connection with the server [RFC 1350].
- If the EQAM is unable to download the configuration file on the first try successfully, the EQAM MUST retry the TFTP read request as defined below.
- The EQAM MUST use an adaptive timeout based on binary exponential backoff until the EQAM successfully receives the requested file from the server as follows:
 1. Each retry is 2^n second(s) following the previous request, where the EQAM configuration file retry counter, $n = \{0, 1, 2 \dots \text{MaxRetryCounter}-1\}$. The default MaxRetryCounter is 5.
 2. The retry counter $n = 0$ for the first retry, then is incremented by one for each subsequent request until $n = (\text{MaxRetryCounter}-1)$.
- If the EQAM does not successfully acquire the requested configuration file following the attempt with $n = (\text{MaxRetryCounter}-1)$, n is to be reset to 0 and the EQAM moves to next Server IP if present and repeats the above procedure.
- Once the EQAM reaches the end of the DHCPv4 TFTP Servers List, it increments the TFTP retry attempts count by one and repeats the above procedure for each Server IP until TFTP retry attempts count equals MaxRetryAttempt. By default, MaxRetryAttempt must be 3.

If WaitConfigFile value is FALSE (2) after completing the above procedure without successfully downloading a configuration file, the EQAM MUST utilize the locally stored configuration. By default, WaitConfigFile MUST be FALSE(2).

If WaitConfigFile is set to TRUE (1) after completing the above procedure without successfully downloading a configuration file, the EQAM MUST re-start the DHCP process from the beginning.

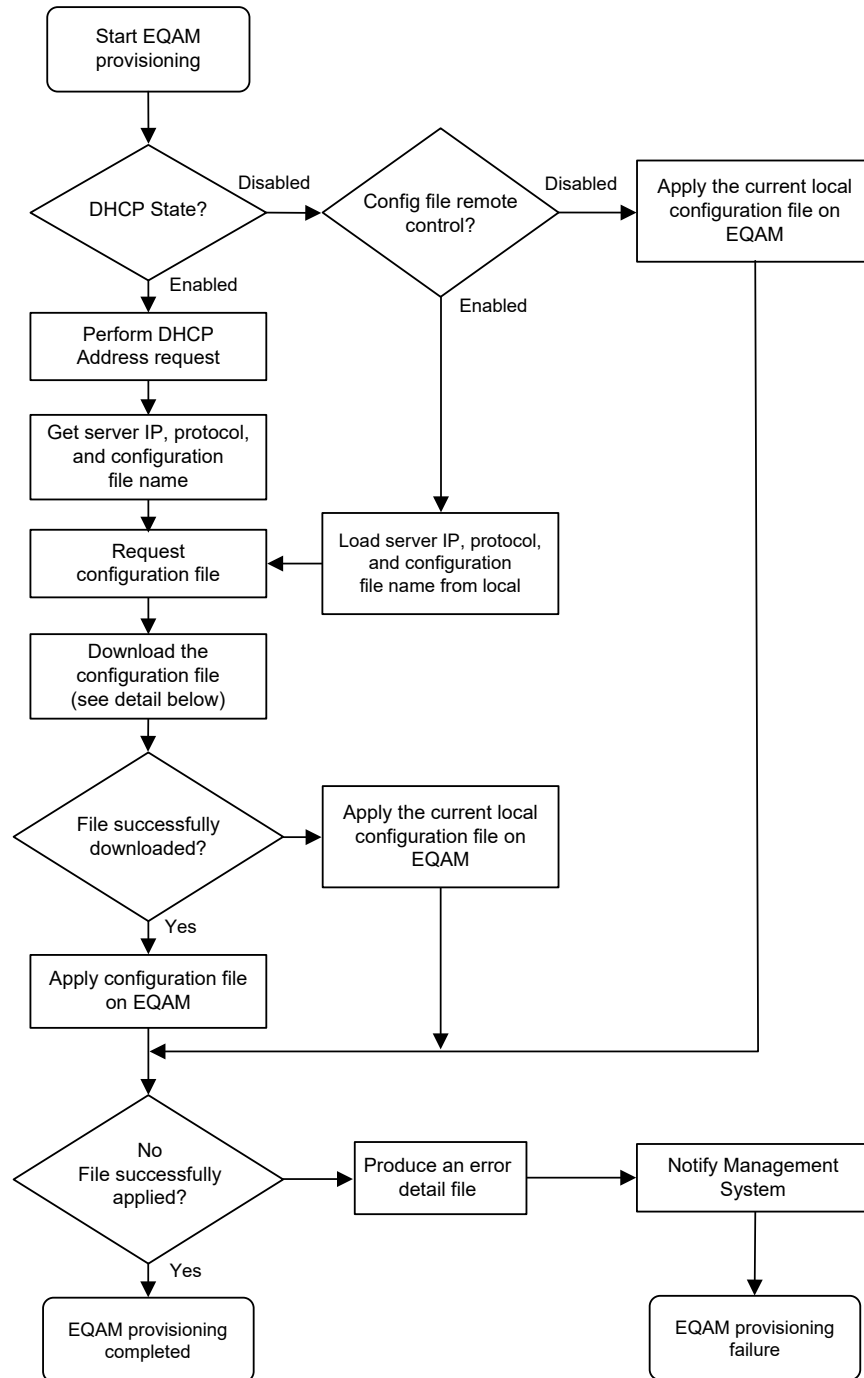

Figure 7-1 - EQAM Configuration Process

7.2 Initial EQAM Configuration

Once the EQAM IP configuration is done and the configuration file remote control is activated, an initial configuration file can be used to set up the EQAM with a known default state.

The initial configuration file contains some basic default configuration values for the individual headend/serving groups (based on the fact that not all headends/serving groups are configured the same) and different types of EQAM equipment (vendor differences, as well as model differences).

7.3 EQAM Configuration with Administrative Interface

Once the EQAM is operational, configuration settings on the EQAM can be modified via an administrative interface. The administrative interface includes a small set of standard SNMP RW objects as described in Annex A, as well as any proprietary interfaces developed by the vendor, e.g., proprietary SNMP MIBs, CLI, WEB interface, etc.





As an example, as part of the staging of a new EQAM within an MSO network, specific information for the EQAM is configured, such as QAM frequencies, TSID values, TSID groups, Serving Group Names, QAM Group Names, DEPI session IDs, etc.

There **MUST** be a configuration option at the EQAM, via an Administrative Interface, to allow the EQAM to store the updated configuration in local non-volatile storage.

There **MUST** be a configuration option at the EQAM, via an Administrative Interface, to allow the EQAM to generate an XML configuration file and upload it via TFTP to a remote configuration file server with a specific file name.

Table 7–1 summarizes the steps involved in modifying the EQAM configuration and uploading it using TFTP.

Table 7–1 - EQAM Configuration with Administrative Interface

	Management System	EQAM	Config Server	Description
1				Administrative interfaces (CLI/SNMP/WEB) used to modify EQAM configuration.
2				EQAM notifies MGT system about reconfiguration.
3				Administrative interface triggers generation and upload of XML file.
4				XML file transfer from EQAM to server to ensure up to date copy.

Given the fact that the EQAM-created XML configuration file contains the most up-to-date configuration information for this particular EQAM, the operator can use this interface to maintain a copy of the configuration details of the EQAM remotely. The same XML file can be used to replace the configuration file pointed to by DHCP (if the EQAM uses DHCP).

7.4 EQAM Configuration with XML File





Often, the vendor may need to make wide scale changes for large numbers of EQAMs in a certain serving group or region. Using the supplied specific interfaces on EQAMs to reconfigure them may prove to be unwieldy in the case of large numbers of EQAMs. Having the ability to modify the specified XML details within the per-EQAM configuration files, and subsequently forcing a re-download/application of the EQAM configuration files to the EQAMs in question, simplifies the configuration change process.

The EQAM MUST support a configuration option via the Administrative Interface in order to trigger the XML configuration file to be downloaded from a remote configuration file server (defined by a specific FILENAME), and subsequently applied to the EQAM configuration. The EQAM may or may not take into account any vendor-specific extensions contained in the configuration file during this update process.

When the downloaded configuration file contains updates to the QAM channel parameter configuration, the EQAM can send an ERMI-1 UPDATE message with a Service Status indicating "maintenance mode" for the particular QAM channel(s) affected. Once there are no active dynamic sessions and no traffic on the static UDP ports for each QAM channel, the channel is taken down, updates made, and then brought up and advertised with a new UPDATE.

Table 7–2 resumes the EQAM configuration step with the XML file.

Table 7–2 - EQAM Configuration With XML File

	Management System	EQAM	Config Server	Description
1				XML configuration file(s) modified by operator on the file server.
2				EQAM administrative interface sets up file transfer detail.
3				EQAM administrative interface triggers download of XML file.
4				XML configuration file is applied on EQAM.
5				EQAM notifies MGT if the configuration file can not be applied correctly.

7.5 Vendor-Specific Extensions

The vendor-specific extensions are a group in the XML file under the "VendorConfig" element. This element MUST include a "vendorId" attribute that uses the value of the private enterprise number (PEN) assigned by IANA. Other specific vendor extensions may be included in the "VendorConfig" element with XML special case "CDATA" construct or with standard XML sub elements. Those extensions are proprietary to the vendor. (The proprietary content is not defined here.)

The vendor configuration is applied first, followed by the standard XML configuration details. For example, if the vendor-specific configuration information contains a frequency of 800 MHz for a particular Downstream QAM channel; the content of the XML configuration would override the vendor-specific configuration, thus ensuring that the standard XML configuration options are always applied. This also applies in the case where an EQAM has a local configuration file, not part of the XML configuration file. The XML configuration file is always applied AFTER the local configuration file is applied.

7.6 XML Configuration File Checksum

The XML configuration file is downloaded and uploaded via TFTP between the EQAM and the file server. There exists a possibility that contents of the XML configuration file may get corrupted or lost during a TFTP transfer.

In order to prevent this from affecting EQAM operation, a simple procedure is defined here that employs the use of a checksum inserted as an XML tag in the XML configuration file.

The EQAM scans the XML configuration file after any TFTP download and if the XML tag for the checksum is present; then the EQAM verifies that the contents of the XML configuration file correspond to the checksum contained within. A [SHA-1] hash-based checksum is specified for use in the XML tag.

If the XML tag containing the checksum is present in the XML configuration file downloaded at the EQAM, the EQAM MUST remove the XML checksum tag and validate the contents of the file by re-calculating the [SHA-1] hash-based checksum over the remaining contents of the XML file. If the checksum validation fails, the EQAM MUST generate an appropriate event and reject the configuration file that it has downloaded.

The EQAM MUST provide a configuration mechanism by which the operator may invoke the EQAM to generate and include the XML checksum tag every time the EQAM generates the XML configuration file. The default value of this configuration is FALSE(2).

The schema for the XML checksum tag is defined in Annex B.2.

7.7 Configuration Error File

The EQAM SHOULD validate all the parameters supplied in the configuration file before applying any updates. If error(s) are encountered during configuration, then it MUST NOT apply any of the configuration settings from the file. If the configuration file cannot be applied on the EQAM, the EQAM MUST continue to operate with the configuration it had in place prior to the download.

When the configuration file cannot be applied on the EQAM, the EQAM MUST log an event (EventId 079XXXXX). The error must be in the following comma-separated field format.

Line number, Element/Attribute name, Error description

Example:

```
123, qamChannelFrequency, wrong value  
456, qamId, unknown QAM channel  
569, tsOutput, syntax error (missing ">")
```

The operator will get meaningful debugging information if carriage returns are applied as appropriate in the configuration file.

8 EQAM MANAGEMENT

This section defines the minimum set of managed objects required to be supported by the EQAM.

The requirements described in this specification have priority over other standard organizations' defined MIB modules (e.g., SCTE, IETF). They include MIB objects made mandatory in this specification, whereas the other standards may have defined them as deprecated, obsolete, or as having optional implementation compliances.

Unless otherwise indicated, the other standard organizations' defined deprecated, obsolete, or optional MIB objects that are supported by the EQAM device **MUST** be implemented correctly according to the MIB module definition.

If an EQAM device does not support a deprecated, obsolete, or optional MIB object, the device SNMP Agent **MUST NOT** instantiate the MIB object. If an EQAM device does not support a deprecated, obsolete, or optional MIB object, the device SNMP Agent **MUST** return the corresponding error code on SNMP PDU requests.

8.1 DOCSIS MIB Modules

Table 8–1 - DOCSIS MIB Modules

MIB	OSSI Requirements
DOCSIS M-CMTS Interface MIB: DOCS-IF-M-CMTS-MIB	A compliant EQAM device MUST support the DOCS-IF-M-CMTS-MIB module as described in Annex A.
DOCSIS Time Interface MIB: DTI-MIB	A compliant EQAM device MUST support the DTI-MIB module as described in Annex A.
DOCSIS QAM MIB: DOCS-QAM-MIB	A compliant EQAM device MUST support the DOCS-QAM-MIB module as described in Annex C.
DOCSIS DRF MIB: DOCS-DRF-MIB	A compliant EQAM device MUST support the DOCS-DRF-MIB module as described in Annex A.

8.2 IETF RFC MIB Modules

Table 8–2 - IETF RFC MIB Modules

MIB	OSSI Requirements
SNMPv2 Management Information Base for the Internet Protocol using SMIPv2: IP-MIB	A compliant EQAM device MUST support ipNetToMediaTable and ipAddrTable from the ipGroup [RFC 2011]. The EQAM-compliant device MAY support other objects of the ipGroup.
The Interfaces Group MIB using SMIPv2: IF-MIB	The Interface MIB [RFC 2863] MUST be implemented by compliant M-CMTS Cores, DTI Server, and EQAM devices, as described in Annex A. A compliant EQAM device MUST support the interface Type docsCableMCmtsDownstream for each QAM channel. A compliant EQAM device MUST have an instance of ifEntry for each M-CMTS Downstream Interface. The EQAM-compliant device MUST include entries in the ifStackTable [RFC 2863] of the M-CMTS Downstream interfaces. A compliant EQAM device MUST model the docsCableMCmtsDownstream interfaces at the top of the interface stack with no sub-interfaces.

MIB	OSSI Requirements
Layer Two Tunneling Protocol "L2TP" Management Information Base [RFC 3371], August 2002.	<p>The DOCS-IF-M-CMTS-MIB provides mechanisms for static configuration of DEPI L2TPv3 tunnels, as well as providing status information on dynamic DEPI L2TPv3 sessions created by other means, such as [SCTE 137-4]. The MIB table docsIfMCmtsDepsessionConfigTable follows a similar structure of Pseudo Wire (PW) MIB [PW-MIB].</p> <p>Therefore, the current L2TP-MIB [RFC 3371] reference to the TUNNEL-MIB [RFC 4087] is no longer needed.</p> <p>The current L2TP-MIB is based on L2TP protocol [RFC 2661] and has not been updated for L2TPv3 Pseudowire framework. As a result, some information and capability developed for L2TPv3 has not been reflected in the MIB.</p> <p>Because of this, the use of the L2TP-MIB [RFC 3371] is not required for a compliant M-CMTS Core or EQAM.</p>
SNMP v3 MIBs: <ul style="list-style-type: none"> • SNMP-FRAMEWORK-MIB, • SNMP-MPD-MIB, • SNMP-NOTIFICATION-MIB, • SNMP-TARGET-MIB, • SNMP-USER-BASED-SM-MIB, • SNMP-VIEW-BASED-ACM-MIB, • SNMP-COMMUNITY-MIB 	<p>A compliant EQAM device MUST support the SNMP v3 MIBs, as described in Annex A.</p>
Management Information Base (MIB) for the Simple Network Management Protocol (SNMP): SNMPv2-MIB	<p>The EQAM-compliant device MUST support the systemGroup of [RFC 3418]. Compliant EQAM and DTI Servers MUST support the MIB object snmpEnableAuthenTraps from the snmpGroup, and the notifications coldStart and authenticationFailure from the snmpBasicNotificationsGroup of [RFC 3418].</p>
Entity MIB: ENTITY-MIB	<p>A Compliant EQAM device MUST support the ENTITY-MIB objects as described in Annex A and [RFC 4133].</p> <p>Compliant QAM and DTI devices are not required to implement Logical Management Entities, as defined in [RFC 4133] (e.g., to manage multiple EQAM chassis as logical entities). Therefore, support of MIB objects from entLogical2Group is not required.</p> <p>A Compliant EQAM device MAY implement Logical Management Entities, in which case the entLogical2Group MUST be supported.</p> <p>A compliant EQAM MUST assign the ENTITY-MIB PhysicalClass type of 'port' to QAM channels. A compliant EQAM device MUST assign RF Ports the PhysicalClass 'module'. Other Physical Class types, such as 'stack,' 'chassis,' 'backplane,' 'module,' etc., are used as the ENTITY-MIB [RFC 4133] describes them.</p> <p>A compliant EQAM device MUST map Ethernet interfaces and QAM channels (Physical entities of Entity PhysicalClass equals 'port') to ifEntry interfaces by means of entAliasMappingEntry with entAliasMappingIdentifier equal to the respective instance of ifIndex.</p>

MIB	OSSI Requirements
DOCSIS RFI MIB: DOCS-IF-MIB	<p>The EQAM device MUST implement the conceptual table docsIfDownstreamTable as indicated in Annex A.</p> <p>The EQAM MUST report the transmit power in the MIB object docsIfDownChannelPower within 2 dB of the actual transmit power.</p>
DOCSIS Cable Device MIB: DOCS-CABLE-DEVICE-MIB	<p>The EQAM device MUST implement the docsDevEventGroup from [RFC 4639] as indicated in Annex A.</p>
IP-MIB	<p>The EQAM device MUST implement the IP-MIB [RFC 4293] as indicated in Annex A.</p> <p>The EQAM device MUST instantiate a row in the ipIfStatsTable for each Management interface. The EQAM device MAY instantiate a row in the ipIfStatsTable for each Data interface.</p> <p>The EQAM device MUST implement the counters in the IpGroup to reflect Management interface statistics. The EQAM device MAY include the Data interface statistics in the IpGroup counters.</p>

8.3 SCTE MIB Modules

Table 8-3 - SCTE MIB Modules

MIB	OSSI Requirements
Appendix I of SCTE-HMS-QAM-MIB	<p>The EQAM device MUST implement the SCTE-HMS-QAM-MIB from [SCTE 154-2] as defined in Annex A.</p>
Appendix III of SCTE-HMS-MPEG-MIB	<p>The EQAM device MUST implement the SCTE-HMS-MPEG-MIB from [SCTE 154-4] as defined in Annex A.</p>
A draft extension to the SCTE-HMS-MPEG-MIB [SCTE 154-4]	<p>Input TS data rate would be added as an extension table.</p> <p>inputTSStatsExtTable Data rate: data rate for the entire input transport stream. Bits per second.</p> <p>Input program stats table Data rate: data rate associated with each individual program. Bits per second.</p> <p>Output program stats table Data rate: data rate associated with each individual program. Bits per second.</p> <p>Dropped packets: Count for dropped packets for each individual program. (Note: Should be same syntax as OutputStatsDroppedPackets, count 32, need to verify).</p> <p>Re-introduce the Video Session Log table. This is optional as per the earlier FT discussions.</p>

9 EQAM FAULT REPORTING

This section defines requirements for remote monitoring/detection, diagnosis, reporting, and correction of problems.

9.1 SNMP Usage

SNMP is used to achieve the goals of fault management: remote detection, diagnosis, reporting, and correction of EQAM faults. The EQAM **MUST** support SNMP management traffic across the Management interface.

The EQAM SNMP access might be restricted by configuration parameters to support the operator's policy goals. Cable operators can use SNMP queries to perform diagnostics and fault classification.

The EQAM sends SNMP notifications to one or more NMSs (subject to operator-imposed policy). The EQAM sends events to a syslog server.

9.2 Event Notification

The EQAM is required to generate asynchronous events that indicate malfunction situations and notify about important events. The methods for reporting events are defined below:

1. Stored in Local Log (docsDevEventTable [RFC 4639]).
2. Reported to SNMP entities as an SNMP notification.
3. Sent as a message to a syslog server.

Event Notifications are enabled and disabled by configuration. IETF SNMP notifications normally define specific controls to enable and disable notifications. Events can be reported to local log as a syslog message and/or SNMP notification as defined in docsDevEvControlTable [RFC 4639] and Annex A. An EQAM supports event notification functions, including local event logging, syslog (limiting/throttling), and SNMP notification (limiting/throttling), as specified in [RFC 4639] and this specification. An EQAM is required to support SNMP trap control, as specified in [RFC 4639] and this specification.

9.2.1 Format of Events

The following sections explain in detail how to report these events by any of the three mechanisms (local event logging, SNMP notification, and syslog).

9.2.1.1 Local Event Logging

An EQAM **MUST** maintain Local Log events, defined in Annex A, in both local-volatile storage and local non-volatile storage. An EQAM **MAY** retain them in local non-volatile storage events designated for local volatile storage.

The EQAM **MUST** implement its Local Log as a cyclic buffer with a minimum of 300 entries. The EQAM Local Log non-volatile storage events **MUST** persist across reboots. The EQAM **MUST** provide access to the Local Log events through the docsDevEventTable [RFC 4639].

Aside from the procedures defined in this document, event recording conforms to the requirements of [RFC 4639]. Event descriptions are defined in English. An EQAM **MUST** implement event descriptors such that no event descriptor is longer than 255 characters, which is the maximum defined for SnmpAdminString [RFC 3411].

Events are identical if their EventIds are identical. For identical events occurring consecutively, the EQAM MAY choose to store only a single event. If an EQAM stores as a single event multiple identical events that occur consecutively, the EQAM MUST reflect the most recent event in the event description.

The EventId digit is a 32-bit unsigned integer. EventIds ranging [RFC 4639] from 0 to (231 - 1) are reserved by DOCSIS. The EQAM MUST report in the docsDevEvTable [RFC 4639] the EventId as a 32-bit unsigned integer, and convert the EventId from the error codes defined in Annex A to be consistent with this number format.

9.2.1.2 SNMP Notifications

An EQAM MUST implement the generic SNMP notifications according to Annex A.

When any event causes a generic SNMP notification occurrence in the EQAM, the EQAM MUST send notifications if throttling/limiting mechanisms defined in [RFC 4639] and other limitations [RFC 3413] do not restrict notification sending.

An EQAM MUST implement SNMP notifications defined in DOCS-IF3-MIB from Annex A.

The EQAM MUST send notifications for any event if docsDevEvControl object [RFC 4639], throttling/limiting mechanism [RFC 4639], and [RFC 3413] limitations applied later do not restrict notification sending.

9.2.1.3 Syslog message format

When the EQAM sends a syslog message for a defined event, the EQAM MUST send it in the following format:

<level>TIMESTAMP HOSTNAME EQAM[vendor]: <eventId> text vendor-specific-text

In which:

- level is an ASCII representation of the event priority, enclosed in angle brackets, which is constructed as an OR of the default Facility (128) and event priority (0-7). The resulting level ranges between 128 and 135.
- TIMESTAMP and HOSTNAME follow the format of [RFC 3164]. The single space after TIMESTAMP is part of the TIMESTAMP field. The single space after HOSTNAME is part of the HOSTNAME field.
- vendor is the vendor name for the vendor-specific syslog messages or DOCSIS for the standard DOCSIS messages.
- eventId is an ASCII representation of the INTEGER number in decimal format, enclosed in angle brackets, which uniquely identifies the type of event. The EQAM MUST equate the eventId with the value stored in the docsDevEvId object in docsDevEventTable. For the standard DOCSIS events this number is converted from the error code using the following rules:
 - The number is an eight-digit decimal number.
 - The first two digits (left-most) are the ASCII code for the letter in the Error code.
 - The next four digits are filled by two or three digits between the letter and the dot in the Error code with zero filling in the gap in the left side.
 - The last two digits are filled by the number after the dot in the Error code with zero filling in the gap in the left side.
- Text contains the textual description for the standard DOCSIS event message, as defined in Annex A.
- Vendor-specific-text contains vendor-specific information. This field is optional.

The EQAM MAY report non-DOCSIS events in the standard syslog message format [RFC 3164] rather than the DOCSIS syslog message format defined above.

When the EQAM sends a syslog message for an event not defined in this specification, the EQAM MAY send it according to the format and semantics of the elements defined above.

9.2.2 BIT Values for docsDevEvReporting [RFC 4639]

Permissible BIT values for [RFC 4639] docsDevEvReporting objects include:

- 1: local(0)
- 2: traps(1)
- 3: syslog(2)
- 4: localVolatile(8)
- 5: stdInterface(9)

Bit-0 means non-volatile Local Log storage and bit-8 are used for volatile Local Log storage (see Section 9.2.1). Bit-1 means SNMP Notifications correspond to both SNMP Trap and SNMP Inform.

The EQAM MUST use the bit-3 value to set both bit-3 and bit-8 for SNMP SET operations on docsDevEvReporting using a one-byte BITS encoded value; therefore, the EQAM reports bit-3 and bit-8 with identical values for SNMP GET operations.

The EQAM MUST use the bit-8 value to set bit-3 and bit-8 for SNMP SET operations, irrespective of the bit-3 value, on docsDevEvReporting using a two or more byte BITS encoded value.

The EQAM MAY support bit-9 in docsDevEvReporting BITS encoding in accordance with [RFC 4639] definition.

An EQAM that reports an event by SNMP Notification or syslog MUST also report the event by a Local Log (volatile or non-volatile).

Combinations of docsDevEvReporting with traps(1) and/or syslog(2) bits with no Local Log bits (bit-0, bit-3, or bit-8) set are known as unacceptable combinations.

The EQAM MUST accept any SNMP SET operation to docsDevEvReporting different than the unacceptable combinations.

The EQAM MUST ignore any undefined bits in docsDevEvReporting on SNMP SET operations and report a zero value for those bits.

9.2.3 Standard events for EQAM

The EQAM MUST support either volatile local log, non-volatile local log, or both.

If the EQAM supports both volatile and non-volatile storage, the EQAM MUST maintain the non-volatile storage when both non-volatile Local Log and volatile Local Log bits are set for a specific docsDevEvReporting event priority. If the EQAM supports both volatile and non-volatile storage, the EQAM MAY maintain the volatile storage when both non-volatile Local Log and volatile Local Log bits are set for a specific docsDevEvReporting event priority. When both non-volatile Local Log and volatile Local Log bits are set for a specific docsDevEvReporting event priority, the EQAM MUST NOT report duplicate events in the docsDevEventTable.

Emergency(1) events indicate fatal hardware or software failure that prevent normal system operation (all service are affected).

Alert(2) events indicate a major hardware or software failure that causes some service interruption (no redundancy available).

Critical(3) events indicate a major hardware or software failure that does not cause an interrupt of the normal data flow. This level of event may be also used when some redundant device was automatically activated to replace the defective device.

Error(4) events indicate that an incorrect input signal (external system error) is causing temporary or permanent interruption of the normal data flow.

Warning(5) events indicate a minor failure that does not cause any interrupt of the data flow.

Notice(6) events indicate that a specified alarm condition has been removed.

Information(7) events indicate a milestone or checkpoint in normal operation that could be of particular importance for troubleshooting.

Debug(8) events are reserved for vendor-specific events.

The reporting mechanism for each priority could be changed from the default reporting mechanism by using docsDevEvReporting object of DOCS-CABLE-DEVICE-MIB [RFC 4639].

Table 9–1 - Default event reporting mechanism versus priority (non-volatile Local Log support only)

Event Priority	Local Log Non-volatile	SNMP Notification	Syslog	Local Log Volatile
Emergency	Yes	No	No	Not Used
Alert	Yes	No	No	Not Used
Critical	Yes	Yes	Yes	Not Used
Error	Yes	Yes	Yes	Not Used
Warning	Yes	Yes	Yes	Not Used
Notice	Yes	Yes	Yes	Not Used
Informational	No	No	No	Not Used
Debug	No	No	No	Not Used

Table 9–2 - Default event reporting mechanism versus priority (volatile Local Log support only)

Event Priority	Local Log Non-volatile	SNMP Notification	Syslog	Local Log Volatile
Emergency	Not Used	No	No	Yes
Alert	Not Used	No	No	Yes
Critical	Not Used	Yes	Yes	Yes
Error	Not Used	Yes	Yes	Yes
Warning	Not Used	Yes	Yes	Yes
Notice	Not Used	Yes	Yes	Yes
Information	Not Used	No	No	No
Debug	Not Used	No	No	No

Table 9–3 - Default event reporting mechanism versus priority

Event Priority	Local Log Non-volatile	SNMP Notification	Syslog	Local Log Volatile
Emergency	Yes	No	No	No
Alert	Yes	No	No	No
Critical	Yes	Yes	Yes	No
Error	No	Yes	Yes	Yes
Warning	No	Yes	Yes	Yes
Notice	No	Yes	Yes	Yes
Information	No	No	No	No
Debug	No	No	No	No

9.2.4 Event Priorities and Vendor-Specific Events

This specification defines events to most of the Event priority Levels defined by this specification. Vendor-specific events can be defined for any Event Priority Level. Table 9–4 summarizes those considerations.

Table 9–4 - Event Priorities Assignment

Event Priority	EQAM Event Assignment
Emergency	Vendor Specific
Alert	PMI and Vendor Specific (optional*)
Critical	PMI and Vendor Specific (optional*)
Error	PMI and Vendor Specific (optional*)
Warning	PMI and Vendor Specific (optional*)
Notice	PMI and Vendor Specific (optional*)
Information	PMI and Vendor Specific (optional*)
Debug	Vendor Specific

*Note: Vendor-specific optional event definitions are recommended only where the CM/CMTS allows for sufficient storage of such events.

9.3 List of events

The following list of Events are indications of error conditions at the EQAM.

Process	Sub-Process	CMTS & EQAM Priority	Event Message	Message Notes and Details	Error Code Set	Event ID	Trap Name
EQAM DHCP Provisioning							
Eqam	EQAM-PMI	Critical	CDN; Result Code = 0;	for syslog & local-log Mandatory Add: ; Error Code = 0; Optional Add: <EC Text> Should Add in <EC Text>: "; PWType = <value>"	Q01.1	81000101	

Process	Sub-Process	CMTS & EQAM Priority	Event Message	Message Notes and Details	Error Code Set	Event ID	Trap Name
Eqam	EQAM-PMI	Critical	CDN; Result Code = 0;	for syslog & local-log Mandatory Add: ; Error Code = 0; Optional Add: <EC Text> Should Add in <EC Text>: "; PWType = <value>"	Q01.2	81000102	
EQAM Configuration File Download							
Eqam	EQAM-PMI	Critical	CDN; Result Code = 0;	for syslog & local-log Mandatory Add: ; Error Code = 0; Optional Add: <EC Text> Should Add in <EC Text>: "; PWType = <value>"	Q02.1	81000201	
Eqam	EQAM-PMI	Critical	CDN; Result Code = 0;	for syslog & local-log Mandatory Add: ; Error Code = 0; Optional Add: <EC Text> Should Add in <EC Text>: "; PWType = <value>"	Q02.2	81000202	
EQAM Configuration File Processing							
Eqam	EQAM-PMI	Critical	CDN; Result Code = 0;	for syslog & local-log Mandatory Add: ; Error Code = 0; Optional Add: <EC Text> Should Add in <EC Text>: "; PWType = <value>"	E03.1	81000301	
Eqam	EQAM-PMI	Critical	CDN; Result Code = 0;	for syslog & local-log Mandatory Add: ; Error Code = 0; Optional Add: <EC Text> Should Add in <EC Text>: "; PWType = <value>"	Q03.2	81000302	

Process	Sub-Process	CMTS & EQAM Priority	Event Message	Message Notes and Details	Error Code Set	Event ID	Trap Name
EQAM ERM1							
Eqam	EQAM-PMI	Critical	CDN; Result Code = 0;	for syslog & local-log Mandatory Add: ; Error Code = 0; Optional Add: <EC Text> Should Add in <EC Text>: "; PWType = <value>"	Q04.1	81000401	Session Loss (Unicast or Multicast)
Eqam	EQAM-PMI	Critical	CDN; Result Code = 0;	for syslog & local-log Mandatory Add: ; Error Code = 0; Optional Add: <EC Text> Should Add in <EC Text>: "; PWType = <value>"	Q03.2	81000302	Link Down Loss of Service
Eqam	EQAM-PMI	Critical	CDN; Result Code = 0;	for syslog & local-log Mandatory Add: ; Error Code = 0; Optional Add: <EC Text> Should Add in <EC Text>: "; PWType = <value>"	Q03.3	81000303	# of Sessions Lost & # of Sessions fail-over
Eqam	EQAM-PMI	Critical	CDN; Result Code = 0;	for syslog & local-log Mandatory Add: ; Error Code = 0; Optional Add: <EC Text> Should Add in <EC Text>: "; PWType = <value>"	Q03.4	81000304	Excessive network jitter in session, jitter buffer overflow

Annex A Detailed MIB Requirements (normative)

The abbreviations and rules in Table A–1 apply in this Annex.

Table A–1 - MIB Implementation Support

Requirement Type	Table Notation	Description
Deprecated	D	Deprecated objects are optional. If a vendor chooses to implement the object, the object must be implemented correctly according to the MIB definition. If a vendor chooses not to implement the object, an agent must not instantiate such object and must respond with the appropriate error/exception condition (e.g., 'noSuchObject' for SNMPv2c).
Mandatory	M	The object must be implemented correctly according to the MIB definition.
Not Applicable	NA	Not applicable to the device.
Not Supported	N-Sup	An agent must instantiate such object and must respond with the appropriate error/exception condition (e.g., 'noSuchObject' for SNMPv2c).
Optional	O	A vendor can choose to implement or not implement the object. If a vendor chooses to implement the object, the object must be implemented correctly according to the MIB definition. If a vendor chooses not to implement the object, an agent must not instantiate such object and must respond with the appropriate error/exception condition (e.g., 'noSuchObject' for SNMPv2c).
Obsolete	Ob	In SNMP convention, obsolete objects should not be implemented. This specification allows vendors to implement or not implement obsolete objects. If a vendor chooses to implement an obsoleted object, the object must be implemented correctly according to the MIB definition. If a vendor chooses not to implement the obsoleted object, the SNMP agent must not instantiate such object and must respond with the appropriate error/exception condition (e.g., 'noSuchObject' for SNMPv2c).
Should	S	Should. A vendor SHOULD implement the object. If a vendor implements the object, the object MUST be implemented correctly according to the MIB definition. If a vendor does not implement the object, an agent MUST NOT instantiate such object and MUST respond with the appropriate error/exception condition (e.g., no such object for SNMPv2c).

Table A–2 - SNMP Access Requirements

SNMP Access Type	Table Notation	Description
N-Acc	Not Accessible	The object is not accessible and is usually an index in a table
Read Create	RC	The access of the object MUST be implemented as Read-Create
Read Write	RW	The access of the object MUST be implemented as Read-Only
Read Only	RO	The access of the object MUST be implemented as Read-Write
Read Create or Read Only	RC/RO	The access of the object MUST be implemented as either Read-Create or Read-Only as described in the MIB definition

SNMP Access Type	Table Notation	Description
Read Write / Read Only	RW/RO	The access of the object MUST be implemented as either Read-Write or Read-Only as described in the MIB definition
Accessible for SNMP Notifications	Acc-FN	These objects are used for SNMP Notifications by the CMTS and CM SNMP Agents
Accessible through SNMP Trap	ATRAP	These objects are accessible through SNMP traps.

A.1 Object Model schema Definition

The table below lists the EQAM device compliance requirements summary.

Table A-3 - Requirements

DOCS-IF-MIB [RFC 4546]				
docsIfDownstreamChannelTable				
Objects	M-CMTS EQAM	Access	VIDEO EQAM	Access
docsIfDownChannelId	NA		NA	
docsIfDownChannelFrequency	M	RO	M	RO
docsIfDownChannelWidth	M	RO	M	RO
docsIfDownChannelModulation	M	RO	M	RO
docsIfDownChannelInterleave	M	RO	M	RO
docsIfDownChannelPower	M	RO	M	RO
docsIfDownChannelAnnex	O	RO	O	RO
SCTE-HMS-QAM-MIB [SCTE 154-2]				
qamChannelTable				
Objects	M-CMTS EQAM	Access	VIDEO EQAM	Access
qamChannelModulationFormat	O	RO	M	RO
qamChannelInterleaverLevel	O	RO	M	RO
qamChannelInterleaverMode	O	RO	M	RO
qamChannelPower	O	RO	M	RO
qamChannelSquelch	O	RO	M	RO
qamChannelContWaveMode	O	RO	M	RO
qamChannelAnnexMode	O	RO	M	RO

qamChannelCommonTable				
Objects	M-CMTS EQAM	Access	VIDEO EQAM	Access
qamChannelCommonOutputBw	O	RO	M	RO
qamChannelCommonUtilization	O	RO	M	RO
qamConfigTable				
Objects	M-CMTS EQAM	Access	VIDEO EQAM	Access
qamConfigIndex	O	N-Acc	M	N-Acc
qamConfigQamChannelIdMin	O	RO	M	RO
qamConfigQamChannelIdMax	O	RO	M	RO
qamConfigIPAddrType	O	RO	M	RO
qamConfigIPAddr	O	RO	M	RO
qamConfigUdpPortRangeMin	O	RO	M	RO
qamConfigUdpPortRangeMax	O	RO	M	RO
qamConfigOutputProgNoMin	O	RO	M	RO
qamConfigOutputProgNoMax	O	RO	M	RO
SCTE-HMS-MPEG-MIB [SCTE 154-4]				
mpegDigitalInputs				
Object	M-CMTS EQAM	Access	VIDEO EQAM	Access
mpegLossOfSignalTimeout	O	RO	M	RO
mpegInputTSTable				
Objects	M-CMTS EQAM	Access	VIDEO EQAM	Access
mpegInputTSIndex	O	N-Acc	M	N-Acc
mpegInputTSType	O	RO	M	RO
mpegInputTSConnectionType	O	RO	M	RO
mpegInputTSConnection	O	RO	M	RO
mpegInputTSPsiDetected	O	RO	M	RO
mpegInputTSStartTime	O	RO	M	RO
mpegInputTSResourceAllocated	O	RO	M	RO
mpegInputTSNumPrograms	O	RO	M	RO
mpegInputTSRate	O	RO	M	RO
mpegInputTSMMaxRate	O	RO	M	RO
mpegInputTSPatVersion	O	RO	M	RO
mpegInputTSCatVersion	O	RO	M	RO
mpegInputTSNitPid	O	RO	M	RO
mpegInputTSNumEmms	O	RO	M	RO

mpegInputTSTSID	O	RO	M	RO
mpegInputTSLock	O	RO	O	RO
mpegInputProgTable				
Objects	M-CMTS EQAM	Access	VIDEO EQAM	Access
mpegInputProgIndex	O	N-Acc	M	N-Acc
mpegInputProgNo	O	RO	M	RO
mpegInputProgPmtVersion	O	RO	M	RO
mpegInputProgPmtPid	O	RO	M	RO
mpegInputProgPcrPid	O	RO	M	RO
mpegInputProgEcmPid	O	RO	M	RO
mpegInputProgNumElems	O	RO	M	RO
mpegInputProgNumEcms	O	RO	M	RO
mpegInputProgCaDescr	O	RO	M	RO
mpegInputProgScte35Descr	O	RO	O	RO
mpegInputProgScte18Descr	O	RO	O	RO
mpegProgESTable				
Objects	M-CMTS EQAM	Access	VIDEO EQAM	Access
mpegProgESIndex	O	N-Acc	M	N-Acc
mpegProgESPID	O	RO	M	RO
mpegProgESType	O	RO	M	RO
mpegProgESCaDescr	O	RO	M	RO
mpegProgESScte35Descr	O	RO	O	RO
mpegProgESScte18Descr	O	RO	O	RO
mpegInputStatsTable				
Objects	M-CMTS EQAM	Access	VIDEO EQAM	Access
mpegInputStatsPcrJitter	O	RO	M	RO
mpegInputStatsMaxPacketJitter	O	RO	M	RO
mpegInputStatsPcrPackets	O	RO	M	RO
mpegInputStatsNonPcrPackets	O	RO	M	RO
mpegInputStatsUnexpectedPackets	O	RO	M	RO
mpegInputStatsContinuityErrors	O	RO	M	RO
mpegInputStatsSyncLossPackets	O	RO	M	RO

mpegInputUdpOriginationTable				
Objects	M-CMTS EQAM	Access	VIDEO EQAM	Access
mpegInputUdpOriginationIndex	O	N-Acc	M	N-Acc
mpegInputUdpOriginationId	O	N-Acc	M	N-Acc
mpegInputUdpOriginationInetAddrType	O	RO	M	RO
mpegInputUdpOriginationSrcInetAddr	O	RO	M	RO
mpegInputUdpOriginationDestInetAddr	O	RO	M	RO
mpegInputUdpOriginationDestPort	O	RO	M	RO
mpegInputUdpOriginationActive	O	RO	M	RO
mpegInputUdpOriginationIfIndex	O	RO	M	RO
mpegInputUdpOriginationPacketsDetected	O	RO	M	RO
mpegInputUdpOriginationRank	O	RO	M	RO
mpegOutputs	O	RO	M	RO
mpegInsertPacketTable				
Objects	M-CMTS EQAM	Access	VIDEO EQAM	Access
mpegInsertPacketIndex	O	N-Acc	M	N-Acc
mpegInsertPacketListId	O	RO	M	RO
mpegInsertPacketImmediateExecution	O	RO	M	RO
mpegInsertPacketStartTime	O	RO	M	RO
mpegInsertPacketRepeat	O	RO	M	RO
mpegInsertPacketContinuousFlag	O	RO	M	RO
mpegInsertPacketRate	O	RO	M	RO
mpegInsertPacketDeviceIndex	O	RO	M	RO
mpegOutputStatsTable				
Objects	M-CMTS EQAM	Access	VIDEO EQAM	Access
mpegOutputStatsDroppedPackets	O	RO	M	RO
mpegOutputStatsFifoOverflow	O	RO	M	RO
mpegOutputStatsFifoUnderflow	O	RO	M	RO
mpegOutputStatsDataRate	O	RO	M	RO
mpegOutputStatsAvailableBandwidth	O	RO	M	RO
mpegOutputStatsChannelUtilization	O	RO	M	RO
mpegOutputStatsTotalPackets	O	RO	M	RO

mpegOutputTSTable				
Objects	M-CMTS EQAM	Access	VIDEO EQAM	Access
mpegOutputTSIndex	O	N-Acc	M	N-Acc
mpegOutputTSType	O	RO	M	RO
mpegOutputTSConnectionType	O	RO	M	RO
mpegOutputTSConnection	O	RO	M	RO
mpegOutputTSNumPrograms	O	RO	M	RO
mpegOutputTSTSID	O	RO	M	RO
mpegOutputTSNitPid	O	RO	M	RO
mpegOutputTSCaPid	O	RO	M	RO
mpegOutputTSCatInsertRate	O	RO	M	RO
mpegOutputTSPatInsertRate	O	RO	M	RO
mpegOutputTSPmtInsertRate	O	RO	M	RO
mpegOutputTSStartTime	O	RO	M	RO
mpegOutputProgTable				
Objects	M-CMTS EQAM	Access	VIDEO EQAM	Access
mpegOutputProgIndex	O	N-Acc	M	N-Acc
mpegOutputProgNo	O	RO	M	RO
mpegOutputProgPmtVersion	O	RO	M	RO
mpegOutputProgPmtPid	O	RO	M	RO
mpegOutputProgPcrPid	O	RO	M	RO
mpegOutputProgEcmPid	O	RO	M	RO
mpegOutputProgNumElems	O	RO	M	RO
mpegOutputProgNumEcms	O	RO	M	RO
mpegOutputProgCaDescr	O	RO	M	RO
mpegOutputProgScte35Descr	O	RO	O	RO
mpegOutputProgScte18Descr	O	RO	O	RO
mpegOutputProgElemStatsTable				
Objects	M-CMTS EQAM	Access	VIDEO EQAM	Access
mpegOutputProgElemStatsIndex	O	N-Acc	M	N-Acc
mpegOutputProgElemStatsPid	O	RO	M	RO
mpegOutputProgElemStatsElemType	O	RO	M	RO
mpegOutputProgElemStatsDataRate	O	RO	O	RO

mpegOutputUdpDestinationTable				
Objects	M-CMTS EQAM	Access	VIDEO EQAM	Access
mpegOutputUdpDestinationIndex	NA		NA	
mpegOutputUdpDestinationId	NA		NA	
mpegOutputUdpDestinationInetAddrType	NA		NA	
mpegOutputUdpDestinationSrcInetAddr	NA		NA	
mpegOutputUdpDestinationDestInetAddr	NA		NA	
mpegOutputUdpDestinationDestPort	NA		NA	
mpegOutputUdpDestinationIfIndex	NA		NA	
mpegProgramMappingTable				
Objects	M-CMTS EQAM	Access	VIDEO EQAM	Access
mpegProgramMappingIndex	O	N-Acc	M	N-Acc
mpegProgramMappingOutputProgIndex	O	RO	M	RO
mpegProgramMappingOutputTSIndex	O	RO	M	RO
mpegProgramMappingInputProgIndex	O	RO	M	RO
mpegProgramMappingInputTSIndex	O	RO	M	RO
mpegVideoSessionTable				
Objects	M-CMTS EQAM	Access	VIDEO EQAM	Access
mpegVideoSessionIndex	O	N-Acc	M	N-Acc
mpegVideoSessionPhyMappingIndex	O	RO	M	RO
mpegVideoSessionPIDRemap	O	RO	M	RO
mpegVideoSessionMode	O	RO	M	RO
mpegVideoSessionState	O	RO	M	RO
mpegVideoSessionProvMethod	O	RO	M	RO
mpegVideoSessionEncryptionType	O	RO	M	RO
mpegVideoSessionEncryptionInfo	O	RO	M	RO
mpegVideoSessionBitRate	O	RO	M	RO
mpegVideoSessionID	O	RO	M	RO
mpegVideoSessionSelectedInput	O	RO	M	RO
mpegVideoSessionSelectedOutput	O	RO	M	RO

mpegVideoSessionPtrTable				
Objects	M-CMTS EQAM	Access	VIDEO EQAM	Access
mpegVideoSessionPtrInputProgIndex	O	N-Acc	M	N-Acc
mpegVideoSessionPtrInputTSIndex	O	RO	M	RO
mpegVideoSessionPtrInputTSConnType	O	RO	M	RO
mpegVideoSessionPtrInputTSConnection	O	RO	M	RO
mpegVideoSessionPtrOutputProgIndex	O	RO	M	RO
mpegVideoSessionPtrOutputTSIndex	O	RO	M	RO
mpegVideoSessionPtrOutputTSConnType	O	RO	M	RO
mpegVideoSessionPtrOutputTSConnection	O	RO	M	RO
mpegVideoSessionPtrStatus	O	RO	M	RO
DOCS-DRF-MIB [SCTE 137-3]				
docsDrfDownstreamTable				
Object	M-CMTS EQAM	Access	VIDEO EQAM	Access
docsDrfDownstreamPhyDependencies	NA		NA	
docsDrfDownstreamCapabTable				
Objects	M-CMTS EQAM	Access	VIDEO EQAM	Access
docsIfMCmtsEqamDownstreamCapabFrequency	M	RO	O	RO
docsIfMCmtsEqamDownstreamCapabBandwidth	M	RO	O	RO
docsIfMCmtsEqamDownstreamCapabPower	M	RO	O	RO
docsIfMCmtsEqamDownstreamCapabModulation	M	RO	O	RO
docsIfMCmtsEqamDownstreamCapabInterleaver	M	RO	O	RO
docsIfMCmtsEqamDownstreamCapabJ83Annex	M	RO	O	RO
docsIfMCmtsEqamDownstreamCapabConcurrentServices	M	RO	O	RO
docsIfMCmtsEqamDownstreamCapabServicesTransport	M	RO	O	RO
docsIfMCmtsEqamDownstreamCapabMuting	M	RO	O	RO
docsDrfGroupDependencyTable				
Objects	M-CMTS EQAM	Access	VIDEO EQAM	Access
docsDrfGroupDependencyPhyParam	M	N-Acc	O	N-Acc
docsDrfGroupDependencyPhysicalIndex	M	N-Acc	O	N-Acc
docsDrfGroupDependencyGroupID	M	RO	O	RO
docsDrfGroupDependencyType	M	RO	O	RO

docsDrfChannelBlockTable				
Objects	M-CMTS EQAM	Access	VIDEO EQAM	Access
docsDrfChannelBlockPhysicalIndex	M	N-Acc	M	N-Acc
docsDrfChannelBlockNumberChannels	M	RO	M	RO
docsDrfChannelBlockCfgNumberChannels	M	RO	M	RO
docsDrfChannelBlockMute	M	RO	M	RO
docsDrfChannelBlockTestType	M	RO	M	RO
docsDrfChannelBlockTestIfIndex	M	RO	M	RO
DOCS-IF-M-CMTS-MIB [SCTE 137-3]				
docsIfMCmtsEqamDownstreamTable				
Objects	M-CMTS EQAM	Access	VIDEO EQAM	Access
docsIfMCmtsEqamDownstreamTSID	M	RO	M	RO
docsIfMCmtsEqamDownstreamPhyDependencies	M	RO	M	RO
docsIfMCmtsEqamDownstreamDevicePhyParamLock	M	RO	M	RO
docsIfMCmtsEqamDownstreamDeviceConfigPhyParamLock	M	RO	M	RO
docsIfMCmtsEqamDownstreamAllocationType	M	RO	M	RO
docsIfMCmtsEqamDownstreamAllocationStatus	M	RO	M	RO
docsIfMCmtsEqamDownstreamAllocationTimeout	M	RO	M	RO
docsIfMCmtsEqamDownstreamDRRPAdvertizing	M	RO	M	RO
docsIfMCmtsEqamDownstreamUdpPortMapping	M	RO	M	RO
docsIfMCmtsEqamGlobCfgDownTable				
Objects	M-CMTS EQAM	Access	VIDEO EQAM	Access
docsIfMCmtsEqamGlobCfgDownIndex	M	N-Acc	O	N-Acc
docsIfMCmtsEqamGlobCfgDownPhysicalIndex	M	RC	O	RC
docsIfMCmtsEqamGlobCfgDownBandwidth	M	RC	O	RC
docsIfMCmtsEqamGlobCfgDownPower	M	RC	O	RC
docsIfMCmtsEqamGlobCfgDownModulation	M	RC	O	RC
docsIfMCmtsEqamGlobCfgDownInterleave	M	RC	O	RC
docsIfMCmtsEqamGlogCfgDownAnnex	M	RC	O	RC
docsIfMCmtsEqamGlobCfgDownSymbolRateM	M	RC	O	RC
docsIfMCmtsEqamGlobCfgDownSymbolRateN	M	RC	O	RC
docsIfMCmtsEqamGlobCfgDownLockParams	M	RC	O	RC
docsIfMCmtsEqamGlobCfgDownExecutionCode	M	RO	O	RO
docsIfMCmtsEqamGlobCfgDownErrorsCount	M	RO	O	RO
docsIfMCmtsEqamGlobCfgDownRowStatus	M	RC	O	RC

docsIfMCmtsDepsessionConfigTable				
Objects	M-CMTS EQAM	Access	VIDEO EQAM	Access
docsIfMCmtsDepsessionConfigIndex	M	N-Acc	NA	
docsIfMCmtsDepsessionConfigCableMacIfIndex	M	RC/RO	NA	
docsIfMCmtsDepsessionConfigCableDownfIndex	M	RC/RO	NA	
docsIfMCmtsDepsessionConfigAddrType	M	RC/RO	NA	
docsIfMCmtsDepsessionConfigLocalAddr	M	RC/RO	NA	
docsIfMCmtsDepsessionConfigRemoteAddr	M	RC/RO	NA	
docsIfMCmtsDepsessionConfigL2TPv3HeaderType	M	RC/RO	NA	
docsIfMCmtsDepsessionConfigMethod	M	RC/RO	NA	
docsIfMCmtsDepsessionConfigTSID	M	RC/RO	NA	
docsIfMCmtsDepsessionConfigDEPIMode	M	RC/RO	NA	
docsIfMCmtsDepsessionConfigRsrcAllocReq	M	RC/RO	NA	
docsIfMCmtsDepsessionConfigCinPhbldPolicy	M	RC/RO	NA	
docsIfMCmtsDepsessionConfigSyncEnabled	M	RC/RO	NA	
docsIfMCmtsDepsessionConfigSyncInterval	M	RC/RO	NA	
docsIfMCmtsDepsessionConfigPhyParamsFlag	M	RC/RO	NA	
docsIfMCmtsDepsessionConfigChannelFrequency	M	RC/RO	NA	
docsIfMCmtsDepsessionConfigChannelModulation	M	RC/RO	NA	
docsIfMCmtsDepsessionConfigChannelInterleave	M	RC/RO	NA	
docsIfMCmtsDepsessionConfigChannelPower	M	RC/RO	NA	
docsIfMCmtsDepsessionConfigChannelAnnex	M	RC/RO	NA	
docsIfMCmtsDepsessionConfigChannelSymbolRateM	M	RC/RO	NA	
docsIfMCmtsDepsessionConfigChannelSymbolRateN	M	RC/RO	NA	
docsIfMCmtsDepsessionConfigChannelOutputRate	M	RC/RO	NA	
docsIfMCmtsDepsessionConfigChannelBurstSize	M	RC/RO	NA	
docsIfMCmtsDepsessionConfigStorage	M	RC/RO	NA	
docsIfMCmtsDepsessionConfigRowStatus	M	RC/RO	NA	
docsIfMCmtsDepsessionConfigChannelId	N-Sup		NA	
docsIfMCmtsDepsessionInfoTable				
Objects	M-CMTS EQAM	Access	VIDEO EQAM	Access
docsIfMCmtsDepsessionInfoCfgIndex	M	RO	NA	
docsIfMCmtsDepsessionInfoUdpPort	M	RO	NA	
docsIfMCmtsDepsessionInfoMaxPayload	M	RO	NA	
docsIfMCmtsDepsessionInfoPathPayload	M	RO	NA	
docsIfMCmtsDepsessionInfoIncludeDOCSISMsgs	M	RO	NA	

docsIfMCmtsDepsessionInfoRsrcAllocResp	M	RO	NA	
docsIfMCmtsDepsessionInfoConnCtrlID	M	RO	NA	
docsIfMCmtsDepsessionInfoEQAMSessionID	M	RO	NA	
docsIfMCmtsDepsessionInfoOwner	M	RO	NA	
docsIfMCmtsDepsessionInfoState	M	RO	NA	
docsIfMCmtsDepsessionInfoErrorCode	M	RO	NA	
docsIfMCmtsDepsessionInfoCreationTime	M	RO	NA	
docsIfMCmtsDepsessionInfoStorage	M	RO	NA	
docsIfMCmtsDepsessionInfoRsrcAllocTable				
Objects	M-CMTS EQAM	Access	VIDEO EQAM	Access
docsIfMCmtsDepsessionInfoRsrcAllocIndex	O	RC/RO	NA	
docsIfMCmtsDepsessionInfoRsrcAllocSeq	O	RC/RO	NA	
docsIfMCmtsDepsessionInfoRsrcAllocPhbId	O	RC/RO	NA	
docsIfMCmtsDepsessionInfoRsrcAllocFlowId	O	RC/RO	NA	
docsIfMCmtsDepsessionInfoRsrcAllocUdpPort	O	RC/RO	NA	
docsIfMCmtsDepsessionInfoRsrcAllocPolicySenTags	O	RC/RO	NA	
docsIfMCmtsDepsessionInfoRsrcAllocStorage	O	RC/RO	NA	
docsIfMCmtsDepsessionInfoRsrcAllocRowStatus	O	RC/RO	NA	
docsIfMCmtsDepsessionInfoStatsTable				
Objects	M-CMTS EQAM	Access	VIDEO EQAM	Access
docsIfMCmtsDepsessionInfoOutOfSequencePkts	M	RO	NA	
docsIfMCmtsDepsessionInfoCinLatency				
Objects	M-CMTS EQAM	Access	VIDEO EQAM	Access
docsIfMCmtsDepsessionInfoCinLatencyInterval	M	RO	NA	
docsIfMCmtsDepsessionInfoCinLatencyThrshld	M	RO	NA	
docsIfMCmtsDepsessionInfoCinEventLevel	M	RO	NA	
docsIfMCmtsDepsessionInfoCinLastValue	M	RO	NA	
docsIfMCmtsDepsessionInfoCinLastValueIfIndex	M	RO	NA	
docsIfMCmtsDepsessionInfoCinLatencyValueLastTime	M	RO	NA	
docsIfMCmtsDepsessionInfoCinLatencyPerf				
Objects	M-CMTS EQAM	Access	VIDEO EQAM	Access
docsIfMCmtsDepsessionInfoCinLatencyPerfIntervalSeq	O	RO	O	RO
docsIfMCmtsDepsessionInfoCinLatencyPerfValue	O	RO	O	RO
docsIfMCmtsDepsessionInfoCinLatencyTime	O	RO	O	RO

docsIfMCmtsDepsPhbPolicyTable				
Objects	M-CMTS EQAM	Access	VIDEO EQAM	Access
docsIfMCmtsDepsPhbPolicyTag	NA		NA	
docsIfMCmtsDepsPhbPolicySCN	NA		NA	
docsIfMCmtsDepsPhbPolicyCinPhbId	NA		NA	
docsIfMCmtsDepsPhbPolicyStorage	NA		NA	
docsIfMCmtsDepsPhbPolicyRowStatus	NA		NA	
docsIfMCmtsQosServiceFlowExtTable				
Objects	M-CMTS EQAM	Access	VIDEO EQAM	Access
docsIfMCmtsQosServiceFlowExtDepsFlowId	NA		NA	
docsIfMCmtsQosServiceFlowExtCinPhbId	NA		NA	
docsIfMCmtsQosServiceFlowExtDepsIfIndex	NA		NA	
DTI-MIB [SCTE 137-3]				
dtiProtocolTable				
Objects	M-CMTS EQAM	Access	VIDEO EQAM	Access
dtiProtocolEntityType	M	RO	O	RO
dtiProtocolClientClockType	M	RO	O	RO
dtiProtocolServerStatusFlag	M	RO	O	RO
dtiProtocolClientStatusFlag	M	RO	O	RO
dtiProtocolServerToDState	M	RO	O	RO
dtiProtocolServerToDType	M	RO	O	RO
dtiProtocolServerToDValue	M	RO	O	RO
dtiProtocolServerCableAdvanceFlag	M	RO	O	RO
dtiProtocolServerCableAdvanceValue	M	RO	O	RO
dtiProtocolClientPhaseError	M	RO	O	RO
dtiProtocolClientVersion	M	RO	O	RO
dtiProtocolClientPathTraceability	M	RO	O	RO
dtiProtocolControlTable				
Objects	M-CMTS EQAM	Access	VIDEO EQAM	Access
dtiProtocolControlTimeInterval	NA		NA	
dtiProtocolControlErrorRateInterval	M	RO	O	RO
dtiProtocolControlJitterTimeInterval	NA		NA	
dtiProtocolControlTestMode	NA		NA	
dtiProtocolControlToDValue	NA		NA	

dtiProtocolPerformanceTable				
Objects	M-CMTS EQAM	Access	VIDEO EQAM	Access
dtiProtocolPerformanceDelay	NA		NA	
dtiProtocolPerformanceFrameErrorRate	M	RO	O	RO
dtiProtocolPerformancePeakToPeakJitter	NA		NA	
dtiProtocolPerformanceWander35Second	NA		NA	
dtiProtocolPerformanceWanderTSeconds	NA		NA	
dtiProtocolPerformanceFrameErrorRateScale	M	RO	O	RO
dtiPathTraceabilityTable				
Objects	M-CMTS EQAM	Access	VIDEO EQAM	Access
dtiPathTraceabilityIndex	M	RO	O	RO
dtiPathTraceabilityRootServerInetAddrType	M	RO	O	RO
dtiPathTraceabilityRootServerInetAddr	M	RO	O	RO
dtiPathTraceabilityRootServerOutPhyIdx	M	RO	O	RO
dtiPathTraceabilityServerInetAddrType	M	RO	O	RO
dtiPathTraceabilityServerInetAddr	M	RO	O	RO
dtiPathTraceabilityServerOutPhyIdx	M	RO	O	RO
dtiPathTraceabilityRootServerProtVersion	M	RO	O	RO
dtiPathTraceabilityServerProtVersion	M	RO	O	RO
dtiProtocolClientFsmStatsTable				
Objects	M-CMTS EQAM	Access	VIDEO EQAM	Access
dtiProtocolClientFsmStatsT3Count	M	RO	O	RO
dtiProtocolClientFsmStatsT4Count	M	RO	O	RO
dtiProtocolClientFsmStatsT6Count	M	RO	O	RO
dtiProtocolClientFsmStatsT7Count	M	RO	O	RO
dtiProtocolClientFsmStatsNormalActiveTime	M	RO	O	RO
dtiProtocolClientFsmStatsHoldoverActiveTime	M	RO	O	RO
DOCS-CABLE-DEVICE-MIB [RFC 4639]				
docsDevBase				
docsDevEventGroup				
Objects	M-CMTS EQAM	Access	VIDEO EQAM	Access
docsDevEvControl	M	RO	M	RO
docsDevEvThrottleAdminStatus	M	RO	M	RO
docsDevEvThrottleInhibited	M	RO	M	RO

docsDevEvThrottleThreshold	M	RO	M	RO
docsDevEvThrottleInterval	M	RO	M	RO
docsDevEvControlTable				
Objects	M-CMTS EQAM	Access	VIDEO EQAM	Access
docsDevEvPriority	M	N-Acc	M	N-Acc
docsDevEvReporting	M	RO	M	RO
docsDevEvControlTable				
Objects	M-CMTS EQAM	Access	VIDEO EQAM	Access
docsDevEvIndex	M	N-Acc	M	N-Acc
docsDevEvFirstTime	M	RO	M	RO
docsDevEvLastTime	M	RO	M	RO
docsDevEvCounts	M	RO	M	RO
docsDevEvLevel	M	RO	M	RO
docsDevEvId	M	RO	M	RO
docsDevEvText	M	RO	M	RO
docsDevSoftware				
Objects	M-CMTS EQAM	Access	VIDEO EQAM	Access
docsDevSwFilename	M	RW	M	RW
docsDevSwAdminStatus	M	RW	M	RW
docsDevSwOperStatus	M	RO	M	RO
docsDevSwCurrentVers	M	RO	M	RO
docsDevSwServerAddressType	M	RO	M	RO
docsDevSwServerAddress	M	RO	M	RO
docsDevSwServerTransportProtocol	M	RO	M	RO
docsDevServer				
Objects	M-CMTS EQAM	Access	VIDEO EQAM	Access
docsDevServerConfigFile	M	RW	M	RW
docsDevServerDhcpAddressType	M	RO	M	RO
docsDevServerDhcpAddress	M	RO	M	RO
docsDevServerTimeAddressType	M	RO	M	RO
docsDevServerTimeAddress	M	RO	M	RO
docsDevServerConfigTftpAddressType	M	RW	M	RW
docsDevServerConfigTftpAddress	M	RW	M	RW

EQAM-MIB Annex C				
docsQamControlTable				
Objects	M-CMTS EQAM	Access	VIDEO EQAM	Access
Reset	M	RW	M	RW
InitCause	M	RO	M	RO
SaveCfg	M	RW	M	RW
UploadCfg	M	RW	M	RW
docsQamNotify				
Objects	M-CMTS EQAM	Access	VIDEO EQAM	Access
docsQamResetnotify	M	Notify	M	Notify
IF-MIB [RFC 2863]				
Interfaces				
Objects	M-CMTS EQAM	Access	VIDEO EQAM	Access
ifNumber	M	RO	M	RO
IfTableLastChange	M	RO	M	RO
ifTable				
Objects	M-CMTS EQAM	Access	VIDEO EQAM	Access
IfIndex	M	RO	M	RO
ifDescr	M	RO	M	RO
ifType	M	RO	M	RO
ifMtu	M	RO	M	RO
ifSpeed	M	RO	M	RO
ifPhysAddress	M	RO	M	RO
ifAdminStatus	M	RO	M	RO
ifOperStatus	M	RO	M	RO
ifLastChange	M	RO	M	RO
ifInOctets	M	RO	M	RO
ifInUcastPkts	M	RO	M	RO
ifInNUcastPkts	M	RO	M	RO
ifInDiscards	M	RO	M	RO
ifInErrors	M	RO	M	RO
ifInUnknownProtos	M	RO	M	RO
ifOutOctets	M	RO	M	RO
ifOutUcastPkts	M	RO	M	RO
ifOutNUcastPkts	M	RO	M	RO

ifOutDiscards	M	RO	M	RO
ifOutErrors	M	RO	M	RO
ifOutQLen	M	RO	M	RO
ifSpecific	M	RO	M	RO
ifXTable				
Objects	M-CMTS EQAM	Access	VIDEO EQAM	Access
ifName	M	RO	M	RO
ifInMulticastPkts	M	RO	M	RO
ifInBroadcastPkts	M	RO	M	RO
ifOutMulticastPkts	M	RO	M	RO
ifOutBroadcastPkts	M	RO	M	RO
ifHCInOctets	M	RO	M	RO
ifHCInUcastPkts	M	RO	M	RO
ifHCInMulticastPkts	M	RO	M	RO
ifHCInBroadcastPkts	M	RO	M	RO
ifHCOctets	M	RO	M	RO
ifHCOUcastPkts	M	RO	M	RO
ifHCOMulticastPkts	M	RO	M	RO
ifHCOBroadcastPkts	M	RO	M	RO
ifLinkUpDownTrapEnable	M	RO	M	RO
ifHighSpeed	M	RO	M	RO
ifPromiscuousMode	M	RO	M	RO
ifConnectorPresent	M	RO	M	RO
ifAlias	M	RO	M	RO
ifCounterDiscontinuityTime	M	RO	M	RO
ifStackTable				
Objects	M-CMTS EQAM	Access	VIDEO EQAM	Access
ifStackHigherLayer	M	N-Acc	M	N-Acc
ifStackLowerLayer	M	N-Acc	M	N-Acc
ifStackStatus	M	RC/RO	M	RC/RO
ifMIBObjects				
Objects	M-CMTS EQAM	Access	VIDEO EQAM	Access
ifStackLastChange	M	RC/RO	M	RC/RO

snmpTraps				
Notification	M-CMETS EQAM	Access	VIDEO EQAM	Access
linkup	M		M	
linkDown	M		M	
ENTITY-MIB [RFC 4133]				
entPhysicalTable				
Objects	M-CMETS EQAM	Access	VIDEO EQAM	Access
entPhysicalIndex	M	N-Acc	M	N-Acc
entPhysicalDescr	M	RO	M	RO
entPhysicalVendorType	M	RO	M	RO
entPhysicalContainedIn	M	RO	M	RO
entPhysicalClass	M	RO	M	RO
entPhysicalParentRelPos	M	RO	M	RO
entPhysicalName	M	RO	M	RO
entPhysicalHardwareRev	M	RO	M	RO
entPhysicalFirmwareRev	M	RO	M	RO
entPhysicalSoftwareRev	M	RO	M	RO
entPhysicalSerialNum	M	RO	M	RO
entPhysicalMfgName	M	RO	M	RO
entPhysicalModelName	M	RO	M	RO
entPhysicalAlias	M	RO	M	RO
entPhysicalAssetID	M	RO	M	RO
entPhysicalIsFRU	M	RO	M	RO
entPhysicalMfgDate	M	RO	M	RO
entPhysicalUris	M	RO	M	RO
entAliasMappingTable				
Objects	M-CMETS EQAM	Access	VIDEO EQAM	Access
entAliasLogicalIndexOrZero	M	N-Acc	M	N-Acc
entAliasMappingIdentifier	M	RO	M	RO
entPhysicalContainsTable				
Object	M-CMETS EQAM	Access	VIDEO EQAM	Access
entPhysicalChildIndex	M	RO	M	RO

SNMPv2-MIB [RFC 3418]				
System Group				
Objects	M-CMITS EQAM	Access	VIDEO EQAM	Access
sysDescr	M	RO	M	RO
sysObjectID	M	RO	M	RO
sysUpTime	M	RO	M	RO
sysContact	M	RO	M	RO
sysName	M	RW	M	RW
sysLocation	M	RW	M	RW
sysServices	M	RO	M	RO
sysORLastChange	M	RO	M	RO
sysORTable				
Objects	M-CMITS EQAM	Access	VIDEO EQAM	Access
sysORIndex	M	N-Acc	M	N-Acc
sysORID	M	RO	M	RO
sysORDescr	M	RO	M	RO
sysORUpTime	M	RO	M	RO
SNMP Group				
Object	M-CMITS EQAM	Access	VIDEO EQAM	Access
snmpEnableAuthenTraps	M	RO	M	RO
IP-MIB [RFC 4293]				
ipSystemStatsTable				
Object	M-CMITS EQAM	Access	VIDEO EQAM	Access
ipSystemStatsIPVersion	O	N-Acc	O	N-Acc
ipSystemStatsInReceives	O	RO	O	RO
ipSystemStatsHCInReceives	O	RO	O	RO
ipSystemStatsInOctets	O	RO	O	RO
ipSystemStatsHCInOctets	O	RO	O	RO
ipSystemStatsInHdrErrors	O	RO	O	RO
ipSystemStatsInNoRoutes	O	RO	O	RO
ipSystemStatsInAddrErrors	O	RO	O	RO
ipSystemStatsInUnknownProtos	O	RO	O	RO
ipSystemStatsInTruncatedPkts	O	RO	O	RO
ipSystemStatsInForwDatagrams	O	RO	O	RO

ipSystemStatsHCInForwDatagrams	O	RO	O	RO
ipSystemStatsReasmReqds	O	RO	O	RO
ipSystemStatsReasmOKs	O	RO	O	RO
ipSystemStatsReasmFails	O	RO	O	RO
ipSystemStatsInDiscards	O	RO	O	RO
ipSystemStatsInDelivers	O	RO	O	RO
ipSystemStatsHCInDelivers	O	RO	O	RO
ipSystemStatsOutRequests	O	RO	O	RO
ipSystemStatsHCOutRequests	O	RO	O	RO
ipSystemStatsOutNoRoutes	O	RO	O	RO
ipSystemStatsOutForwDatagrams	O	RO	O	RO
ipSystemStatsHCOutForwDatagrams	O	RO	O	RO
ipSystemStatsOutDiscards	O	RO	O	RO
ipSystemStatsOutFragReqds	O	RO	O	RO
ipSystemStatsOutFragOKs	O	RO	O	RO
ipSystemStatsOutFragFails	O	RO	O	RO
ipSystemStatsOutFragCreates	O	RO	O	RO
ipSystemStatsOutTransmits	O	RO	O	RO
ipSystemStatsHCOutTransmits	O	RO	O	RO
ipSystemStatsOutOctets	O	RO	O	RO
ipSystemStatsHCOutOctets	O	RO	O	RO
ipSystemStatsInMcastPkts	O	RO	O	RO
ipSystemStatsInMcastOctets	O	RO	O	RO
ipSystemStatsHCInMcastOctets	O	RO	O	RO
ipSystemStatsOutMcastPkts	O	RO	O	RO
ipSystemStatsHCOutMcastPkts	O	RO	O	RO
ipSystemStatsOutMcastOctets	O	RO	O	RO
ipSystemStatsHCOutMcastOctets	O	RO	O	RO
ipSystemStatsInBcastPkts	O	RO	O	RO
ipSystemStatsHCInBcastPkts	O	RO	O	RO
ipSystemStatsOutBcastPkts	O	RO	O	RO
ipSystemStatsHCOutBcastPkts	O	RO	O	RO
ipSystemStatsDiscontinuityTime	O	RO	O	RO
ipSystemStatsRefreshRate	O	RO	O	RO
ipIfStatsEntry (Mandatory for management port only)				
Access	M-CMTS EQAM	Access	VIDEO EQAM	Access
ipIfStatsIPVersion	S	N-Acc	S	N-Acc

ipIfStatsIfIndex	S	N-Acc	S	N-Acc
ipIfStatsInReceives	S	RO	S	RO
ipIfStatsHCInReceives	O	RO	O	RO
ipIfStatsInOctets	O	RO	O	RO
ipIfStatsHCInOctets	O	RO	O	RO
ipIfStatsInHdrErrors	S	RO	S	RO
ipIfStatsInNoRoutes	O	RO	O	RO
ipIfStatsInAddrErrors	S	RO	S	RO
ipIfStatsInUnknownProtos	S	RO	S	RO
ipIfStatsInTruncatedPkts	O	RO	O	RO
ipIfStatsInForwDatagrams	S	RO	S	RO
ipIfStatsHCInForwDatagrams	O	RO	O	RO
ipIfStatsReasmReqds	S	RO	S	RO
ipIfStatsReasmOKs	S	RO	S	RO
ipIfStatsReasmFails	S	RO	S	RO
ipIfStatsInDiscards	S	RO	S	RO
ipIfStatsInDelivers	S	RO	S	RO
ipIfStatsHCInDelivers	O	RO	O	RO
ipIfStatsOutRequests	S	RO	S	RO
ipIfStatsHCOutRequests	O	RO	O	RO
ipIfStatsOutForwDatagrams	O	RO	O	RO
ipIfStatsHCOutForwDatagrams	O	RO	O	RO
ipIfStatsOutDiscards	S	RO	S	RO
ipIfStatsOutFragReqds	O	RO	O	RO
ipIfStatsOutFragOKs	S	RO	S	RO
ipIfStatsOutFragFails	S	RO	S	RO
ipIfStatsOutFragCreates	S	RO	S	RO
ipIfStatsOutTransmits	O	RO	O	RO
ipIfStatsHCOutTransmits	O	RO	O	RO
ipIfStatsOutOctets	O	RO	O	RO
ipIfStatsHCOutOctets	O	RO	O	RO
ipIfStatsInMcastPkts	S	RO	S	RO
ipIfStatsHCInMcastPkts	O	RO	O	RO
ipIfStatsInMcastOctets	O	RO	O	RO
ipIfStatsHCInMcastOctets	O	RO	O	RO
ipIfStatsOutMcastPkts	S	RO	S	RO
ipIfStatsHCOutMcastPkts	O	RO	O	RO

ipIfStatsOutMcastOctets	O	RO	O	RO
ipIfStatsHCOutMcastOctets	O	RO	O	RO
ipIfStatsInBcastPkts	S	RO	S	RO
ipIfStatsHCInBcastPkts	O	RO	O	RO
ipIfStatsOutBcastPkts	S	RO	S	RO
ipIfStatsHCOutBcastPkts	O	RO	O	RO
ipIfStatsDiscontinuityTime	S	RO	S	RO
ipIfStatsRefreshRate	S	RO	S	RO
ipAddressTable				
Access	M-CMTS EQAM	Access	VIDEO EQAM	Access
ipAddressAddrType	S	N-Acc	S	N-Acc
ipAddressAddr	S	N-Acc	S	N-Acc
ipAddressIfIndex	S	RC	S	RC
ipAddressType	S	RC	S	RC
ipAddressPrefix	S	RC	S	RC
ipAddressOrigin	S	RC	S	RC
ipAddressStatus	S	RC	S	RC
ipAddressCreated	S	RC	S	RC
ipAddressLastChanged	S	RC	S	RC
ipAddressRowStatus	S	RC	S	RC
ipAddressStorageType	S	RC	S	RC
ipNetToPhysicalTable				
Object	M-CMTS EQAM	Access	VIDEO EQAM	Access
ipNetToPhysicalIfIndex	S	N-Acc	S	N-Acc
ipNetToPhysicalNetAddressType	S	N-Acc	S	N-Acc
ipNetToPhysicalNetAddress	S	N-Acc	S	N-Acc
ipNetToPhysicalPhysAddress	S	RC	S	RC
ipNetToPhysicalLastUpdated	S	RC	S	RC
ipNetToPhysicalType	O	RC	O	RC
ipNetToPhysicalState	O	RC	O	RC
ipNetToPhysicalRowStatus	S	RC	S	RC

SNMP-VIEW-BASED-ACM-MIB [RFC 3415]				
vacmContextTable				
Object	M-CMTS EQAM	Access	VIDEO EQAM	Access
vacmContextName	O	RO	O	RO
vacmSecurityToGroupTable				
Objects	M-CMTS EQAM	Access	VIDEO EQAM	Access
vacmSecurityModel	O	N-Acc	O	N-Acc
vacmSecurityName	O	N-Acc	O	N-Acc
vacmGroupName	O	RC/RO	O	RC/RO
vacmSecurityToGroupStorageType	O	RC/RO	O	RC/RO
vacmSecurityToGroupStatus	O	RC/RO	O	RC/RO
vacmAccessTable				
Objects	M-CMTS EQAM	Access	VIDEO EQAM	Access
vacmAccessContextPrefix	O	N-Acc	O	N-Acc
vacmAccessSecurityModel	O	N-Acc	O	N-Acc
vacmAccessSecurityLevel	O	N-Acc	O	N-Acc
vacmAccessContextMatch	O	RC/RO	O	RC/RO
vacmAccessReadViewName	O	RC/RO	O	RC/RO
vacmAccessWriteViewName	O	RC/RO	O	RC/RO
vacmAccessNotifyViewName	O	RC/RO	O	RC/RO
vacmAccessStorageType	O	RC/RO	O	RC/RO
vacmAccessStatus	O	RC/RO	O	RC/RO
vacmViewSpinLock	O	RO	O	RO
vacmViewTreeFamilyTable				
Objects	M-CMTS EQAM	Access	VIDEO EQAM	Access
vacmViewTreeFamilyViewName	O	N-Acc	O	N-Acc
vacmViewTreeFamilySubtree	O	N-Acc	O	N-Acc
vacmViewTreeFamilyMask	O	RC/RO	O	RC/RO
vacmViewTreeFamilyType	O	RC/RO	O	RC/RO
vacmViewTreeFamilyStorageType	O	RC/RO	O	RC/RO
vacmViewTreeFamilyStatus	O	RC/RO	O	RC/RO

SNMP-COMMUNITY-MIB [RFC 3584]				
snmpCommunityTable				
Objects	M-CMTS EQAM	Access	VIDEO EQAM	Access
snmpCommunityIndex	O	N-Acc	O	N-Acc
snmpCommunityName	O	RC/RO	O	RC/RO
snmpCommunitySecurityName	O	RC/RO	O	RC/RO
snmpCommunityContextEngineID	O	RC/RO	O	RC/RO
snmpCommunityContextName	O	RC/RO	O	RC/RO
snmpCommunityTransportTag	O	RC/RO	O	RC/RO
snmpCommunityStorageType	O	RC/RO	O	RC/RO
snmpCommunityStatus	O	RC/RO	O	RC/RO
snmpTargetExtTable				
Objects	M-CMTS EQAM	Access	VIDEO EQAM	Access
snmpTargetAddrTMask	O	RC/RO	O	RC/RO
snmpTargetAddrMMS	O	RC/RO	O	RC/RO
snmpTrapAddress	O	ACC-FN	O	ACC-FN
snmpTrapCommunity	O	ACC-FN	O	ACC-FN
SNMP Management Framework Architecture [RFC 3411]				
snmpEngine Group				
Objects	M-CMTS EQAM	Access	VIDEO EQAM	Access
snmpEngineID	O	RO	O	RO
snmpEngineBoots	O	RO	O	RO
snmpEngineTime	O	RO	O	RO
snmpEngineMaxMessageSize	O	RO	O	RO
SNMP Message Processing and Dispatching MIB [RFC 3412]				
snmpMPDStats				
Objects	M-CMTS EQAM	Access	VIDEO EQAM	Access
snmpUnknownSecurityModels	O	RO	O	RO
snmpInvalidMsgs	O	RO	O	RO
snmpUnknownPDUHandlers	O	RO	O	RO
SNMP Applications [RFC 3413]				
Objects	M-CMTS EQAM	Access	VIDEO EQAM	Access
snmpTargetSpinLock	O	RO	O	RO

snmpTargetAddrTable				
Objects	M-CMTS EQAM	Access	VIDEO EQAM	Access
snmpTargetAddrName	O	N-Acc	O	N-Acc
snmpTargetAddrTDomain	O	RC/RO	O	RC/RO
snmpTargetAddrTAddress	O	RC/RO	O	RC/RO
snmpTargetAddrTimeout	O	RC/RO	O	RC/RO
snmpTargetAddrRetryCount	O	RC/RO	O	RC/RO
snmpTargetAddrTagList	O	RC/RO	O	RC/RO
snmpTargetAddrParams	O	RC/RO	O	RC/RO
snmpTargetAddrStorageType	O	RC/RO	O	RC/RO
snmpTargetAddrRowStatus	O	RC/RO	O	RC/RO
snmpTargetParamsTable				
Objects	M-CMTS EQAM	Access	VIDEO EQAM	Access
snmpTargetParamsName	O	N-Acc	O	N-Acc
snmpTargetParamsMPModel	O	RC/RO	O	RC/RO
snmpTargetParamsSecurityModel	O	RC/RO	O	RC/RO
snmpTargetParamsSecurityName	O	RC/RO	O	RC/RO
snmpTargetParamsSecurityLevel	O	RC/RO	O	RC/RO
snmpTargetParamsStorageType	O	RC/RO	O	RC/RO
snmpTargetParamsRowStatus	O	RC/RO	O	RC/RO
snmpUnavailableContexts	O	RC/RO	O	RC/RO
snmpUnknownContexts	O	RC/RO	O	RC/RO
snmpNotifyTable				
Objects	M-CMTS EQAM	Access	VIDEO EQAM	Access
snmpNotifyName	O	N-Acc	O	N-Acc
snmpNotifyTag	O	RC/RO	O	RC/RO
snmpNotifyType	O	RC/RO	O	RC/RO
snmpNotifyStorageType	O	RC/RO	O	RC/RO
snmpNotifyRowStatus	O	RC/RO	O	RC/RO
snmpNotifyFilterProfileTable				
Objects	M-CMTS EQAM	Access	VIDEO EQAM	Access
snmpNotifyFilterProfileName	O	RC/RO	O	RC/RO
snmpNotifyFilterProfileStorType	O	RC/RO	O	RC/RO
snmpNotifyFilterProfileRowStatus	O	RC/RO	O	RC/RO

snmpNotifyFilterTable				
Objects	M-CMITS EQAM	Access	VIDEO EQAM	Access
snmpNotifyFilterSubtree	O	N-Acc	O	N-Acc
snmpNotifyFilterMask	O	RC/RO	O	RC/RO
snmpNotifyFilterType	O	RC/RO	O	RC/RO
snmpNotifyFilterStorageType	O	RC/RO	O	RC/RO
snmpNotifyFilterRowStatus	O	RC/RO	O	RC/RO
SNMP-USER-BASED-SM-MIB [RFC 3414]				
usmStats				
Objects	M-CMITS EQAM	Access	VIDEO EQAM	Access
usmStatsUnsupportedSecLevels	O	RO	O	RO
usmStatsNotInTimeWindows	O	RO	O	RO
usmStatsUnknownUserNames	O	RO	O	RO
usmStatsUnknownEngineIDs	O	RO	O	RO
usmStatsWrongDigests	O	RO	O	RO
usmStatsDecryptionErrors	O	RO	O	RO
usmUser				
Object	M-CMITS EQAM	Access	VIDEO EQAM	Access
usmUserSpinLock	O	RO	O	RO
usmUserTable				
Objects	M-CMITS EQAM	Access	VIDEO EQAM	Access
usmUserEngineID	O	N-Acc	O	N-Acc
usmUserName	O	N-Acc	O	N-Acc
usmUserSecurityName	O	RC/RO	O	RC/RO
usmUserCloneFrom	O	RC/RO	O	RC/RO
usmUserAuthProtocol	O	RC/RO	O	RC/RO
usmUserAuthKeyChange	O	RC/RO	O	RC/RO
usmUserOwnAuthKeyChange	O	RC/RO	O	RC/RO
usmUserPrivProtocol	O	RC/RO	O	RC/RO
usmUserPrivKeyChange	O	RC/RO	O	RC/RO
usmUserOwnPrivKeyChange	O	RC/RO	O	RC/RO
usmUserPublic	O	RC/RO	O	RC/RO
usmUserStorageType	O	RC/RO	O	RC/RO
DOCS-EQAM-MIB Annex C				
docsEQamControl				

Object	M-CMTS EQAM	Access	VIDEO EQAM	Access
docsEQamControlReset	M	RO	M	RO
docsEQamControlInitCause	M	RO	M	RO
docsEQamControlSaveCfg	M	RO	M	RO
docsEQamControlUploadCfg	M	RO	M	RO
docsEQamNMSAccessTable				
Object	M-CMTS EQAM	Access	VIDEO EQAM	Access
docsEQamNMSAccessTable	N-Sup		N-Sup	
docsEQamNMSAccessEntry	N-Sup		N-Sup	
docsEQamNMSAccessIndex	N-Sup		N-Sup	
docsEQamNMSAccessIpAddress	N-Sup		N-Sup	
docsEQamNMSAccessIpAddressPrefix	N-Sup		N-Sup	
docsEQamNMSAccessControl	N-Sup		N-Sup	
docsEQamNMSAccessNotifVersion	N-Sup		N-Sup	
docsEQamNMSAccessCommunityString	N-Sup		N-Sup	
docsEQamNMSAccessRowStatus	N-Sup		N-Sup	
docsEQamTime				
Object	M-CMTS EQAM	Access	VIDEO EQAM	Access
docsEQamTimeNtpMaster	M	RO	M	RO
docsEQamTimeNtpBackup	M	RO	M	RO
docsEQamTimeTimeZone	M	RO	M	RO
docsEQamTimeDaylightSaving	M	RO	M	RO
docsEQamSyslogServerTable				
Object	M-CMTS EQAM	Access	VIDEO EQAM	Access
docsEQamSyslogServerTable	M	N-Acc	M	N-Acc
docsEQamSyslogServerEntry	M	N-Acc	M	N-Acc
docsEQamSyslogServerIndex	M	N-Acc	M	N-Acc
docsEQamSyslogServer	M	RO	M	RO
docsEQamSyslogServerInetAddressType	M	RO	M	RO
docsEQamSyslogServerInetAddress	M	RO	M	RO
docsEQamSyslogServerEnabled	M	RO	M	RO
docsEQamSyslogServerRowStatus	N-Sup		N-Sup	
docsEQamRegistrationTable				

Object	M-CMTS EQAM	Access	VIDEO EQAM	Access
docsEQamRegistrationTable	M	N-Acc	M	N-Acc
docsEQamRegistrationEntry	M	N-Acc	M	N-Acc
docsEQamRegistrationErmName	M	N-Acc	M	N-Acc
docsEQamRegistrationErmAddressType	M	RO	M	RO
docsEQamRegistrationErmAddress	M	RO	M	RO
docsEQamRegistrationErmPort	M	RO	M	RO
docsEQamRegistrationErmConnectionType	M	RO	M	RO
docsEQamRegistrationHoldTimer	M	RO	M	RO
docsEQamRegistrationConnRetryTimer	M	RO	M	RO
docsEQamRegistrationNextHopAddressDomain	M	RO	M	RO
docsEQamRegistrationCompAddress	M	RO	M	RO
docsEQamRegistrationStreamingZone	M	RO	M	RO
docsEQamRegistrationId	M	RO	M	RO
docsEQamRegistrationCost	M	RO	M	RO
docsEQamRegistrationCompName	M	RO	M	RO
docsEQamRegistrationRowStatus	N-Sup		N-Sup	
docsEQamTSInputCfg				
Object	M-CMTS EQAM	Access	VIDEO EQAM	Access
docsEQamTSInputCfgUnicastSessionLossTimeout	M	RO	M	RO
docsEQamTSInputCfgMulticastSessionLossTimeout	M	RO	M	RO
docsEQamTSInputCfgJitterTolerance	M	RO	M	RO
docsEQamTSOutputCfg				
Object	M-CMTS EQAM	Access	VIDEO EQAM	Access
docsEQamTSOutputCfgCatInsertRate	M	RO	M	RO
docsEQamTSOutputCfgPatInsertRate	M	RO	M	RO
docsEQamTSOutputCfgPmtInsertRate	M	RO	M	RO
docsEQamReservedUdpTable				
Object	M-CMTS EQAM	Access	VIDEO EQAM	Access
docsEQamReservedUdpTable	M	N-Acc	M	N-Acc
docsEQamReservedUdpEntry	M	N-Acc	M	N-Acc
docsEQamReservedUdpMapIndex	M	N-Acc	M	N-Acc
docsEQamReservedUdpMapStartingPort	M	RO	M	RO
docsEQamReservedUdpMapCount	M	RO	M	RO
docsEQamReservedUdpMap	N-Sup		N-Sup	

docsEQamReservedPidRangeTable				
Object	M-CMTS EQAM	Access	VIDEO EQAM	Access
docsEQamReservedPidRangeTable	M	N-Acc	M	N-Acc
docsEQamReservedPidRangeEntry	M	N-Acc	M	N-Acc
docsEQamReservedPidRangeIndex	M	N-Acc	M	N-Acc
docsEQamReservedPidRangeStartingPid	M	RO	M	RO
docsEQamReservedPidRangeCount	M	RO	M	RO
docsEQamReservedPidRangeDescription	M	RO	M	RO
docsEQamReservedPidRangeRowStatus	N-Sup		N-Sup	
docsEQamEdgeInputTable				
Object	M-CMTS EQAM	Access	VIDEO EQAM	Access
docsEQamEdgeInputTable	M	N-Acc	M	N-Acc
docsEQamEdgeInputEntry	M	N-Acc	M	N-Acc
docsEQamEdgeInputName	M	N-Acc	M	N-Acc
docsEQamEdgeInputIpAddressType	M	RO	M	RO
docsEQamEdgeInputIpAddress	M	RO	M	RO
docsEQamInputRegistrationTable				
Object	M-CMTS EQAM	Access	VIDEO EQAM	Access
docsEQamInputRegistrationTable	M	N-Acc	M	N-Acc
docsEQamInputRegistrationEntry	M	N-Acc	M	N-Acc
docsEQamInputRegistrationGroupName	M	RO	M	RO
docsEQamInputRegistrationBandwidth	M	RO	M	RO
docsEQamInputRegistrationErmName	M	RO	M	RO
docsEQamInputRegistrationRowStatus	N-Sup		N-Sup	
docsEQamRFPortTable				
Object	M-CMTS EQAM	Access	VIDEO EQAM	Access
docsEQamRFPortTable	M	N-Acc	M	N-Acc
docsEQamRFPortEntry	M	N-Acc	M	N-Acc
docsEQamRFPortName	M	N-Acc	M	N-Acc
docsEQamRFPortAdminStatus	M	RO	M	RO
docsEQamRFPortPower	M	RO	M	RO
docsEQamRFPortFrequency	M	RO	M	RO
docsEQamRFPortModulation	M	RO	M	RO
docsEQamRFPortInterleaverMode	M	RO	M	RO

docsEQamRFPortInterleaveLevel	M	RO	M	RO
docsEQamRFPortAnnex	M	RO	M	RO
docsEQamRFPortSpectrumInversion	M	RO	M	RO
docsEQamRFPortLockParameters	M	RO	M	RO
docsEQamRFPortcfgNumberChannels	M	RO	M	RO
docsEQamRFPortNumberChannels	M	RO	M	RO
docsEQamRFPortLockRowStatus	N-Sup		N-Sup	
docsEQamFiberNodeTable				
Object	M-CMTS EQAM	Access	VIDEO EQAM	Access
docsEQamFiberNodeTable	M	N-Acc	M	N-Acc
docsEQamFiberNodeEntry	M	N-Acc	M	N-Acc
docsEQamFiberNodeName	M	RO	M	RO
docsEQamFiberNodeRowStatus	N-Sup		N-Sup	
docsEQamChannelTable				
Object	M-CMTS EQAM	Access	VIDEO EQAM	Access
docsEQamChannelTable	M	N-Acc	M	N-Acc
docsEQamChannelEntry	M	N-Acc	M	N-Acc
docsEQamChannelPhysName	M	N-Acc	M	N-Acc
docsEQamChannelRFPortPhysName	M	RO	M	RO
docsEQamChannelAdminStatus	M	RO	M	RO
docsEQamChannelPower	M	RO	M	RO
docsEQamChannelFrequency	M	RO	M	RO
docsEQamChannelModulation	M	RO	M	RO
docsEQamChannelInterleaverMode	M	RO	M	RO
docsEQamChannelInterleaverLevel	M	RO	M	RO
docsEQamChannelAnnex	M	RO	M	RO
docsEQamChannelSpectrumInversion	M	RO	M	RO
docsEQamChannelName	M	RO	M	RO
docsEQamChannelGroupName	M	RO	M	RO
docsEQamChannelErmName	M	RO	M	RO
docsEQamChannelLockParameters	M	RO	M	RO
docsEQamChannelAllocationType	M	RO	M	RO
docsEQamChannelERRPAdvertizing	M	RO	M	RO
docsEQamChannelDepiUdpPortMapping	M	RO	M	RO
docsEQamChannelRowStatus	N-Sup		N-Sup	
docsEQamDEPICfg				

Object	M-CMTS EQAM	Access	VIDEO EQAM	Access
docsEQamDEPICfgDepsSessionLossTO	M	RO	M	RO
docsEQamTSOutput				
Object	M-CMTS EQAM	Access	VIDEO EQAM	Access
docsEQamTSOutputTSID	M	RO	M	RO
docsEQamTSOutputNitPid	M	RO	M	RO
docsEQamTSOutputCaPid	M	RO	M	RO
docsEQamSessionLogCtr				
Object	M-CMTS EQAM	Access	VIDEO EQAM	Access
docsEQamSessionLogCtrlMaxSize	M	RO	M	RO
docsEQamSessionLogCtrlCurrentSize	M	RO	M	RO
docsEQamSessionLogCtrlAging	M	RO	M	RO
docsEQamSessionLogCtrlClearAll	M	RO	M	RO
docsEQamSessionLogCtrlType	M	RO	M	RO
docsEQamSessionLogTable				
Object	M-CMTS EQAM	Access	VIDEO EQAM	Access
docsEQamSessionLogTable	M	N-Acc	M	N-Acc
docsEQamSessionLogEntry	M	N-Acc	M	N-Acc
docsEQamSessionLogIndex	M	N-Acc	M	N-Acc
docsEQamSessionLogId	M	RO	M	RO
docsEQamSessionLogInputIfIndex	M	RO	M	RO
docsEQamSessionLogOutputIfIndex	M	RO	M	RO
docsEQamSessionLogInputContinuityErrors	M	RO	M	RO
docsEQamSessionLogInputSyncLossPkts	M	RO	M	RO
docsEQamSessionLogOutputTotalPkts	M	RO	M	RO
docsEQamSessionLogOutputDroppedPkts	M	RO	M	RO
docsEQamSessionLogOutputFifoOverflow	M	RO	M	RO
docsEQamSessionLogOutputFifoUnderflow	M	RO	M	RO
docsEQamSessionLogMode	M	RO	M	RO
docsEQamSessionLogStartTime	M	RO	M	RO
docsEQamSessionLogStopTime	M	RO	M	RO
docsEQamSessionLogInputAddrType	M	RO	M	RO
docsEQamSessionLogInputSrcInetAddr	M	RO	M	RO
docsEQamSessionLogInputSrcPort	M	RO	M	RO
docsEQamSessionLogInputDstInetAddr	M	RO	M	RO

docsEQamSessionLogInputDstPort	M	RO	M	RO
docsEQamNotify				
Object	M-CMSTS EQAM	Access	VIDEO EQAM	Access
docsEQamNotify	M	Notif	M	Notif
docsDevEvLevel	M	Notif	M	Notif
docsDevEvId	M	Notif	M	Notif
docsDevEvText	M	Notif	M	Notif
HostName	M	Notif	M	Notif
MgmtInetAddressType	M	Notif	M	Notif
MgmtInetAddress	M	Notif	M	Notif

A.2 IF-MIB ifTable MIB-Object details

Table A-4 - IF-MIB ifTable MIB-Object details

IF-MIB Object details for Cable Device using 1000 Mbps Ethernet	CMTS-Downstream M-CMSTS Core, M-CMSTS EQAM	EQAM GigE	DTI/ M-CMSTS/ EQAM Client
ifIndex	(n)	(n)	(n)
ifType	229	6	other(1)
ifSpeed	~64-QAM=30,341,646 ~256-QAM=42,884,296	1000,000,000	5,000,000
ifHighSpeed	~64-QAM=30 ~256-QAM=42	1000	5
ifPhysAddress	Empty-String	Eth MAC	Empty-String
ifAdminStatus	Up(1), Down(2), Testing(3)	Up(1), Down(2), Testing(3)	Up(1), Down(2), Testing(3)
ifOperStatus	Up(1), Down(2), Testing(3), Dormant(5), notPresent(6)	Up(1), Down(2), Testing(3), Dormant(5), notPresent(6)	Up(1), Down(2), Testing(3), Dormant(5), notPresent(6)
ifMtu	1464, (n)	1500, (n)	256
ifInOctets	0	(n)	(n)
ifHCInOctets	0	(n)	(n)
ifOutOctets	(n)	(n)	(n)
ifHCOctets	(n)	(n)	(n)
ifInUcastPkts	0	(n)	(n)
ifHCInUcastPkts	0	(n)	(n)
ifInMulticastPkts	0	(n)	(n)
ifHCInMulticastPkts	0	(n)	(n)
ifInBroadcastPkts	0	(n)	(n)
ifHCInBroadcastPkts	0	(n)	(n)
ifInDiscards	0	(n)	(n)

IF-MIB Object details for Cable Device using 1000 Mbps Ethernet	CMTS-Downstream M-CMTS Core, M-CMTS EQAM	EQAM GigE	DTI/ M-CMTS/ EQAM Client
ifInErrors	0	(n)	(n)
ifInUnknownProtos	0	(n)	(n)
ifOutUcastPkts	(n)	(n)	(n)
ifHCOUcastPkts	(n)	(n)	(n)
ifOutMulticastPkts	(n)	(n)	(n)
ifHCOmulticastPkts	(n)	(n)	(n)
ifOutBroadcastPkts	(n)	(n)	(n)
ifHCObroadcastPkts	(n)	(n)	(n)
ifOutDiscards	(n)	(n)	(n)
ifOutErrors	(n)	(n)	(n)
ifPromiscuousMode	True(1), false(2)	True(1), false(2)	True(1), false(2)

Annex B Description of the XML based configuration file

The following section describes the XML configuration file elements and attributes. When it's applicable, the attribute name and value match the one referenced in the specified MIB. Figure B-1 represents the QAM config file object Model with the elements definitions thereafter. The corresponding XML schemas definitions are in Section B.2.

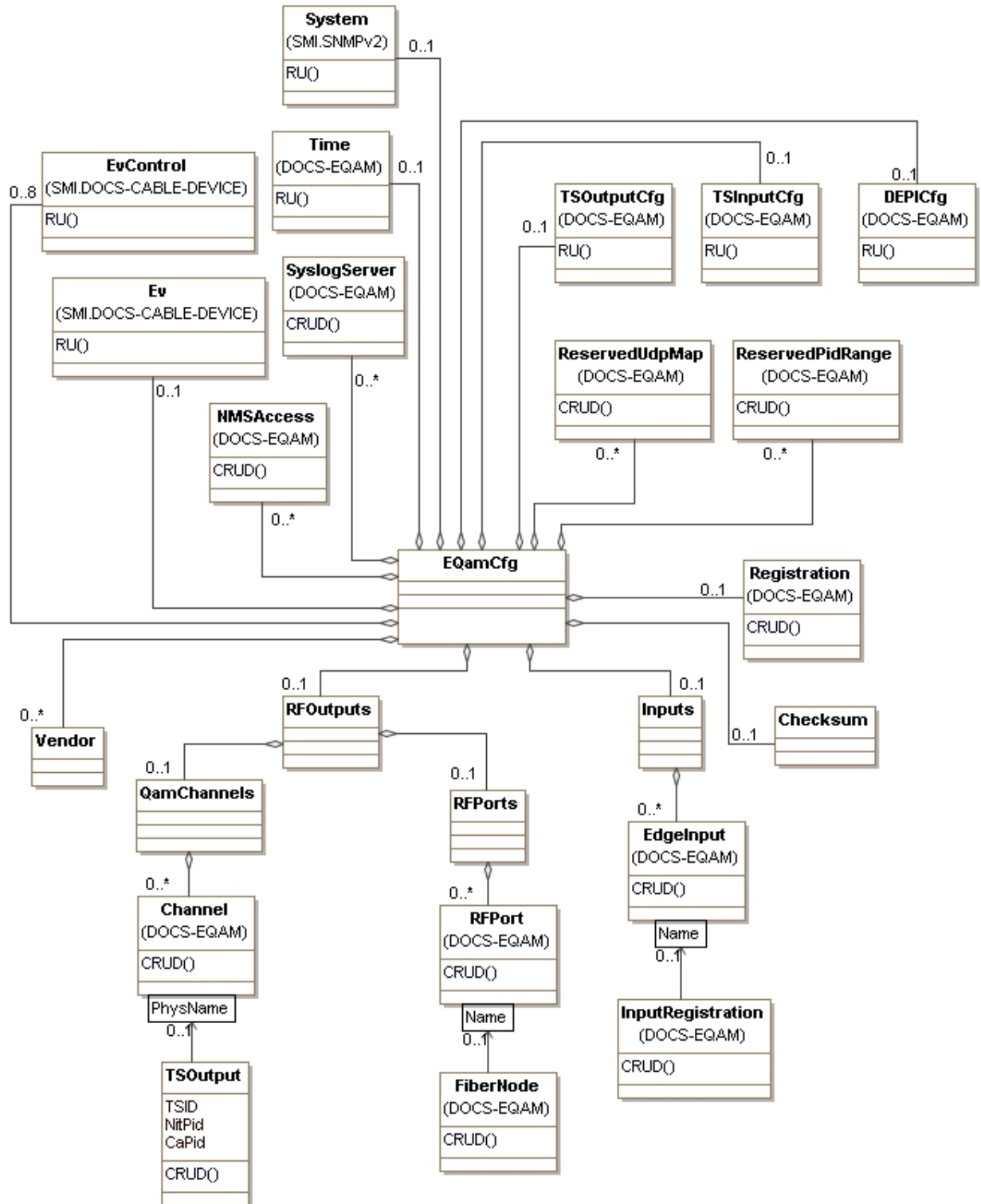

Figure B-1 - XML Configuration Object Model

B.1 EqamCfg

Below is the description of the XML config file elements.

Annex B.2 contains the XML Schema definition of the config file structure defined in this section. Note that the majority of the definitions of this XML config file come from the EQAM object model defined in Annex C. Also, since this XML config file has the purpose of writing the EQAM configuration, any read-only element referenced from Annex C or any other source is skipped in the schema definition.

Whenever the schema references object from SNMP Modules, the following rules apply:

- SNMP RowStatus is not added as part of the XML elements and attributes
- SNMP Extension tables become children elements of the parent table.
- InetAddressType elements are not included in the XML schema.

Table B-1 - EQamCfg Config File elements

Element Name	Multiplicity	Description
System	0..1	EQAM identification
NMSAccess	0..*	Network Management System SNMP Access Control See NMSAccess Object in Annex C.
Time	0..1	EQAM time setting See Time Object in Annex C.
SyslogServer	0..*	SysLog Server information See SyslogServer Object in Annex C.
Ev	0..1	Control event logging rates. Corresponds to the scalar set of objects under the object identifier docsDevEvent of [RFC 4639].
EvControl	0..*	Event destination control Corresponds to the table docsDevEvControlTable of [RFC 4639].
Registration	1..*	Registration with the Edge Resource Manager (ERM). See Registration Object in Annex C.
TSInputCfg	0..1	Global input TS parameters See TSInputCfg Object in Annex C.
TSOuputCfg	0..1	Global output TS parameters See TSOuputCfg Object in Annex C.
ReservedUdpMap	0..*	Reserved PID Ranges See ReservedUdpMap Object in Annex C.
ReservedPidRange	0..*	Reserved PID Ranges See ReservedPidRange Object in Annex C.
Inputs	0..1	Describes the inputs for the EQAM.
RFOuputs	0..1	Describes the outputs for the EQAM. See NMSAccess Object in Annex C.
Vendor	0..*	Vendor-specific extensions
Checksum	0..1	XML file checksum Config File integrity check.

B.1.1 System

This object represents the EQAM general information.

- Object Operations:
None

Table B-2 - System Object

Attribute Name	Type	Access	Type Constraints	Units	Default
sysName	AdminString	CRUD			
sysContact	AdminString	CRUD			
sysLocation	AdminString	CRUD			

- sysContact
The contact person according to [RFC 3418].
- sysName
The system name according to [RFC 3418].
- sysLocation
The system location according to [RFC 3418].

B.1.2 Inputs

Elements:

Table B-3 - Inputs elements

Name	Multiplicity	Description
EdgeInputs	0..1	Configuration of input Interfaces See EdgeInputs Object in Annex C.

B.1.2.1 EdgeInputs

Elements:

Table B-4 - EdgeInputs elements

Name	Multiplicity	Description
InputRegistration	0..1	Configuration of input Interfaces Resource Management parameters. See InputRegistration Object in Annex C.

B.1.3 RFOutputs

Elements:

Table B-5 - RFOutputs elements

Name	Multiplicity	Description
RFPorts	0..1	Configuration of RF output ports
QamChannels	0..1	Configuration of QAM channels

B.1.3.1 RFPorts**Elements:***Table B-6 - RFPorts elements*

Name	Multiplicity	Description
RFPort	0..*	Configuration of an RF output port See RFPort Object in Annex C.

*B.1.3.1.1 RfPort***Elements:***Table B-7 - RFPort elements*

Name	Multiplicity	Description
FiberNode	0..*	Configuration of Fiber Nodes connected to the RF Ports See FiberNode Object in Annex C.

B.1.3.2 QamChannels**Elements:***Table B-8 - QamChannels elements*

Name	Multiplicity	Description
Channel	0..*	QAM channel Configuration See Channel Object in Annex C.

*B.1.3.2.1 Channel***Elements:***Table B-9 - Channel elements*

Name	Multiplicity	Description
StaticUdpMap	0..*	Static Mapping of UDP ports for the QAM Channel See StaticUdpMap Object in Annex C.
TsOutput	0..1	OutgoingTransport Stream configuration parameters for the QAM Channel See TsOutput in Annex C.

B.1.4 Vendor Object

This object represent the vendor specific extension for the QAM config file.

- Object Operations:
None

Table B-10 - Vendor Object

Attribute Name	Type	Access	Type Constraints	Units	Default
Id	unsignedInt	RU			

- Id

This attribute Indicates the value of the private enterprise number (PEN) assigned by IANA.

B.1.5 Checksum Object

This object represent the checksum information about the config file.

- Object Operations:
None

Table B-11 - Checksum Object

Attribute Name	Type	Access	Type Constraints	Units	Default
Type	Enum	RU	crc32(1)		
Value	hexBinary	RU			

- Type
This attribute Indicates the Checksum type and version of the value contained in the attribute 'Value'.
The value 'crc32' indicates a CRC-32 checksum.
- Value
This attribute corresponds to the [SHA-1] Checksum applied to the entire config file.

B.2 Configuration File XML Schema Definition

B.2.1 EQAM-CFG_1.0.XSD

```
<?xml version="1.0"?>
<schema targetNamespace="urn:cablelabs:namespaces:docsis:mha:xsd:EQAM-CFG:1.0"
  xmlns:this="urn:cablelabs:namespaces:docsis:mha:xsd:EQAM-CFG:1.0"
  xmlns="http://www.w3.org/2001/XMLSchema"
  xmlns:DOCS-EQAM="urn:cablelabs:namespaces:docsis:mha:xsd:EQAM:1.0"
  xmlns:DOCS-CABLE-DEVICE="urn:cablelabs:namespaces:smi:xsd:DOCS-CABLE-DEVICE:RFC4639"
  xmlns:SNMPv2="urn:cablelabs:namespaces:smi:xsd:SNMPv2:RFC3418"
  elementFormDefault="qualified">
  <import namespace="urn:cablelabs:namespaces:docsis:mha:xsd:EQAM:1.0"
    schemaLocation="http://www.cablelabs.com/namespaces/docsis/hma/xsd/EQAM_1.0.XSD"/>
  <import namespace="urn:cablelabs:namespaces:smi:xsd:DOCS-CABLE-DEVICE:RFC4639"
    schemaLocation="http://www.cablelabs.com/namespaces/smi/xsd/DOCS-CABLE-DEVICE_RFC4639.XSD"/>
  <import namespace="urn:cablelabs:namespaces:smi:xsd:SNMPv2:RFC3418"
    schemaLocation="http://www.cablelabs.com/namespaces/smi/SNMPv2_RFC3418.XSD"/>
  <complexType name="EQamCfg">
    <sequence>
      <element ref="DOCS-EQAM:NMSAccess" minOccurs="0" maxOccurs="unbounded"/>
      <element ref="SNMPv2:System" minOccurs="0"/>
      <element ref="DOCS-EQAM:Registration" minOccurs="0"/>
      <element ref="DOCS-EQAM:Time" minOccurs="0"/>
      <element ref="DOCS-EQAM:SessionLogCtrl" minOccurs="0"/>
      <element ref="this:Vendor" minOccurs="0" maxOccurs="unbounded"/>
      <element ref="this:Inputs" minOccurs="0"/>
      <element ref="this:RFOutputs" minOccurs="0"/>
      <element ref="DOCS-CABLE-DEVICE:Ev" minOccurs="0"/>
      <element ref="DOCS-CABLE-DEVICE:EvControl" minOccurs="0" maxOccurs="8"/>
      <element ref="DOCS-EQAM:SyslogServer" minOccurs="0" maxOccurs="unbounded"/>
      <element ref="DOCS-EQAM:TSPOutputCfg" minOccurs="0"/>
    </sequence>
  </complexType>
</schema>
```



```

        <element ref="DOCS-EQAM:TSInputCfg" minOccurs="0"/>
        <element ref="DOCS-EQAM:ReservedUdpMap" minOccurs="0" maxOccurs="unbounded"/>
        <element ref="DOCS-EQAM:ReservedPidRange" minOccurs="0" maxOccurs="unbounded"/>
        <element ref="DOCS-EQAM:DEPICfg" minOccurs="0"/>
        <element ref="this:Checksum" minOccurs="0"/>
    </sequence>
</complexType>
<element name="EQamCfg" type="this:EQamCfg"/>

<complexType name="Vendor">
    <sequence/>
    <attribute name="Id" type="unsignedInt" use="required"/>
</complexType>
<element name="Vendor" type="this:Vendor"/>

<complexType name="Inputs">
    <sequence>
        <element ref="DOCS-EQAM:EdgeInput" minOccurs="0" maxOccurs="unbounded"/>
    </sequence>
</complexType>
<element name="Inputs" type="this:Inputs"/>

<complexType name="RFOutputs">
    <sequence>
        <element ref="this:RFPorts" minOccurs="0"/>
        <element ref="this:QamChannels" minOccurs="0"/>
    </sequence>
</complexType>
<element name="RFOutputs" type="this:RFOutputs"/>

<complexType name="QamChannels">
    <sequence>
        <element ref="DOCS-EQAM:Channel" minOccurs="0" maxOccurs="unbounded"/>
    </sequence>
</complexType>
<element name="QamChannels" type="this:QamChannels"/>
<complexType name="RFPorts">
    <sequence>
        <element ref="DOCS-EQAM:RFPort" minOccurs="0" maxOccurs="unbounded"/>
    </sequence>
</complexType>
<element name="RFPorts" type="this:RFPorts"/>

<complexType name="Checksum">
    <sequence/>
    <attribute name="Type" type="int" use="required"/>
    <attribute name="Value" type="hexBinary" use="required"/>
</complexType>
<element name="Checksum" type="this:Checksum"/>
</schema>

```

B.2.2 EQAM_1.0.XSD

```

<?xml version="1.0"?>
<schema
    targetNamespace="urn:cablelabs:namespaces:docsis:mha:xsd:EQAM:1.0"
    xmlns:this="urn:cablelabs:namespaces:docsis:mha:xsd:EQAM:1.0"
    xmlns="http://www.w3.org/2001/XMLSchema"
    elementFormDefault="qualified">
    <complexType name="Control">
        <attribute name="Reset" type="boolean" use="optional" default="false"/>
        <attribute name="InitCause" use="optional" default="none">

```

```

        <simpleType>
            <restriction base="string">
                <enumeration value="nms"/>
                <enumeration value="none"/>
                <enumeration value="unknown"/>
            </restriction>
        </simpleType>
    </attribute>
    <attribute name="SaveCfg" type="string" use="optional" default=""/>
    <attribute name="UploadCfg" type="string" use="optional" default=""/>
</complexType>
<element name="Control" type="this:Control"/>

<complexType name="Notify">
    <attribute name="docsDevEvLevel" type="unsignedInt" use="optional"/>
    <attribute name="docsDevEvId" type="unsignedInt" use="optional"/>
    <attribute name="docsDevEvText" type="string" use="optional"/>
    <attribute name="HostName" type="string" use="optional"/>
    <attribute name="MgmtInetAddressType" type="this:InetAddressType" use="optional"/>
    <attribute name="MgmtInetAddress" type="string" use="optional"/>
</complexType>
<element name="Notify" type="this:Notify"/>

<complexType name="SessionLogCtrl">
    <attribute name="MaxSize" type="unsignedInt" use="optional" default="100"/>
    <attribute name="CurrentSize" type="unsignedInt" use="optional"/>
    <attribute name="Aging" type="unsignedInt" use="optional" default="10080"/>
    <attribute name="ClearAll" type="boolean" use="optional" default="false"/>
    <attribute name="Type" use="optional" default="sessionsWithExceptions">
        <simpleType>
            <restriction base="string">
                <enumeration value="allSessions"/>
                <enumeration value="sessionsWithExceptions"/>
            </restriction>
        </simpleType>
    </attribute>
</complexType>
<element name="SessionLogCtrl" type="this:SessionLogCtrl"/>

<complexType name="NMSAccess">
    <attribute name="Index" type="unsignedInt" use="optional"/>
    <attribute name="IpAddressType" type="this:InetAddressType" use="optional"/>
    <attribute name="IpAddress" type="hexBinary" use="optional"/>
    <attribute name="IpAddressPrefix" type="unsignedInt" use="optional" default="0"/>
    <attribute name="Control" use="optional" default="readOnly">
        <simpleType>
            <restriction base="string">
                <enumeration value="readOnly"/>
                <enumeration value="readWrite"/>
                <enumeration value="roWithNotif"/>
                <enumeration value="rwWithNotif"/>
                <enumeration value="notifOnly"/>
            </restriction>
        </simpleType>
    </attribute>
    <attribute name="NotifVersion" use="optional" default="trapV2c">
        <simpleType>
            <restriction base="string">
                <enumeration value="trapV1"/>
                <enumeration value="trapV2c"/>
                <enumeration value="Inform"/>
            </restriction>
        </simpleType>
    </attribute>

```

```

        </simpleType>
      </attribute>
      <attribute name="CommunityString" type="string" use="optional"/>
    </complexType>
  <element name="NMSAccess" type="this:NMSAccess"/>

  <complexType name="Time">
    <attribute name="NtpMaster" type="hexBinary" use="optional"/>
    <attribute name="NtpBackup" type="hexBinary" use="optional"/>
    <attribute name="TimeZone" type="string" use="optional" default="00"/>
    <attribute name="DaylightSaving" type="string" use="optional"/>
  </complexType>
  <element name="Time" type="this:Time"/>

  <complexType name="SyslogServer">
    <attribute name="Index" type="unsignedInt" use="optional"/>
    <attribute name="InetAddressType" type="this:InetAddressType" use="optional"/>
    <attribute name="InetAddress" type="hexBinary" use="optional"/>
    <attribute name="Enabled" type="boolean" use="optional" default="false"/>
  </complexType>
  <element name="SyslogServer" type="this:SyslogServer"/>

  <complexType name="Registration">
    <attribute name="ErmName" type="string" use="optional"/>
    <attribute name="ErmAddressType" type="this:InetAddressType" use="optional"/>
    <attribute name="ErmAddress" type="hexBinary" use="optional"/>
    <attribute name="ErmPort" type="unsignedInt" use="optional" default="0"/>
    <attribute name="ErmConnectionType" type="optional" default="client">
      <simpleType>
        <restriction base="string">
          <enumeration value="client"/>
          <enumeration value="server"/>
          <enumeration value="clientAndServer"/>
        </restriction>
      </simpleType>
    </attribute>
    <attribute name="HoldTimer" type="unsignedInt" use="optional" default="3"/>
    <attribute name="ConnRetryTimer" type="unsignedInt" use="optional"/>
    <attribute name="NextHopAddressDomain" type="unsignedInt" use="optional"/>
    <attribute name="CompAddress" type="string" use="optional" default=""/>
    <attribute name="StreamingZone" type="string" use="optional" default=""/>
    <attribute name="Id" type="unsignedInt" use="optional"/>
    <attribute name="Cost" type="unsignedInt" use="optional" default="0"/>
    <attribute name="CompName" type="string" use="optional" default=""/>
  </complexType>
  <element name="Registration" type="this:Registration"/>

  <complexType name="TSOutputCfg">
    <attribute name="CatInsertRate" type="unsignedByte" use="optional"/>
    <attribute name="PatInsertRate" type="unsignedByte" use="optional"/>
    <attribute name="PmtInsertRate" type="unsignedByte" use="optional"/>
  </complexType>
  <element name="TSOutputCfg" type="this:TSOutputCfg"/>

  <complexType name="TSInputCfg">
    <attribute name="UnicastSessionLossTimeout" type="unsignedInt" use="optional"/>
    <attribute name="MulticastSessionLossTimeout" type="unsignedInt" use="optional"/>
    <attribute name="JitterTolerance" type="unsignedInt" use="optional"/>
  </complexType>
  <element name="TSInputCfg" type="this:TSInputCfg"/>

  <complexType name="ReservedUdpMap">

```

```

    <attribute name="Index" type="unsignedInt" use="optional"/>
    <attribute name="StartingPort" type="unsignedInt" use="optional" default="0"/>
    <attribute name="Count" type="unsignedInt" use="optional" default="0"/>
</complexType>
<element name="ReservedUdpMap" type="this:ReservedUdpMap"/>

<complexType name="ReservedPidRange">
    <attribute name="Index" type="unsignedInt" use="optional"/>
    <attribute name="StartingPid" type="unsignedInt" use="optional" default="0"/>
    <attribute name="Count" type="unsignedInt" use="optional" default="0"/>
    <attribute name="Description" type="string" use="optional" default=""/>
</complexType>
<element name="ReservedPidRange" type="this:ReservedPidRange"/>

<complexType name="EdgeInput">
    <sequence>
        <element ref="this:InputRegistration" minOccurs="0"/>
    </sequence>
    <attribute name="Name" type="" use="optional"/>
    <attribute name="InetAddressType" type="this:InetAddressType" use="optional"/>
    <attribute name="InetAddress" type="hexBinary" use="optional"/>
</complexType>
<element name="EdgeInput" type="this:EdgeInput"/>

<complexType name="InputRegistration">
    <attribute name="GroupName" type="string" use="optional" default=""/>
    <attribute name="Bandwidth" type="unsignedInt" use="optional" default="0"/>
    <attribute name="ErmName" type="string" use="optional" default=""/>
</complexType>
<element name="InputRegistration" type="this:InputRegistration"/>

<complexType name="RFPort">
    <sequence>
        <element ref="this:FiberNode" minOccurs="0" maxOccurs="unbounded"/>
    </sequence>
    <attribute name="Name" type="" use="optional"/>
    <attribute name="AdminStatus" use="optional" default="disabled">
        <simpleType>
            <restriction base="string">
                <enumeration value="enabled"/>
                <enumeration value="disabled"/>
            </restriction>
        </simpleType>
    </attribute>
    <attribute name="Power" type="int" use="optional" default="0"/>
    <attribute name="Frequency" type="unsignedInt" use="optional" default="0"/>
    <attribute name="Modulation" type="string" use="optional" default="qam256"/>
    <attribute name="InterleaverMode" type="string" use="optional" default="unknown"/>
    <attribute name="InterleaveLevel" use="optional" default="level1">
        <simpleType>
            <restriction base="string">
                <enumeration value="level1"/>
                <enumeration value="level2"/>
            </restriction>
        </simpleType>
    </attribute>
    <attribute name="Annex" use="optional" default="AnnexB">
        <simpleType>
            <restriction base="string">
                <enumeration value="AnnexA"/>
                <enumeration value="AnnexB"/>
                <enumeration value="AnnexC"/>
            </restriction>
        </simpleType>
    </attribute>

```

```

        <enumeration value="other"/>
    </restriction>
</simpleType>
</attribute>
<attribute name="SpectrumInversion" type="boolean" use="optional" default="false"/>
<attribute name="LockParameters" type="hexBinary" use="optional"/>
<attribute name="cfgNumberChannels" type="unsignedInt" use="optional"/>
<attribute name="NumberChannels" type="unsignedInt" use="optional"/>
</complexType>
<element name="RFPort" type="this:RFPort"/>

<complexType name="FiberNode">
    <attribute name="Name" type="" use="optional"/>
</complexType>
<element name="FiberNode" type="this:FiberNode"/>

<complexType name="Channel">
    <sequence>
        <element ref="this:TSPutput" minOccurs="0"/>
        <element ref="this:StaticUdpMap" minOccurs="0" maxOccurs="unbounded"/>
    </sequence>
    <attribute name="PhysName" type="string" use="optional"/>
    <attribute name="RFPortPhysName" type="string" use="optional"/>
    <attribute name="AdminStatus" type="int" use="optional"/>
    <attribute name="Power" type="unsignedInt" use="optional"/>
    <attribute name="Frequency" type="unsignedInt" use="optional"/>
    <attribute name="Modulation" type="int" use="optional"/>
    <attribute name="InterleaverMode" type="int" use="optional"/>
    <attribute name="InterleaverLevel" type="int" use="optional"/>
    <attribute name="Annex" use="optional">
        <simpleType>
            <restriction base="string">
                <enumeration value="AnnexA"/>
                <enumeration value="AnnexB"/>
                <enumeration value="AnnexC"/>
                <enumeration value="other"/>
            </restriction>
        </simpleType>
    </attribute>
    <attribute name="SpectrumInversion" type="boolean" use="optional"/>
    <attribute name="Name" type="string" use="optional" default=""/>
    <attribute name="GroupName" type="string" use="optional" default=""/>
    <attribute name="ErmName" type="string" use="optional" default=""/>
    <attribute name="LockParameters" type="hexBinary" use="optional"/>
    <attribute name="AllocationType" use="optional" default="any">
        <simpleType>
            <restriction base="string">
                <enumeration value="docsisOnly"/>
                <enumeration value="videoOnly"/>
                <enumeration value="any"/>
            </restriction>
        </simpleType>
    </attribute>
    <attribute name="ERRPAvertizing" type="boolean" use="optional" default="true"/>
    <attribute name="DepsUdpPortMapping" type="unsignedInt" use="optional" default="0"/>
</complexType>
<element name="Channel" type="this:Channel"/>

<complexType name="DEPICfg">
    <attribute name="DepsSessionLossTO" type="unsignedInt" use="optional" default="0"/>
</complexType>
<element name="DEPICfg" type="this:DEPICfg"/>

```

```

<complexType name="TSOutput">
  <attribute name="TSID" type="unsignedInt" use="optional" default="0"/>
  <attribute name="NitPid" type="unsignedByte" use="optional" default="0"/>
  <attribute name="CaPid" type="unsignedByte" use="optional" default="0"/>
</complexType>
<element name="TSOutput" type="this:TSOutput"/>

<complexType name="StaticUdpMap">
  <attribute name="StartingPort" type="unsignedInt" use="optional"/>
  <attribute name="Count" type="unsignedInt" use="optional"/>
</complexType>
<element name="StaticUdpMap" type="this:StaticUdpMap"/>

<simpleType name="InetAddressType">
  <restriction base="string">
    <enumeration value="unknown"/>
    <enumeration value="ipv4"/>
    <enumeration value="ipv6"/>
    <enumeration value="dns"/>
  </restriction>
</simpleType>
</schema>

```

B.2.3 DOCS-CABLE-DEVICE_RFC4639.XSD

```

<?xml version="1.0"?>
<schema targetNamespace="urn:cablelabs:namespaces:smi:xsd:DOCS-CABLE-DEVICE:RFC4639"
  xmlns:this="urn:cablelabs:namespaces:smi:xsd:DOCS-CABLE-DEVICE:RFC4639"
  xmlns="http://www.w3.org/2001/XMLSchema"
  elementFormDefault="qualified">
  <complexType name="EvControl">
    <sequence/>
    <attribute name="EvPriority" type="int" use="optional"/>
    <attribute name="EvReporting" type="hexBinary" use="optional"/>
  </complexType>
  <element name="EvControl" type="this:EvControl"/>

  <complexType name="Ev">
    <sequence/>
    <attribute name="SyslogAdress" type="hexBinary" use="optional"/>
    <attribute name="ThrottleAdminstatus" type="int" use="optional"/>
    <attribute name="ThrottleThreshold" type="int" use="optional"/>
    <attribute name="ThrottleInterval" type="unsignedInt" use="optional"/>
    <attribute name="EcContro" type="" use="optional"/>
  </complexType>
  <element name="Ev" type="this:Ev"/>
</schema>

```

B.2.4 SNMPv2_RFC3418.XSD

```

<?xml version="1.0"?>
<schema targetNamespace="urn:cablelabs:namespaces:smi:xsd:SNMPv2:RFC3418"
  xmlns:this="urn:cablelabs:namespaces:smi:xsd:SNMPv2:RFC3418"
  xmlns="http://www.w3.org/2001/XMLSchema"
  elementFormDefault="qualified">
  <complexType name="System">
    <sequence/>
    <attribute name="Name" type="" use="optional"/>
    <attribute name="Contact" type="unsignedInt" use="optional"/>
    <attribute name="Location" type="unsignedInt" use="optional"/>
  </complexType>

```

```
<element name="System" type="this:System"/>
</schema>
```

Annex C DOCS-EQAM Management Requirements

C.1 DOCS-EQAM Object Model Overview

This section defines the management model of the EQAM device. In particular, this section defines the EQAM object model that defines the SNMP management requirements defined in Annex A and C.2, as well as the XML Config file Schema definition in Annex B.

Unless specified, the EQAM MUST NOT persist operator configuration data using the data models herein described.

C.2 DOCS-EQAM Object Model Definitions

C.2.1 DOCS-EQAM Object Model Data Types

There are no defined data types in this object model.

C.2.2 DOCS-EQAM Object Model Class Diagram

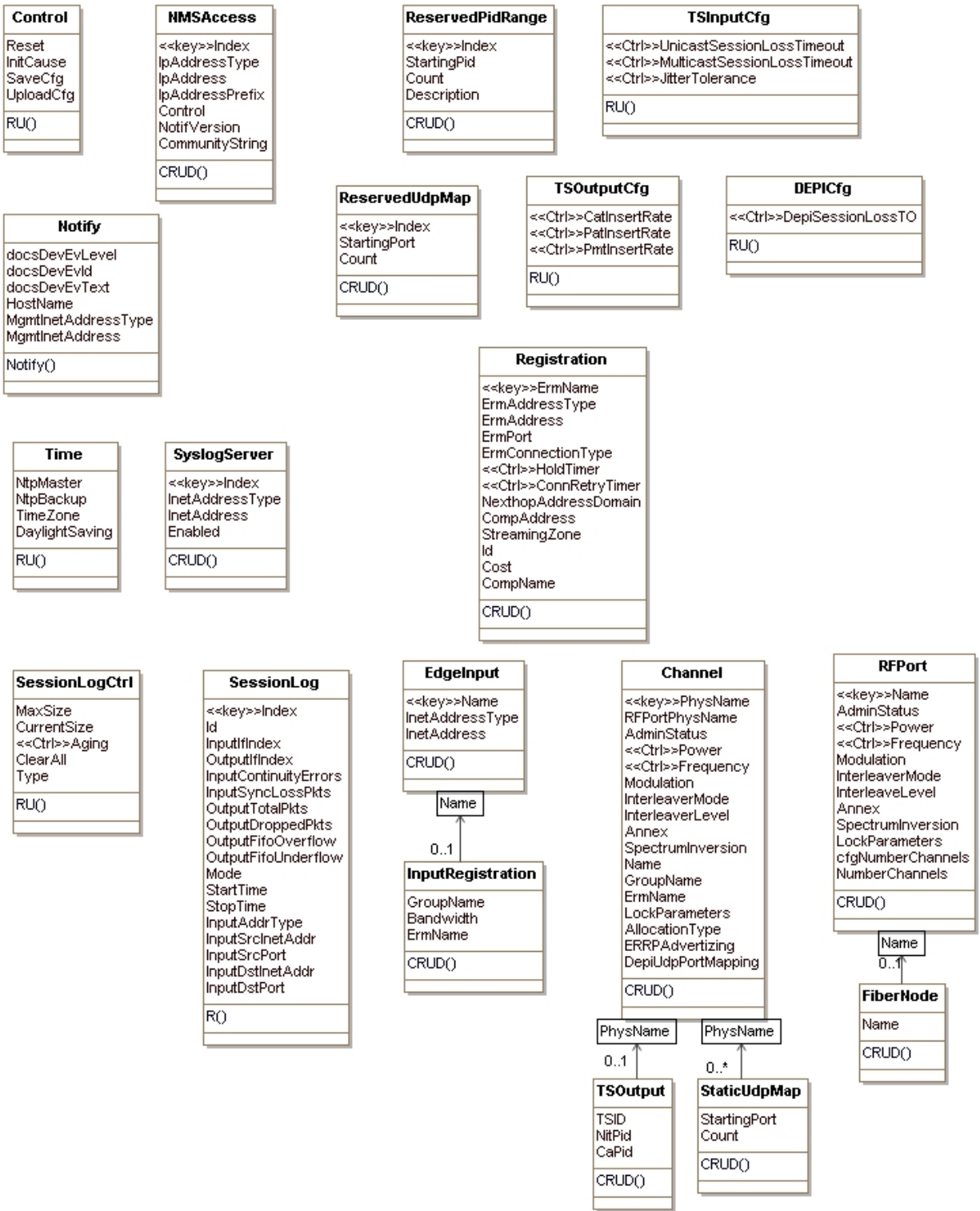

Figure C-1 - QAM Object Model Diagram

C.2.3 DOCS-EQAM Object Model Description

C.2.3.1 Control Object

This object represents general control objects for the EQAM operation.

- Object Operations:
None

Table C-1 - Control Object

Attribute Name	Type	Access	Type Constraints	Units	Default
Reset	Boolean	RU			false
InitCause	Enum	R	nms(1) none(2) unknown(3)		'none'
SaveCfg	AdminString	RU			""
UploadCfg	AdminString	RU			""

- Reset

This attribute controls the administrative reset of the EQAM device. If set to 'true' the EQAM is reinitialized. This attribute always report the value 'reset'. When the EQAM is instructed to reset itself, it MUST execute the following sequence of events:

- Gracefully tear down all sessions if any, i.e., send a session status update to the ERM that will trigger a teardown for each active session to the SRM/ERM.
- Shut down all processes/tasks.
- Restart.

- InitCause

This attribute indicates the reason for the last reinitialization.

- SaveCfg

This attribute provides a mechanism to save the current EQAM configuration in the EQAM file system. A set to a non-zero length string representing a valid local file name, the current running configuration is saved into the file name specified. File names including directory paths are optional.

- UploadCfg

This attribute provides a mechanism to upload the EQAM config file to the configuration server. When set to a URI, the EQAM performs an upload of the current config file being used. TFTP URL is a required URI type. Other URI types may be supported by the EQAM.

C.2.3.2 NMSAccess Object

This object represents the SNMP Access control configuration of the EQAM.

- Object Operations:
None

Table C-2 - NMSAccess Object

Attribute Name	Type	Access	Type Constraints	Units	Default
Index	unsignedInt	key			
IpAddressType	InetAddressType	CRUD			'unknown'
IpAddress	InetAddress	CRUD			"H
IpAddressPrefix	InetAddressPrefixLength	CRUD			0
Control	Enum	CRUD	readOnly(1) readWrite(2) roWithNotif(3) rwWithNotif(4) notifOnly(5)		'readOnly'
NotifVersion	Enum	CRUD	trapV1(1) trapV2c(2) Inform(3)		'trapV2c'
CommunityString	Enum AdminString	CRUD			""

- Index
This key represents the unique identifier of an instance in this object.
- IpAddressType
This attribute represents the address type of the 'IpAddress' attribute.
- IpAddress
This attribute represents the IP address or IP prefix authorized for NMS access to the SNMP agent in the EQAM.
- IpAddressPrefix
This attribute represents the subnet-prefix to be applied to the 'IpAddress' attribute.
- Control
This attribute provides the access control options for the NMS. The valid values include:
 - 'readOnly' provides read-only access.
 - 'readWrite' provides read and write access.
 - 'roWithNotif' provides read access and SNMP notification transmission.
 - 'rwWithNotif' provides read, write, and SNMP notification transmission.
 - 'tNotifOnly' provides SNMP notification transmission.

When an event has an associated SNMP notification definition, the device sends SNMP notifications to all NMS indicated by a valid unicast 'IpAddress' and 'IpAddressPrefix' of all FF octets. Other combinations of 'IpAddress' and 'IpAddressPrefix' are invalid.
- NotifVersion
This attribute represents the SNMP trap or notification version.
- CommunityString
This attribute represents the community string to be matched for SNMP access from the NMS specified.

C.2.3.3 Time Object

This object represents the configuration of ToD.

- Object Operations:
None

Table C-3 - Time Object

Attribute Name	Type	Access	Type Constraints	Units	Default
NtpMaster	InetAddress	CRUD			"H"
NtpBackup	InetAddress	CRUD			"H"
TimeZone	AdminString	CRUD			"00"
DaylightSaving	AdminString	CRUD			""

- NtpMaster**
This attribute represents the Master NTP server. This element is not required in case ToD is acquired via DHCP. If DHCP options for ToD are provided and this element is present, the EQAM selects this element.
- NtpBackup**
This attribute represents the backup NTP Server in case the master NTP fails.
- TimeZone**
This attribute represents the offset value to the local time to arrive at UTC Time. The value has the following format:
hh[:mm] - the hour
(0 <= hh <= 24) - required, minutes
(0 <= mm <= 59) -the mm (minutes) is optional. The hour can be preceded by a minus sign (-).
- DaylightSaving**
This attribute indicates when to change to and from daylight saving (or summer) time. The value has the form: date1/time1,date2/time2,offset. The first date describes when the change from standard to daylight saving time occurs, and the second date describes when the change back happens.
Each time field describes when, in current local time, the change to the other time is made. The format of date is the following: m.w.d - The dth day (0 <= d <= 6) of week w of month m of the year (1 <= w <= 5, 1 <= m <= 12, where week 5 means 'the last d day in month m', which may occur in the fourth or fifth week). Week 1 is the first week in which the dth day occurs. Day zero is Sunday.
The time format is the following: hh:mm - The offset value is the value you must add to the local time to arrive at UTC Time during the daylight saving time. The offset value has the following format: hh[:mm].

C.2.3.4 SyslogServer Object

This object represents the syslog server's configuration.

- Object Operations:
None

Table C-4 - SyslogServer Object

Attribute Name	Type	Access	Type Constraints	Units	Default
Index	unsignedInt	key			
InetAddressType	InetAddressType	CRUD			'unknown'
InetAddress	InetAddress	CRUD			""
Enabled	boolean	CRUD			'false'

- Index
This key represents the unique identifier of an instance in this object.
- InetAddressType
This attribute indicates the address type of the syslog server IP address. 'dns' support is optional.
- InetAddress
This attribute represents the IP address of the syslog server. If DNS is supported, this attribute can contain the FQDN of the syslog server.
- Enabled
Indicates if the syslog server is user for sending syslog messages or is disabled.

C.2.3.5 Registration Object

This object represents the configuration of the ERRP protocol.

- Object Operations:
None

Table C-5 - Registration Object

Attribute Name	Type	Access	Type Constraints	Units	Default
ErmName	AdminString	key			
ErmAddressType	InetAddressType	CRUD			'unknown'
ErmAddress	InetAddress	CRUD			"H"
ErmPort	InetAddressNumber	CRUD			0
ErmConnectionType	Enum	CRUD	client(1) server(2) clientAndServer(3)		'client'
HoldTimer	unsignedInt	CRUD		seconds	3
ConnRetryTimer	unsignedInt	CRUD		seconds	20
NextHopAddressDomain	unsignedInt	CRUD	0 3..60		
CompAddress	AdminString	CRUD			""
StreamingZone	AdminString	CRUD			""
Id	unsignedInt	CRUD			0
Cost	unsignedInt	CRUD			0
CompName	AdminString	CRUD			""

- ErmName
This key represents the name of the ERM related to this registration instance. This is an internal reference for associating, e.g., QAM channels and input interfaces to an ERM.

- **ErmAddressType**

This attribute represents the InetAddress of the ERM.
- **ErmAddress**

This attribute represents the IP Address of the ERM.
- **ErmPort**

This attribute represents the TCP port number used to reach the ERM.
- **ErmConnectionType**

This attribute represents the type of TCP connection that must be supported by the EQAM. The value can be one of the following:

 - 'client' indicates that the EQAM has to initiate the TCP connection with the ERM.
 - 'server' indicates that the EQAM has to wait the TCP connection from the ERM.
 - 'clientAndServer' indicates that both EQAM or either EQAM or ERM can initiate the TCP connection.
- **HoldTimer**

This attribute represents the number of seconds that the sender proposes for the value of the hold timer. Upon receipt of an OPEN message, the EQAM MUST calculate the value of the Hold Timer by using the smaller of its configured Hold Time and the Hold Time received in the OPEN message.

The Hold Time MUST be either zero or at least three seconds. An implementation MAY reject connections on the basis of the Hold Time. The calculated value indicates the maximum number of seconds that may elapse between the receipt of successive KEEPALIVE and/or UPDATE messages by the sender.
- **ConnRetryTimer**

This attribute represents the time in seconds for the connect retry timer. The exact value of the connect retry timer is a local matter, but should be sufficiently large to allow TCP initialization.
- **NextHopAddressDomain**

This attribute represents the address domain number of the next-hop server. The NextHopServer specifies the address to which a manager should use to connect to the component in order to control the resource specified in the reachable route. This parameter is used in the ERRP NextHopServer attribute.
- **CompAddress**

This attribute represents the ERRP NextHopServer attribute. This field contains a string that conforms to the following syntax: CompAddress = host[:port] host = An FQDN, or an IPv4 address using the textual representation defined in section 2.1 of [RFC 1123], or an IPv6 address using the textual representation defined in section 2.2 of [RFC 4291] and enclosed in '[' and ']' characters. port = numerical value (1-65535). If the port is empty or not given, the default port 6069 is assumed.
- **StreamingZone**

This attribute represents the Streaming Zone within which the component operates. This parameter is used in the ERRP OPEN message. StreamingZone Name is a mandatory parameter when supporting video applications. The capability is optional when signaling DOCSIS only resources.

The value is to be set to the string that represents the StreamingZone Name, i.e., <region>. The characters comprising the string are in the set within TEXT defined in section 15.1 of [RFC 2326]. Implementations must support minimum string lengths of 64; however, the composition of the string used is defined by implementation agreements specified by the service provider.

- **Id**
This attribute represents the unique identifier for the EQAM device within its Streaming Zone. This value may be set to the 4-octet value of an IPv4 address assigned to that device. This ID value is determined on startup and must be the same for all peer connections. This parameter is used in the ERRP OPEN message header.
- **Cost**
This attribute represents the static cost for use of this resource.
- **CompName**
The name of the component for which the data in the update message applies. This parameter is used in the ERRP OPEN message. Component Name is a mandatory parameter when supporting video applications. The capability is optional when signaling DOCSIS only resources.

The value is to be set to the string that represents the Component Name, i.e., <region>.<localname>. The characters comprising the string are in the set within TEXT defined in section 15.1 of [RFC 2326]. Implementations must support minimum string lengths of 64; however the composition of the string used is defined by implementation agreements specified by the service provider.

C.2.3.6 *TSInputCfg Object*

This object represents EQAM global configuration of input transport streams.

- **Object Operations:**
None

Table C-6 - TSInputCfg Object

Attribute Name	Type	Access	Type Constraints	Units	Default
UnicastSessionLossTimeout	unsignedInt	RU		milliseconds	40
MulticastSessionLossTimeout	unsignedInt	RU		milliseconds	40
JitterTolerance	unsignedInt	RU		milliseconds	

- **UnicastSessionLossTimeout**
This attribute represents the loss of signal timeout in milliseconds for unicast input streams. See [SCTE 154-4] mpegLossOfSignalTimeout.
- **MulticastSessionLossTimeout**
This attribute represents the loss of signal timeout in milliseconds for the multicast input streams.
- **JitterTolerance**
This attribute represents the acceptable delay variation in millisecond for incoming streams. The jitter option sets the size of a dejittering buffer that absorbs the input jitter of a session.

C.2.3.7 *TSOutputCfg Object*

This object represents EQAM global configuration of output transport streams.

- **Object Operations:**
None

Table C-7 - TSOutputCfg Object

Attribute Name	Type	Access	Type Constraints	Units	Default
CatInsertRate	unsignedByte	RU	0..32	tables/seconds	10
PatInsertRate	unsignedByte	RU	0..32	tables/seconds	10
PmtInsertRate	unsignedByte	RU	0..32	tables/seconds	10

- CatInsertRate

This attribute represents the CAT insertion rate expressed in tables/second (see [SCTE 154-4] mpegOutputTSCatInsertRate).

- PatInsertRate

This attribute represents the PAT table interval expressed in tables/second (see [SCTE 154-4] mpegOutputTSPatInsertRate).

- PmtInsertRate

This attribute represents the PMT table interval expressed in tables/second (see [SCTE 154-4] mpegOutputTSPatInsertRate).

C.2.3.8 ReservedUdpMap Object

This object represents reserved ports to be used for non-video applications.

- Object Operations:

None

Table C-8 - ReservedUdpMap Object

Attribute Name	Type	Access	Type Constraints	Units	Default
Index	unsignedInt	Key			
StartingPort	unsignedInt	CRUD			0
Count	unsignedInt	CRUD			0

- Index

This key represents the unique identifier of an instance in this object.

- StartingPort

This attribute represents the port range start value for non-video applications reserved UDP ports.

- Count

This attribute represents the number of reserved UDP ports starting from 'StartingPort' attribute value.

C.2.3.9 ReservedPidRange Object

This object represents reserved PID range to not be used on ERM assignments.

- Object Operations:

None

Table C-9 - ReservedPidRange Object

Attribute Name	Type	Access	Type Constraints	Units	Default
Index	unsignedInt	key			

StartingPid	HePIDValue	CRUD		0
Count	unsignedInt	CRUD		0
Description	AdminString	CRUD		""

- Index
This key represents the unique identifier of an instance in this object.
- StartingPid
This attribute represents the PID range starts for other applications reserved PIDs.
- Count
This attribute represents the number of reserved PIDs starting from 'StartingPid' attribute value.
- Description
This attribute represents the description associated with a PID range configured instance.

C.2.3.10 *DEPICfg Object*

This object represents the configuration of M-CMTS DEPI parameters.

- Object Operations:
None

Table C-10 - DEPICfg Object

Attribute Name	Type	Access	Type Constraints	Units	Default
DepiSessionLossTO	unsignedInt	RU		seconds	0

- DepiSessionLossTO
This attribute indicates the Timeout in seconds the EQAM waits after a QAM channel session is terminated to advertize the QAM channel as idle to the ERM. This attribute is only meaningful for dynamic DEPI session allocation, not for static sessions.

C.2.3.11 *EdgeInput Object*

This object represents the configuration of Input Edge parameters.

- Object Operations:
None

Table C-11 - EdgeInput Object

Attribute Name	Type	Access	Type Constraints	Units	Default
Name	AdminString	key			
IpAddressType	InetAddress	CRUD			'unknown'
IpAddress	InetAddress	CRUD			"H"

- Name
This key represents the Input interface name. This name corresponds to the [RFC 4133], ENTITY-MIB entPhysicalName.
- IpAddressType

This attribute represents the IP address type of the 'IpAddress' attribute.

- IpAddress

This attribute represents the IP address of the Edge interface. If not included, the EQAM should use DHCP to acquire the IP address of the Edge input interface.

C.2.3.12 *InputRegistration Object*

This object represents the configuration of Edge ERRP parameters.

- Object Operations:

None

Table C-12 - InputRegistration

Attribute Name	Type	Access	Type Constraints	Units	Default
GroupName	AdminString	CRUD			""
Bandwidth	unsignedInt	CRUD			0
ErmName	AdminString	CRUD			""

- GroupName

This attribute represents the name of the Edge Input Group associated with this input. This parameter is used in the ERRP Edge Input attribute.

- Bandwidth

This attribute represents the bandwidth of the edge input to be advertized. If zero or not present, the EQAM advertizes the full bandwidth of the edge input.

- ErmName

This attribute represents the ERM where the QAM channel is advertized. If empty, the QAM channel is not advertized.

C.2.3.13 *RFPort Object*

This object represents the configuration of RF ports. The parameters configured in a RF port applies to all the QAM channels within the RF Port, unless explicit EQAM configuration is defined.

- Object Operations:

None

Table C-13 - RFPort Object

Attribute Name	Type	Access	Type Constraints	Units	Default
Name		key			
AdminStatus	Enum	CRUD	enabled(1) disabled(2)		'enabled'
Power	TenthdBmV	CRUD		TenthdBmV	0
Frequency	unsignedInt	CRUD		Hertz	0
Modulation	Enum	CRUD	QAMChannelModulationFormat		'qam256'
InterleaverMode	Enum	CRUD	QAMChannelInterleaveMode		'unknown'
InterleaveLevel	Enum	CRUD	level1(1) level2(2)		'level1'

Attribute Name	Type	Access	Type Constraints	Units	Default
Annex	Enum	CRUD	annexA(1) annexB(2) annexC(3) other (4)		'annexB'
SpectrumInversion	boolean	CRUD			'false'
LockParameters	EnumBits	CRUD	frequency(0) bandwidth(1) power(2) modulation(3) interleaver(4) j83Annex(5) symbolRate(6) mute(7)		"H"
cfgNumberChannels	unsignedInt	CRUD			
NumberChannels	unsignedInt	R			

- **Name**
This key represents the RF port identifier. It corresponds to [RFC 4133], ENTITY-MIB entPhysicalName.
- **AdminStatus**
This attribute represents the administrative state of the RF Port. Setting this element to 'disable' results in the RF port being muted. By default this element reports 'disabled'.
- **Power**
This attribute represents the power level for the QAM channels in the containment level.
- **Frequency**
This attribute represents the first carrier of the configured carriers within the RF port.
- **Modulation**
This attribute represents the Modulation type for the QAM channels in the containment level.
- **InterleaverMode**
This attribute represents the Interleave mode for the QAM channels in the containment level.
- **InterleaveLevel**
This attribute represents the interleaver level for FEC coding for the QAM channels in the containment level.
- **Annex**
This attribute represents the ITU J.83 Annex mode for the QAM channels in the containment level.
- **SpectrumInversion**
This attribute represents the QAM Signal Spectrum inversion. A value of 'true' indicates channel spectrum is inverted.
- **LockParameters**
This attribute represents the PHY parameters Lock state of the QAM channels in the RF Port containment level for DEPI initiated PHY parameters updates. This parameter is only required for M-CMTS QAMs.
- **cfgNumberChannels**

This attribute represents the number of QAM channels to configure in the channel block. By default all the channels in the RF port are configured.

- NumberChannels

This attribute indicates the total number of QAM channels within the RF.

C.2.3.14 *FiberNode Object*

This object represents the list of Fiber Nodes the RF port reaches.

- Object Operations:

None

Table C-14 - FiberNode Object

Attribute Name	Type	Access	Type Constraints	Units	Default
Name	AdminString	CRUD			""

- Name

This attribute represents the Fiber Node Name associated with the RF Port

C.2.3.15 *Channel Object*

This object represents the configuration of QAM channels.

- Object Operations:

None

Table C-15 - Channel Object

Attribute Name	Type	Access	Type Constraints	Units	Default
PhysName	AdminString	Key			
RFPortPhysName	AdminString	R			
AdminStatus	Enum	CRUD	enabled(1) disabled(2)		'enabled'
Power	unsignedInt	CRUD		TenthdBmV	0
Frequency	unsignedInt	CRUD		Hertz	0
Modulation	Enum	CRUD	QAMChannelModulationFormat		'qam256'
InterleaverMode	Enum	CRUD	QAMChannelInterleaveMode		'unknown'
InterleaverLevel	Enum	CRUD	level1(1) level2(2)		'level1'
Annex	Enum	CRUD	annexA(1) annexB(2) annexC(3) other (4)		'annexB'
SpectrumInversion	boolean	CRUD			'false'
Name	AdminString	CRUD			""
GroupName	AdminString	CRUD			""
ErmName	AdminString	CRUD			""

Attribute Name	Type	Access	Type Constraints	Units	Default
LockParameters	EnumBits	R	frequency(0) bandwidth(1) power(2) modulation(3) interleaver(4) j83Annex(5) symbolRate(6) mute(7)		"H"
AllocationType	Enum	CRUD	docsisOnly(1) videoOnly(2) any(3)		'any'
ERRPAdvertizing	boolean	CRUD			'true'
DepiUdpPortMapping	InetPortNumber	CRUD			0

- **PhysName**
This attribute represents the QAM channel identifier. It corresponds to [RFC 4133], ENTITY-MIB entPhysicalName.
- **RFPortPhysName**
This attribute represents the RF port identifier of the QAM channel. It corresponds to [RFC 4133], ENTITY-MIB entPhysicalName.
- **AdminStatus**
This attribute represents the administrative state of the QAM channel. Setting this element to 'disable' results in the RF port being muted. By default this element reports 'disabled'.
- **Power**
This attribute represents the power level for the QAM channel.
- **Frequency**
This attribute represents the carrier frequency of the QAM channel.
- **Modulation**
This attribute represents the Modulation type for the QAM channel.
- **InterleaverMode**
This attribute represents the Interleave mode of the QAM channel.
- **InterleaverLevel**
This attribute represents the interleaver level for FEC coding of the QAM channel.
- **Annex**
This attribute represents the ITU J.83 Annex mode of the QAM channel.
- **SpectrumInversion**
This attribute represents the QAM Signal Spectrum inversion. A value 'true' indicates channel spectrum is inverted.
- **Name**
This attribute represents the name of the QAM channel. This parameter is used in the ERRP QAM Name attribute.

- **GroupName**
This attribute represents the address field in the WithdrawnRoute and ReachableRoutes ERRP attributes.
- **ErmName**
This attribute represents the ERM where the QAM channel is advertised. If empty, the QAM channel is not advertised.
- **LockParameters**
This attribute represents the PHY parameters Lock state of the QAM channels for DEPI-initiated PHY parameters updates. This parameter is only required for M-CMTS QAMs.
- **AllocationType**
This attribute indicates the mechanisms authorized to reserve and control the QAM channels. The possible values are:
 - 'docsisOnly' - the QAM channel can be allocated statically or dynamically to DOCSIS.
 - 'videoOnly' - the QAM channel can be allocated statically or dynamically to video.
 - 'any' - indicates the QAM channel can be allocated statically or dynamically to video and/or DOCSIS.
- **ERRPAdvertising**
CM - This attribute represents the ERRP advertisement state of the QAM channel. If set to 'true', the QAM channel is advertised; otherwise it is not advertised. This is primarily useful when statically configuring the QAM channels and when the QAM channel is not made part of the ERM channel list.
- **DepiUdpPortMapping**
This attribute represents the static UDP port assignment for a DEPI UDP tunnel. The value zero indicates there is not static mapping or it is not applicable.

C.2.3.16 *TSOutput Object*

This object represents transport stream configuration parameters for QAM channels.

- **Object Operations:**
None

Table C-16 - TSOutput Object

Attribute Name	Type	Access	Type Constraints	Units	Default
TSID	unsignedInt	CRUD			0
NitPid	unsignedByte	CRUD			0
CaPid	unsignedByte	CRUD			0

- **TSID**
This attribute represents the TSID of the output transport stream. See [SCTE 154-4] mpegOutputTSTSID.
- **NitPid**
This attribute represents the NIT PID of the outgoing transport stream. See [SCTE 154-4] mpegOutputTSNitPid.
- **CaPid**
This attribute represents the CA PID of the outgoing transport stream. See [SCTE 154-4] mpegOutputTSCaPid.

C.2.3.17 StaticUdpMap Object

This object represents the UDP port ranges used for static video sessions.

- Object Operations:
None

Table C-17 - StaticUdpMap Object

Attribute Name	Type	Access	Type Constraints	Units	Default
StartingPort	unsignedInt	CRUD			0
Count	unsignedInt	CRUD			0

- StartingPort
This attribute represents the UDP port range start value for static session.
- Count
This attribute represents the number of reserved UDP ports starting from 'StartingPort' attribute value.

C.2.3.18 SessionLogCtrl Object

This object defines the control mechanisms for the 'SessionLog' object.

- Object Operations:
None

Table C-18 - SessionLogCtrl

Attribute Name	Type	Access	Type Constraints	Units	Default
MaxSize	unsignedInt	RU			100
CurrentSize	unsignedInt	R			
Aging	unsignedInt	RU		seconds	10080
ClearAll	boolean	RU			'false'
Type	Enum	RU	allSessions(1) sessionsWithExceptions(2)		'sessionsWithExceptions'

- MaxSize
This attribute represents the maximum number of mpeg session entries that the 'SessionLog' can report. Upon a set operation, the lower value between the set value and the supported number of log entries is used.
- CurrentSize
This attribute represents the current number of mpeg session entries in the 'SessionLog'.
- Aging
This attribute represents the Aging threshold for the 'SessionLog'. Periodically, a process scans through 'SessionLog' and removes those sessions that have a 'SessionLog::StopTime' greater than this threshold in minutes. A value of 0 means no aging out log entries.
- ClearAll
This attribute provides a control to clear the 'Session log'. If set to 'true', all entries from the 'SessionLog' object are removed. Reading this attribute always returns 'false'.

- Type

This attribute indicates which type of video sessions are reported in the 'SessionLog' object. The value 'allSessions' indicates all video sessions are reported in the 'SessionLog'. The value 'sessionsWithExceptions' indicates that video sessions are reported when either of the conditions below occur:

- The Continuity Errors or Synch Loss Packets of the associated session is greater than zero.
- The Dropped packets, FIFO Overflow, or FIFO Underflow is greater than zero.

C.2.3.19 SessionLog Object

This object represents the list of terminated MPEG video sessions. All parameters values reported for a session are determined at the time of the session deletion.

- Object Operations:

None

Table C-19 - SessionLog

Attribute Name	Type	Access	Type Constraints	Units	Default
Index	unsignedInt	Key			
Id	unsignedInt	R			
InputIfIndex	InterfaceIndex	R			
OutputIfIndex	InterfaceIndex	R			
InputContinuityErrors	Counter32	R			
InputSyncLossPkts	Counter32	R			
OutputTotalPkts	Counter64	R			
OutputDroppedPkts	Counter32	R			
OutputFifoOverflow	Counter32	R			
OutputFifoUnderflow	Counter32	R			
Mode	Enum	R	other(1) passThrough(2) multiplexing(3)		
StartTime	dateTime	R			
StopTime	dateTime	R			
InputAddrType	InetAddressType	R			
InputSrcInetAddr	InetAddress	R			
InputSrcPort	InetAddressNumber	R			
InputDstInetAddr	InetAddress	RU			
InputDstPort	InetAddressNumber	RU			

- Index

This key represents the unique identifier of an instance in this object. This attribute's behavior consists of an incremental value. If the maximum number of instances is reached, the log instance with the lower key value is deleted and the new instance is added.

- Id

This attribute identifies the MPEG Session Id of this entry.

- InputIfIndex

This attribute identifies the interface index of the mpeg source stream.

- **OutputIfIndex**
This attribute identifies the interface index of the mpeg output stream.
- **InputContinuityErrors**
This attribute indicates the total number of continuity counter errors for the session. See [SCTE 154-4] `mpegInputStatsContinuityErrors` for details of the count definition.
- **InputSyncLossPkts**
This attribute indicates the total number of MPEG packets that had missing a sync byte for the session. See [SCTE 154-4] `mpgInputStatsSyncLossPackets` for details of the count definition.
- **OutputTotalPkts**
This attribute indicates the total number of MPEG output packets for the session.
- **OutputDroppedPkts**
This attribute indicates the total number of MPEG output packets dropped for the session.
- **OutputFifoOverflow**
This attribute indicates the total number of FIFO overflows of the session.
- **OutputFifoUnderflow**
This attribute indicates the total number of FIFO underflows of the session.
- **Mode**
This attribute indicates the type of session. See [SCTE 154-4] `docsQamVideoSessionMode` for definitions of the type of sessions.
- **StartTime**
This attribute indicates the date and time when the session was setup.
- **StopTime**
This attribute indicates the date and time when the session was deleted.
- **InputAddrType**
This attribute indicates the address type associated with the input transport stream of the session. The value 'unknown' indicates no IP transport associated to the transport stream. The value 'dns' is not used.
- **InputSrcInetAddr**
This attribute indicates the source address of the IP flow contained in the session. For Multicast, it represents the Source Specific Multicast IP Address of the UDP IP flow. For unicast, UDP IP flows is either the value 0.0.0.0 if the IP source address is unknown or irrelevant for the origination transport stream.
- **InputSrcPort**
This attribute indicates the source port of the UDP IP flow of the input transport stream.
- **InputDstInetAddr**
This attribute indicates the destination address of the IP flow contained in the session. For multicast, it represents the group address of the SSM origination input TS. For unicast, UDP IP flows is either the value 0.0.0.0 if the IP destination address is unknown or irrelevant for the origination input stream.
- **InputDstPort**
This attribute indicates the UDP destination port of the UDP IP flow of the input transport stream.

C.2.3.20 Notify Object

This object corresponds to a generic notification used by the EQAM to send events.

- Object Operations:
None

Table C-20 - Notify Object

Attribute Name	Type	Access	Type Constraints	Units	Default
EvLevel	unsignedInt	Notify			
docsDevEvId	unsignedInt	Notify			
docsDevEvText	AdminString	Notify			
sysName	AdminString	Notify			
MgmtInetAddressType	InetAddressType	Notify			
MgmtInetAddress	InetAddress	Notify			

- EvLevel
This attribute represents the event level of the event.
Reference: docsEvLevel from DOCS-CABLE-DEVICE-MIB
- docsDevEvId
This attribute represents the event id of the event.
Reference: docsEvId from DOCS-CABLE-DEVICE-MIB
- docsDevEvText
This attribute represents the text of the Event.
Reference: docsEvText from DOCS-CABLE-DEVICE-MIB
- HostName
Reference: sysName from SNMPv2-MIB.
- MgmtInetAddressType
This attribute represents the address type of the EQAM management IP address.
- MgmtInetAddress
This attribute represents that the EQAM management IP address or the FQDN if DNS is supported,

C.3 EQAM MIB Module

```
DOCS-EQAM-MIB DEFINITIONS ::= BEGIN
```

```
IMPORTS
    MODULE-IDENTITY,
    OBJECT-TYPE,
    NOTIFICATION-TYPE,
    Unsigned32,
    Counter32,
    Counter64
        FROM SNMPv2-SMI
    OBJECT-GROUP,
    MODULE-COMPLIANCE
        FROM SNMPv2-CONF
    SnmpAdminString
```

```
FROM SNMP-FRAMEWORK-MIB
TruthValue,
DateAndTime,
RowStatus
FROM SNMPv2-TC
InetAddressType,
InetAddress,
InetPortNumber
FROM INET-ADDRESS-MIB
InterfaceIndex
FROM IF-MIB
TenthdBmV
FROM DOCS-IF-MIB
docsDevEvLevel,
docsDevEvId,
docsDevEvText FROM DOCS-CABLE-DEVICE-MIB

sysName FROM SNMPv2-MIB

HePIDValue,
QAMChannelInterleaveMode,
QAMChannelModulationFormat
FROM SCTE-HMS-HEADENDIDENT-TC-MIB
clabProjDocsis
FROM CLAB-DEF-MIB;

docsEqamMib MODULE-IDENTITY
LAST-UPDATED "200812090000Z" -- December 09, 2008
ORGANIZATION "Cable Television Laboratories, Inc."
CONTACT-INFO
    "Broadband Network Services
    Cable Television Laboratories, Inc.
    858 Coal Creek Circle,
    Louisville, CO 80027, USA
    Phone: +1 303-661-9100
    Email: mibs@cablelabs.com"
DESCRIPTION
    "This MIB module contains the EQAM
    management requirements."
REVISION "200812090000Z" -- Dec 09, 2008
DESCRIPTION
    "Initial version, published as part of the CableLabs
    Edge QAM Provisioning and Management Interface
    Specification CM-SP-EQAM-PMI-I01-081209
    Copyright 1999-2008 Cable Television Laboratories, Inc.
    All rights reserved."
 ::= { clabProjDocsis 24 }

-- Textual Conventions

-- Object Definitions
docsEqamNotifications OBJECT IDENTIFIER ::= { docsEqamMib 0 }

docsEqamNotificationObjects OBJECT IDENTIFIER ::= { docsEqamNotifications 1 }

docsEqamNotifyMgmtInetAddressType OBJECT-TYPE
SYNTAX InetAddressType
MAX-ACCESS accessible-for-notify
STATUS current
DESCRIPTION
```

"This attribute represents the address type of the EQAM management IP address."
 ::= { docsEqamNotificationObjects 1 }

docsEqamNotifyMgmtInetAddress OBJECT-TYPE

SYNTAX InetAddress

MAX-ACCESS accessible-for-notify

STATUS current

DESCRIPTION

"This attribute represents the EQAM management IP address, or the FQDN if DNS is supported."

::= { docsEqamNotificationObjects 2 }

docsEqamNotify NOTIFICATION-TYPE

OBJECTS {

docsDevEvLevel,

docsDevEvId,

docsDevEvText,

sysName,

docsEqamNotifyMgmtInetAddressType,

docsEqamNotifyMgmtInetAddress

}

STATUS current

DESCRIPTION

"This object corresponds to a generic notification used by the EQAM to send events.

This notification sends additional information about the as follows.

- docsDevEvLevel

This attribute represents the event level of the event.

Reference: docsDevEvLevel from DOCS-CABLE-DEVICE-MIB.

- docsDevEvId

This attribute represents the event id of the event.

Reference: docsDevEvId from DOCS-CABLE-DEVICE-MIB.

- docsDevEvText

This attribute represents the event text of the event.

Reference: docsDevEvText from DOCS-CABLE-DEVICE-MIB.

- docsEqamNotifyMgmtInetAddressType.

See definition within this MIB Module

- docsEqamNotifyMgmtInetAddress

See definition within this MIB Module

::= { docsEqamNotifications 2 }

docsEqamObjects OBJECT IDENTIFIER ::= { docsEqamMib 1 }

docsEqamControl OBJECT IDENTIFIER ::= { docsEqamObjects 1 }

docsEqamControlReset OBJECT-TYPE

SYNTAX TruthValue

MAX-ACCESS read-write

STATUS current

DESCRIPTION

"This attribute controls the administrative reset of the EQAM device.

If set to 'true' the EQAM is reinitialized. This attribute always report the value 'reset'.

When the EQAM is instructed to reset itself, it MUST execute the following sequence of events:

- Gracefully tear down all sessions if any, i.e., send a session status update to the ERM that will trigger a teardown for each active session to the SRM/ERM.

- Shut down all processes/tasks.

- Restart."

DEFVAL { false }
 ::= { docsEqamControl 1 }

docsEqamControlInitCause OBJECT-TYPE

SYNTAX INTEGER
 { nms(1),
 none(2),
 unknown(3)
 }

MAX-ACCESS read-only

STATUS current

DESCRIPTION

"This attribute indicates the reason for the last reinitialization."

DEFVAL { none }

::= { docsEqamControl 2 }

docsEqamControlSaveCfg OBJECT-TYPE

SYNTAX SnmpAdminString

MAX-ACCESS read-write

STATUS current

DESCRIPTION

"This attribute provides a mechanism to save the current EQAM configuration in the EQAM file system. A set to a non-zero length string representing a valid local file name, the current running configuration is saved into the file name specified. File names including directory paths are optional."

DEFVAL { "" }

::= { docsEqamControl 3 }

docsEqamControlUploadCfg OBJECT-TYPE

SYNTAX SnmpAdminString

MAX-ACCESS read-write

STATUS current

DESCRIPTION

"This attribute provides a mechanism to upload the EQAM config file to the configuration server. When set to a URI, the EQAM performs an upload of the current config file being used. TFTP URL is a required URI type. Other URI types maybe supported by the EQAM."

DEFVAL { "" }

::= { docsEqamControl 4 }

docsEqamTime OBJECT IDENTIFIER ::= { docsEqamObjects 2 }

docsEqamTimeNtpMaster OBJECT-TYPE

SYNTAX InetAddress

MAX-ACCESS read-write

STATUS current

DESCRIPTION

"This attribute represents the Master NTP server. This element is not required in case ToD is acquired via DHCP. If DHCP options for ToD are provided and this element is present, the EQAM selects this element."

DEFVAL {"H" }

::= { docsEqamTime 1 }

docsEqamTimeNtpBackup OBJECT-TYPE

SYNTAX InetAddress

MAX-ACCESS read-write

STATUS current

DESCRIPTION

"This attribute represents the backup NTP Server in case the master NTP fails."

DEFVAL {"H" }

::= { docsEqamTime 2 }

docsEqamTimeTimeZone OBJECT-TYPE

SYNTAX SnmpAdminString
 MAX-ACCESS read-write
 STATUS current
 DESCRIPTION

"This attribute represents the offset value to the local time to arrive at UTC Time. The value has the following format:
 hh[:mm]

The hour (0 <= hh <= 24) is required,

minutes (0 < mm <= 59)

The mm (minutes) is optional.

The hour can be preceded by a minus sign (-)."

DEFVAL { '00' }
 ::= { docsEqamTime 3 }

docsEqamTimeDaylightSaving OBJECT-TYPE

SYNTAX SnmpAdminString
 MAX-ACCESS read-write
 STATUS current
 DESCRIPTION

"This attribute indicates when to change to and from daylight saving (or summer) time.

The value has the form:

date1/time1,date2/time2,offset

The first date describes when the change from standard to daylight saving time occurs, and the second date describes when the change back happens. Each time field describes when, in current local time, the change to the other time is made.

The format of date is the following:

m.w.d

The dth day (0 <= d <= 6) of week w of month m of the year (1 <= w <= 5, 1 <= m <= 12, where week 5 means 'the last d day in month m', which may occur in the fourth or fifth week). Week 1 is the first week in which the dth day occurs.

Day zero is Sunday.

The time format is the following: hh:mm

The offset value is the value you must add to the local time to arrive at UTC Time during the daylight saving time. The offset value has the following format: hh[:mm]."

DEFVAL { "" }
 ::= { docsEqamTime 4 }

docsEqamSyslogServerTable OBJECT-TYPE

SYNTAX SEQUENCE OF DocsEqamSyslogServerEntry
 MAX-ACCESS not-accessible
 STATUS current
 DESCRIPTION

"This object represents the syslog server's configuration."

::= { docsEqamObjects 3 }

docsEqamSyslogServerEntry OBJECT-TYPE

SYNTAX DocsEqamSyslogServerEntry
 MAX-ACCESS not-accessible
 STATUS current
 DESCRIPTION

"The Conceptual row of docsEqamSyslogServerTable"

INDEX {
 docsEqamSyslogServerIndex
 }
 ::= { docsEqamSyslogServerTable 1 }

DocsEqamSyslogServerEntry ::= SEQUENCE {

docsEqamSyslogServerIndex
 Unsigned32,
 docsEqamSyslogServerInetAddressType
 InetAddressType,
 docsEqamSyslogServerInetAddress
 InetAddress,

```
docsEqamSyslogServerEnabled
    TruthValue,
docsEqamSyslogRowStatus
    RowStatus
}

docsEqamSyslogServerIndex OBJECT-TYPE
SYNTAX Unsigned32
MAX-ACCESS not-accessible
STATUS current
DESCRIPTION
    "This key represents the unique identifier of an instance in this object."
 ::= { docsEqamSyslogServerEntry 1 }

docsEqamSyslogServerInetAddressType OBJECT-TYPE
SYNTAX InetAddressType
MAX-ACCESS read-create
STATUS current
DESCRIPTION
    "This attribute indicates the address type of the syslog server IP address. 'dns' support is optional."
DEFVAL { unknown }
 ::= { docsEqamSyslogServerEntry 2 }

docsEqamSyslogServerInetAddress OBJECT-TYPE
SYNTAX InetAddress
MAX-ACCESS read-create
STATUS current
DESCRIPTION
    "This attribute represents the IP address of the syslog server. If DNS is supported, this attribute can contain the FQDN of
the syslog server."
DEFVAL { "H" }
 ::= { docsEqamSyslogServerEntry 3 }

docsEqamSyslogServerEnabled OBJECT-TYPE
SYNTAX TruthValue
MAX-ACCESS read-create
STATUS current
DESCRIPTION
    "Indicates if the syslog server is user for sending syslog messages or is disabled."
DEFVAL { false }
 ::= { docsEqamSyslogServerEntry 4 }

docsEqamSyslogRowStatus OBJECT-TYPE
SYNTAX RowStatus
MAX-ACCESS read-create
STATUS current
DESCRIPTION
    "The status of this instance."
 ::= { docsEqamSyslogServerEntry 5 }

docsEqamRegistrationTable OBJECT-TYPE
SYNTAX SEQUENCE OF DocsEqamRegistrationEntry
MAX-ACCESS not-accessible
STATUS current
DESCRIPTION
    "This object represents the configuration of the ERRP protocol."
 ::= { docsEqamObjects 4 }

docsEqamRegistrationEntry OBJECT-TYPE
SYNTAX DocsEqamRegistrationEntry
MAX-ACCESS not-accessible
STATUS current
```

DESCRIPTION

"The Conceptual row of docsEqamRegistrationTable"

INDEX {

docsEqamRegistrationErmName
}

::= {docsEqamRegistrationTable 1 }

DocsEqamRegistrationEntry ::= SEQUENCE {

docsEqamRegistrationErmName
 SnmpAdminString,
docsEqamRegistrationErmAddressType
 InetAddressType,
docsEqamRegistrationErmAddress
 InetAddress,
docsEqamRegistrationErmPort
 InetPortNumber,
docsEqamRegistrationErmConnectionType
 INTEGER,
docsEqamRegistrationHoldTimer
 Unsigned32,
docsEqamRegistrationConnRetryTimer
 Unsigned32,
docsEqamRegistrationNextHopAddressDomain
 Unsigned32,
docsEqamRegistrationCompAddress
 SnmpAdminString,
docsEqamRegistrationStreamingZone
 SnmpAdminString,
docsEqamRegistrationId
 Unsigned32,
docsEqamRegistrationCost
 Unsigned32,
docsEqamRegistrationCompName
 SnmpAdminString,
docsEqamRegistrationRowStatus
 RowStatus
}

docsEqamRegistrationErmName OBJECT-TYPE

SYNTAX SnmpAdminString

MAX-ACCESS not-accessible

STATUS current

DESCRIPTION

"This key represents the name of the ERM related to this registration instance. This is an internal reference for associating e.g. QAM channels and input interfaces to an ERM."

::= {docsEqamRegistrationEntry 1 }

docsEqamRegistrationErmAddressType OBJECT-TYPE

SYNTAX InetAddressType

MAX-ACCESS read-create

STATUS current

DESCRIPTION

"This attribute represents the InetAddress of the ERM."

DEFVAL { unknown }

::= {docsEqamRegistrationEntry 2 }

docsEqamRegistrationErmAddress OBJECT-TYPE

SYNTAX InetAddress

MAX-ACCESS read-create

STATUS current

DESCRIPTION

"This attribute represents the IP Address of the ERM"

```
DEFVAL { "H }
::= {docsEqamRegistrationEntry 3 }
```

```
docsEqamRegistrationErmPort OBJECT-TYPE
SYNTAX InetPortNumber
MAX-ACCESS read-create
STATUS current
DESCRIPTION
    "This attribute represents the TCP port number used to reach the ERM."
DEFVAL { 0 }
::= {docsEqamRegistrationEntry 4 }
```

```
docsEqamRegistrationErmConnectionType OBJECT-TYPE
SYNTAX INTEGER
    {
        client(1),
        server(2),
        clientAndServer(3)
    }
MAX-ACCESS read-create
STATUS current
DESCRIPTION
    "This attribute represents the type of TCP connection that must be supported by the EQAM. The value can be one of the
following:
```

'client' indicates that the EQAM has to initiate the TCP connection with the ERM.

'server' indicates that the EQAM has to wait the TCP connection from the ERM.

'clientAndServer' indicates that both EQAM or either EQAM or ERM can initiate the TCP connection.

"

```
DEFVAL { client }
::= {docsEqamRegistrationEntry 5 }
```

```
docsEqamRegistrationHoldTimer OBJECT-TYPE
SYNTAX Unsigned32
UNITS "seconds"
MAX-ACCESS read-create
STATUS current
DESCRIPTION
    "This attribute represents the number of seconds that the sender proposes for the value of the hold timer.
```

Upon receipt of an OPEN message, the EQAM MUST calculate the value of the Hold Timer by using the smaller of its configured Hold Time and the Hold Time received in the OPEN message.

The Hold Time MUST be either zero or at least three seconds. An implementation MAY reject connections on the basis of the Hold Time. The calculated value indicates the maximum number of seconds that may elapse between the receipt of successive KEEPALIVE and/or UPDATE messages by the sender."

```
DEFVAL { 3 }
::= {docsEqamRegistrationEntry 6 }
```

```
docsEqamRegistrationConnRetryTimer OBJECT-TYPE
SYNTAX Unsigned32
UNITS "seconds"
MAX-ACCESS read-create
STATUS current
DESCRIPTION
    "This attribute represents the time in seconds for the connect retry timer. The exact value of the connect retry timer is a local
matter, but should be sufficiently large to allow TCP initialization."
DEFVAL { 20 }
::= {docsEqamRegistrationEntry 7 }
```

docsEqamRegistrationNextHopAddressDomain OBJECT-TYPE

SYNTAX Unsigned32
MAX-ACCESS read-create
STATUS current
DESCRIPTION

"This attribute represents the address domain number of the next-hop server. The NextHopServer specifies the address to which a manager should use to connect to the component in order to control the resource specified in the reachable route. This parameter is used in the ERRP NextHopServer attribute."

DEFVAL { 0 }
::= { docsEqamRegistrationEntry 8 }

docsEqamRegistrationCompAddress OBJECT-TYPE

SYNTAX SnmpAdminString
MAX-ACCESS read-create
STATUS current
DESCRIPTION

"This attribute represents the ERRP NextHopServer attribute. This field contains a string that conforms to the following syntax:

CompAddress = host[:port]

host = An FQDN, or an IPv4 address using the textual representation defined in Section 2.1 of [RFC1123], or an IPv6 address using the textual representation defined in Section 2.2 of [RFC4291] and enclosed in '[' and ']' characters.

port = numerical value (1-65535). If the port is empty or not given, the default port 6069 is assumed.

"

DEFVAL { "" }
::= { docsEqamRegistrationEntry 9 }

docsEqamRegistrationStreamingZone OBJECT-TYPE

SYNTAX SnmpAdminString
MAX-ACCESS read-create
STATUS current
DESCRIPTION

"This attribute represents the Streaming Zone within which the component operates.

This parameter is used in the ERRP OPEN message. StreamingZone Name is a mandatory parameter when supporting video applications. The capability is optional when signaling DOCSIS only resources. The value is to be set to the string that represents the StreamingZone Name i.e. <region>.

The characters comprising the string are in the set within TEXT defined in section 15.1 of [RFC2326]. Implementations must support minimum string lengths of 64; however the composition of the string used is defined by implementation agreements specified by the service provider."

DEFVAL { "" }
::= { docsEqamRegistrationEntry 10 }

docsEqamRegistrationId OBJECT-TYPE

SYNTAX Unsigned32
MAX-ACCESS read-create
STATUS current
DESCRIPTION

"This attribute represents the unique identifier for the EQAM device within its Streaming Zone. This value may be set to the 4-octet value of an IPv4 address assigned to that device. This ID value is determined on startup and must be the same for all peer connections. This parameter is used in the ERRP OPEN message header."

DEFVAL { 0 }
::= { docsEqamRegistrationEntry 11 }

docsEqamRegistrationCost OBJECT-TYPE

SYNTAX Unsigned32
MAX-ACCESS read-create
STATUS current
DESCRIPTION

"This attribute represents the static cost for use of this resource."

DEFVAL { 0 }

```
::= { docsEqamRegistrationEntry 12 }
```

docsEqamRegistrationCompName OBJECT-TYPE

SYNTAX SnmpAdminString

MAX-ACCESS read-create

STATUS current

DESCRIPTION

"The name of the component for which the data in the update message applies. This parameter is used in the ERRP OPEN message.

Component Name is a mandatory parameter when supporting video applications. The capability is optional when signaling DOCSIS only resources. The value is to be set to the string that represents the Component Name i.e.

<region>.<localname>

The characters comprising the string are in the set within TEXT defined in section 15.1 of [RFC2326]. Implementations must support minimum string lengths of 64; however the composition of the string used is defined by implementation agreements specified by the service provider.

"

DEFVAL { "" }

```
::= { docsEqamRegistrationEntry 13 }
```

docsEqamRegistrationRowStatus OBJECT-TYPE

SYNTAX RowStatus

MAX-ACCESS read-create

STATUS current

DESCRIPTION

"The status of this instance."

```
::= { docsEqamRegistrationEntry 14 }
```

docsEqamTSInputCfg OBJECT IDENTIFIER ::= { docsEqamObjects 5 }

docsEqamTSInputCfgUnicastSessionLossTimeout OBJECT-TYPE

SYNTAX Unsigned32

UNITS "milliseconds"

MAX-ACCESS read-write

STATUS current

DESCRIPTION

"This attribute represents the loss of signal timeout in milliseconds for unicast input streams. See SCTE-154-4 mpegLossOfSignalTimeout."

DEFVAL { 40 }

```
::= { docsEqamTSInputCfg 1 }
```

docsEqamTSInputCfgMulticastSessionLossTimeout OBJECT-TYPE

SYNTAX Unsigned32

UNITS "milliseconds"

MAX-ACCESS read-write

STATUS current

DESCRIPTION

"This attribute represents the loss of signal timeout in milliseconds for the multicast input streams."

DEFVAL { 40 }

```
::= { docsEqamTSInputCfg 2 }
```

docsEqamTSInputCfgJitterTolerance OBJECT-TYPE

SYNTAX Unsigned32

UNITS "milliseconds"

MAX-ACCESS read-write

STATUS current

DESCRIPTION

"This attribute represents the acceptable delay variation in millisecond for incoming streams. The jitter option sets the size of a dejittering buffer that absorbs the input jitter of a session."

DEFVAL { 40 }

```
::= { docsEqamTSInputCfg 3 }
```

docsEqamTSOutputCfg OBJECT IDENTIFIER ::= { docsEqamObjects 6 }

docsEqamTSOutputCfgCatInsertRate OBJECT-TYPE
 SYNTAX Unsigned32 (0..32)
 UNITS "tables/second"
 MAX-ACCESS read-write

STATUS current
 DESCRIPTION
 "This attribute represents the CAT insertion rate expressed in tables/second (See SCTE-154-4 mpegOutputTSCatInsertRate)."
 DEFVAL { 10 }
 ::= { docsEqamTSOutputCfg 1 }

docsEqamTSOutputCfgPatInsertRate OBJECT-TYPE
 SYNTAX Unsigned32 (0..32)
 UNITS "tables/second"
 MAX-ACCESS read-write

STATUS current
 DESCRIPTION
 "This attribute represents the PAT table interval expressed in tables/second (See SCTE-154-4 mpegOutputTSPatInsertRate)."
 DEFVAL { 10 }
 ::= { docsEqamTSOutputCfg 2 }

docsEqamTSOutputCfgPmtInsertRate OBJECT-TYPE
 SYNTAX Unsigned32 (0..32)
 UNITS "tables/second"
 MAX-ACCESS read-write

STATUS current
 DESCRIPTION
 "This attribute represents the PMT table interval expressed in tables/second (See SCTE-154-4 mpegOutputTSPatInsertRate)."
 DEFVAL { 10 }
 ::= { docsEqamTSOutputCfg 3 }

docsEqamReservedUdpMapTable OBJECT-TYPE
 SYNTAX SEQUENCE OF DocsEqamReservedUdpMapEntry
 MAX-ACCESS not-accessible
 STATUS current
 DESCRIPTION
 "This object represents reserved ports to be used for non-video applications. "
 ::= { docsEqamObjects 7 }

docsEqamReservedUdpMapEntry OBJECT-TYPE
 SYNTAX DocsEqamReservedUdpMapEntry
 MAX-ACCESS not-accessible
 STATUS current
 DESCRIPTION
 "The Conceptual row of docsEqamReservedUdpMapTable"
 INDEX {
 docsEqamReservedUdpMapIndex
 }
 ::= { docsEqamReservedUdpMapTable 1 }

DocsEqamReservedUdpMapEntry ::= SEQUENCE {
 docsEqamReservedUdpMapIndex
 Unsigned32,
 docsEqamReservedUdpMapStartingPort
 Unsigned32,
 docsEqamReservedUdpMapCount

```

        Unsigned32,
docsEqamReservedUdpMapRowStatus
        RowStatus
    }

docsEqamReservedUdpMapIndex OBJECT-TYPE
SYNTAX Unsigned32
MAX-ACCESS not-accessible
STATUS current
DESCRIPTION
    "This key represents the unique identifier of an instance in this object."
 ::= { docsEqamReservedUdpMapEntry 1 }

docsEqamReservedUdpMapStartingPort OBJECT-TYPE
SYNTAX Unsigned32
MAX-ACCESS read-create
STATUS current
DESCRIPTION
    "This attribute represents the port range start value for non-video applications reserved UDP ports. "
DEFVAL { 0 }
 ::= { docsEqamReservedUdpMapEntry 2 }

docsEqamReservedUdpMapCount OBJECT-TYPE
SYNTAX Unsigned32
MAX-ACCESS read-create
STATUS current
DESCRIPTION
    "This attribute represents the number of reserved UDP ports starting from 'StartingPort' attribute value."
DEFVAL { 0 }
 ::= { docsEqamReservedUdpMapEntry 3 }

docsEqamReservedUdpMapRowStatus OBJECT-TYPE
SYNTAX RowStatus
MAX-ACCESS read-create
STATUS current
DESCRIPTION
    "The status of this instance."
 ::= { docsEqamReservedUdpMapEntry 4 }

docsEqamReservedPidRangeTable OBJECT-TYPE
SYNTAX SEQUENCE OF DocsEqamReservedPidRangeEntry
MAX-ACCESS not-accessible
STATUS current
DESCRIPTION
    "This object represents reserved PID range to not be used on ERM assignments. "
 ::= { docsEqamObjects 8 }

docsEqamReservedPidRangeEntry OBJECT-TYPE
SYNTAX DocsEqamReservedPidRangeEntry
MAX-ACCESS not-accessible
STATUS current
DESCRIPTION
    "The Conceptual row of docsEqamReservedPidRangeTable"
INDEX {
    docsEqamReservedPidRangeIndex
}
 ::= { docsEqamReservedPidRangeTable 1 }

DocsEqamReservedPidRangeEntry ::= SEQUENCE {
    docsEqamReservedPidRangeIndex
        Unsigned32,

```

```

docsEqamReservedPidRangeStartingPid
    HePIDValue,
docsEqamReservedPidRangeCount
    Unsigned32,
docsEqamReservedPidRangeDescription
    SnmpAdminString,
docsEqamReservedPidRangeRowStatus
    RowStatus
}

```

```

docsEqamReservedPidRangeIndex OBJECT-TYPE
SYNTAX Unsigned32
MAX-ACCESS not-accessible
STATUS current
DESCRIPTION
    "This key represents the unique identifier of an instance in this object."
 ::= { docsEqamReservedPidRangeEntry 1 }

```

```

docsEqamReservedPidRangeStartingPid OBJECT-TYPE
SYNTAX HePIDValue
MAX-ACCESS read-create
STATUS current
DESCRIPTION
    "This attribute represents the PID range starts for other applications reserved PIDs."
DEFVAL { 0 }
 ::= { docsEqamReservedPidRangeEntry 2 }

```

```

docsEqamReservedPidRangeCount OBJECT-TYPE
SYNTAX Unsigned32
MAX-ACCESS read-create
STATUS current
DESCRIPTION
    "This attribute represents the number of reserved PIDs starting from 'StartingPid' attribute value."
DEFVAL { 0 }
 ::= { docsEqamReservedPidRangeEntry 3 }

```

```

docsEqamReservedPidRangeDescription OBJECT-TYPE
SYNTAX SnmpAdminString
MAX-ACCESS read-create
STATUS current
DESCRIPTION
    "This attribute represents the description associated with a PID range configured instance."
DEFVAL { "" }
 ::= { docsEqamReservedPidRangeEntry 4 }

```

```

docsEqamReservedPidRangeRowStatus OBJECT-TYPE
SYNTAX RowStatus
MAX-ACCESS read-create
STATUS current
DESCRIPTION
    "The status of this instance."
 ::= { docsEqamReservedPidRangeEntry 5 }

```

```
docsEqamDEPICfg OBJECT IDENTIFIER ::= { docsEqamObjects 9 }
```

```

docsEqamDEPICfgDepsessionLossTO OBJECT-TYPE
SYNTAX Unsigned32
UNITS "seconds"
MAX-ACCESS read-write
STATUS current
DESCRIPTION
    "This attribute indicates the Timeout in seconds the EQAM waits after a QAM channel session is terminated to advertize
the QAM channel as idle to the ERM."

```

This attribute is only meaningful for dynamic DEPI session allocation, not for static sessions. "

```
DEFVAL { 0 }
 ::= { docsEqamDEPICfg 1 }
```

docsEqamEdgeInputTable OBJECT-TYPE

```
SYNTAX SEQUENCE OF DocsEqamEdgeInputEntry
MAX-ACCESS not-accessible
STATUS current
DESCRIPTION
 "This object represents the configuration of Input Edge parameters."
 ::= { docsEqamObjects 10 }
```

docsEqamEdgeInputEntry OBJECT-TYPE

```
SYNTAX DocsEqamEdgeInputEntry
MAX-ACCESS not-accessible
STATUS current
DESCRIPTION
 "The Conceptual row of docsEqamEdgeInputTable"
INDEX {
 docsEqamEdgeInputName
 }
 ::= { docsEqamEdgeInputTable 1 }
```

DocsEqamEdgeInputEntry ::= SEQUENCE {

```
 docsEqamEdgeInputName
   SnmpAdminString,
 docsEqamEdgeInputInetAddressType
   InetAddressType,
 docsEqamEdgeInputInetAddress
   InetAddress,
 docsEqamEdgeInputRowStatus
   RowStatus
 }
```

docsEqamEdgeInputName OBJECT-TYPE

```
SYNTAX SnmpAdminString
MAX-ACCESS not-accessible
STATUS current
DESCRIPTION
 "This key represents the Input interface name. This name corresponds to the RFC4133, ENTITY-MIB entPhysicalName."
 ::= { docsEqamEdgeInputEntry 1 }
```

docsEqamEdgeInputInetAddressType OBJECT-TYPE

```
SYNTAX InetAddressType
MAX-ACCESS read-create
STATUS current
DESCRIPTION
 "This attribute represents the IP address type of the 'IpAddress' attribute."
DEFVAL { unknown }
 ::= { docsEqamEdgeInputEntry 2 }
```

docsEqamEdgeInputInetAddress OBJECT-TYPE

```
SYNTAX InetAddress
MAX-ACCESS read-create
STATUS current
DESCRIPTION
 "This attribute represents the IP address of the Edge interface. If not included, the EQAM should use DHCP to acquire the
IP address of the Edge input interface."
DEFVAL { "H }
 ::= { docsEqamEdgeInputEntry 3 }
```

docsEqamEdgeInputRowStatus OBJECT-TYPE

```

SYNTAX    RowStatus
MAX-ACCESS read-create
STATUS    current
DESCRIPTION
    "The status of this instance."
 ::= { docsEqamEdgeInputEntry 4 }

```

```

docsEqamInputRegistrationTable OBJECT-TYPE
SYNTAX    SEQUENCE OF DocsEqamInputRegistrationEntry
MAX-ACCESS not-accessible
STATUS    current
DESCRIPTION
    "This object represents the configuration of Edge ERRP parameters."
 ::= { docsEqamObjects 11 }

```

```

docsEqamInputRegistrationEntry OBJECT-TYPE
SYNTAX    DocsEqamInputRegistrationEntry
MAX-ACCESS not-accessible
STATUS    current
DESCRIPTION
    "The Conceptual row of docsEqamInputRegistrationTable"
INDEX {
    docsEqamEdgeInputName
}
 ::= { docsEqamInputRegistrationTable 1 }

```

```

DocsEqamInputRegistrationEntry ::= SEQUENCE {
    docsEqamInputRegistrationGroupName
        SnmpAdminString,
    docsEqamInputRegistrationBandwidth
        Unsigned32,
    docsEqamInputRegistrationErmName
        SnmpAdminString,
    docsEqamInputRegistrationRowStatus
        RowStatus
}

```

```

docsEqamInputRegistrationGroupName OBJECT-TYPE
SYNTAX    SnmpAdminString
MAX-ACCESS read-create
STATUS    current
DESCRIPTION
    "This attribute represents the name of the Edge Input Group associated with this input. This parameter is used in the ERRP
Edge Input attribute."
DEFVAL { "" }
 ::= { docsEqamInputRegistrationEntry 1 }

```

```

docsEqamInputRegistrationBandwidth OBJECT-TYPE
SYNTAX    Unsigned32
MAX-ACCESS read-create
STATUS    current
DESCRIPTION
    "This attribute represents the bandwidth of the edge input to be advertized. If zero or not present, the EQAM advertize the
full bandwidth of the edge input."
DEFVAL { 0 }
 ::= { docsEqamInputRegistrationEntry 2 }

```

```

docsEqamInputRegistrationErmName OBJECT-TYPE
SYNTAX    SnmpAdminString
MAX-ACCESS read-create
STATUS    current
DESCRIPTION

```

"This attribute represents the ERM where the QAM channel is advertised. If empty, the QAM channel is not advertised. "

```
DEFVAL { "" }
::= { docsEqamInputRegistrationEntry 3 }
```

docsEqamInputRegistrationRowStatus OBJECT-TYPE

```
SYNTAX RowStatus
MAX-ACCESS read-create
STATUS current
DESCRIPTION
  "The status of this instance."
::= { docsEqamInputRegistrationEntry 4 }
```

docsEqamRFPortTable OBJECT-TYPE

```
SYNTAX SEQUENCE OF DocsEqamRFPortEntry
MAX-ACCESS not-accessible
STATUS current
DESCRIPTION
```

"This object represents the configuration of RF ports.

The parameters configured in a RF port applies to all the QAM channels within the RF Port, unless explicit EQAM configuration is defined"

```
::= { docsEqamObjects 12 }
```

docsEqamRFPortEntry OBJECT-TYPE

```
SYNTAX DocsEqamRFPortEntry
MAX-ACCESS not-accessible
STATUS current
DESCRIPTION
  "The Conceptual row of docsEqamRFPortTable"
```

```
INDEX {
  docsEqamRFPortName
}
```

```
::= { docsEqamRFPortTable 1 }
```

DocsEqamRFPortEntry ::= SEQUENCE {

```
  docsEqamRFPortName
    SnmpAdminString,
  docsEqamRFPortAdminStatus
    INTEGER,
  docsEqamRFPortPower
    TenthdBmV,
  docsEqamRFPortFrequency
    Unsigned32,
  docsEqamRFPortModulation
    QAMChannelModulationFormat,
  docsEqamRFPortInterleaverMode
    QAMChannelInterleaveMode,
  docsEqamRFPortInterleaveLevel
    INTEGER,
  docsEqamRFPortAnnex
    INTEGER,
  docsEqamRFPortSpectrumInversion
    TruthValue,
  docsEqamRFPortLockParameters
    BITS,
  docsEqamRFPortCfgNumberChannels
    Unsigned32,
  docsEqamRFPortNumberChannels
    Unsigned32,
  docsEqamRFPortRowStatus
    RowStatus
}
```

docsEqamRFPortName OBJECT-TYPE

SYNTAX SnmpAdminString

MAX-ACCESS not-accessible

STATUS current

DESCRIPTION

"This key represents the RF port identifier. It corresponds to RFC4133, ENTITY-MIB entPhysicalName."

::= { docsEqamRFPortEntry 1 }

docsEqamRFPortAdminStatus OBJECT-TYPE

SYNTAX INTEGER

{
 enabled(1),
 disabled(2)
}

MAX-ACCESS read-only

STATUS current

DESCRIPTION

"This attribute represents the administrative state of the RF Port. Setting this element to 'disable' results in the RF port being muted. By default this element reports 'disabled'."

DEFVAL { enabled }

::= { docsEqamRFPortEntry 2 }

docsEqamRFPortPower OBJECT-TYPE

SYNTAX TenthdBmV

UNITS "TenthdBmV"

MAX-ACCESS read-create

STATUS current

DESCRIPTION

"This attribute represents the power level for the QAM channels in the containment level."

DEFVAL { 0 }

::= { docsEqamRFPortEntry 3 }

docsEqamRFPortFrequency OBJECT-TYPE

SYNTAX Unsigned32

UNITS "Hertz"

MAX-ACCESS read-create

STATUS current

DESCRIPTION

"This attribute represents the first carrier of the configured carriers within the RF port."

DEFVAL { 0 }

::= { docsEqamRFPortEntry 4 }

docsEqamRFPortModulation OBJECT-TYPE

SYNTAX QAMChannelModulationFormat

MAX-ACCESS read-create

STATUS current

DESCRIPTION

"This attribute represents the Modulation type for the QAM channels in the containment level."

DEFVAL { qam256 }

::= { docsEqamRFPortEntry 5 }

docsEqamRFPortInterleaveMode OBJECT-TYPE

SYNTAX QAMChannelInterleaveMode

MAX-ACCESS read-create

STATUS current

DESCRIPTION

"This attribute represents the Interleave mode for the QAM channels in the containment level."

DEFVAL { unknown }

::= { docsEqamRFPortEntry 6 }

docsEqamRFPortInterleaveLevel OBJECT-TYPE

SYNTAX INTEGER

```

        {
            level1(1),
            level(2)
        }
MAX-ACCESS read-create
STATUS current
DESCRIPTION
    "This attribute represents the interleaver level for FEC coding for the QAM channels in the containment level."
DEFVAL { level1 }
::= { docsEqamRFPortEntry 7 }

docsEqamRFPortAnnex OBJECT-TYPE
SYNTAX INTEGER
    {
        unknown(1),
        other(2),
        annexA(3),
        annexB(4),
        annexC(5)
    }
MAX-ACCESS read-create
STATUS current
DESCRIPTION
    "This attribute represents the ITU J.83 Annex mode for the QAM channels in the containment level."
DEFVAL { annexB }
::= { docsEqamRFPortEntry 8 }

docsEqamRFPortSpectrumInversion OBJECT-TYPE
SYNTAX TruthValue
MAX-ACCESS read-create
STATUS current
DESCRIPTION
    "This attribute represents the QAM Signal Spectrum inversion. A value 'true' indicates channel spectrum is inverted."
DEFVAL { false }
::= { docsEqamRFPortEntry 9 }

docsEqamRFPortLockParameters OBJECT-TYPE
SYNTAX BITS
    {
        frequency(0),
        bandwidth(1),
        power(2),
        modulation(3),
        interleaver(4),
        j83Annex(5),
        symbolRate(6),
        mute(7)
    }
MAX-ACCESS read-only
STATUS current
DESCRIPTION
    "This attribute represents the PHY parameters Lock state of the QAM channels n the RF Port containment level for DEPI
initiated PHY parameters updates. This parameter is only required for M-CMTS QAMs."
DEFVAL { "H" }
::= { docsEqamRFPortEntry 10 }

docsEqamRFPortcfgNumberChannels OBJECT-TYPE
SYNTAX Unsigned32
MAX-ACCESS read-create
STATUS current
DESCRIPTION
    "This attribute represents the number of QAM channels to configure in the channel block.
By default all the channels in the RF port are configured."

```

```

 ::= { docsEqamRFPortEntry 11 }

docsEqamRFPortNumberChannels OBJECT-TYPE
    SYNTAX      Unsigned32
    UNITS       "channels"
    MAX-ACCESS  read-only
    STATUS      current
    DESCRIPTION
        "This attribute indicates the total number of QAM channels within the RF."
    ::= { docsEqamRFPortEntry 13 }

docsEqamRFPortRowStatus OBJECT-TYPE
    SYNTAX      RowStatus
    MAX-ACCESS  read-create
    STATUS      current
    DESCRIPTION
        "The status of this instance."
    ::= { docsEqamRFPortEntry 14 }

docsEqamFiberNodeTable OBJECT-TYPE
    SYNTAX      SEQUENCE OF DocsEqamFiberNodeEntry
    MAX-ACCESS  not-accessible
    STATUS      current
    DESCRIPTION
        "This object represents the list of Fiber Nodes the RF port reaches."
    ::= { docsEqamObjects 13 }

docsEqamFiberNodeEntry OBJECT-TYPE
    SYNTAX      DocsEqamFiberNodeEntry
    MAX-ACCESS  not-accessible
    STATUS      current
    DESCRIPTION
        "The Conceptual row of docsEqamFiberNodeTable"
    INDEX {
        docsEqamRFPortName
    }
    ::= { docsEqamFiberNodeTable 1 }

DocsEqamFiberNodeEntry ::= SEQUENCE {
    docsEqamFiberNodeName
        SnmpAdminString,
    docsEqamFiberNodeRowStatus
        RowStatus
}

docsEqamFiberNodeName OBJECT-TYPE
    SYNTAX      SnmpAdminString
    MAX-ACCESS  read-create
    STATUS      current
    DESCRIPTION
        "This attribute represents the Fiber Node Name associated with the RF Port"
    DEFVAL { "" }
    ::= { docsEqamFiberNodeEntry 1 }

docsEqamFiberNodeRowStatus OBJECT-TYPE
    SYNTAX      RowStatus
    MAX-ACCESS  read-create
    STATUS      current
    DESCRIPTION
        "The status of this instance."
    ::= { docsEqamFiberNodeEntry 2 }

docsEqamChannelTable OBJECT-TYPE

```

```
SYNTAX SEQUENCE OF DocsEqamChannelEntry
MAX-ACCESS not-accessible
STATUS current
DESCRIPTION
    "This object represents the configuration of QAM channels."
 ::= { docsEqamObjects 14 }
```

```
docsEqamChannelEntry OBJECT-TYPE
SYNTAX DocsEqamChannelEntry
MAX-ACCESS not-accessible
STATUS current
DESCRIPTION
    "The Conceptual row of docsEqamChannelTable"
INDEX {
    docsEqamChannelPhysName
}
 ::= { docsEqamChannelTable 1 }
```

```
DocsEqamChannelEntry ::= SEQUENCE {
    docsEqamChannelPhysName
        SnmpAdminString,
    docsEqamChannelRFPortPhysName
        SnmpAdminString,
    docsEqamChannelAdminStatus
        INTEGER,
    docsEqamChannelPower
        Unsigned32,
    docsEqamChannelFrequency
        Unsigned32,
    docsEqamChannelModulation
        QAMChannelModulationFormat,
    docsEqamChannelInterleaverMode
        QAMChannelInterleaveMode,
    docsEqamChannelInterleaverLevel
        INTEGER,
    docsEqamChannelAnnex
        INTEGER,
    docsEqamChannelSpectrumInversion
        TruthValue,
    docsEqamChannelName
        SnmpAdminString,
    docsEqamChannelGroupName
        SnmpAdminString,
    docsEqamChannelErmName
        SnmpAdminString,
    docsEqamChannelLockParameters
        BITS,
    docsEqamChannelAllocationType
        INTEGER,
    docsEqamChannelERRPAdvertizing
        TruthValue,
    docsEqamChannelDepiUdpPortMapping
        InetPortNumber,
    docsEqamChannelRowStatus
        RowStatus
}
```

```
docsEqamChannelPhysName OBJECT-TYPE
SYNTAX SnmpAdminString
MAX-ACCESS not-accessible
STATUS current
DESCRIPTION
```

"This key represents the QAM channel identifier. It corresponds to RFC4133, ENTITY-MIB entPhysicalName."
 ::= { docsEqamChannelEntry 1 }

docsEqamChannelRFPortPhysName OBJECT-TYPE

SYNTAX SnmpAdminString
MAX-ACCESS read-create
STATUS current
DESCRIPTION

"This attribute represents the RF port identifier of the QAM channel. It corresponds to RFC4133, ENTITY-MIB entPhysicalName."

DEFVAL { "" }
 ::= { docsEqamChannelEntry 2 }

docsEqamChannelAdminStatus OBJECT-TYPE

SYNTAX INTEGER
{
enabled(1),
disabled(2)
}

MAX-ACCESS read-create
STATUS current
DESCRIPTION

"This attribute represents the administrative state of the QAM channel. Setting this element to 'disable' results in the RF port being muted. By default this element reports 'disabled'."

DEFVAL { enabled }
 ::= { docsEqamChannelEntry 3 }

docsEqamChannelPower OBJECT-TYPE

SYNTAX Unsigned32
UNITS "TenthdBmV"
MAX-ACCESS read-create
STATUS current
DESCRIPTION

"This attribute represents the power level for the QAM channel"

DEFVAL { 0 }
 ::= { docsEqamChannelEntry 4 }

docsEqamChannelFrequency OBJECT-TYPE

SYNTAX Unsigned32
UNITS "Hertz"
MAX-ACCESS read-create
STATUS current
DESCRIPTION

"This attribute represents the carrier frequency of the QAM channel."

DEFVAL { 0 }
 ::= { docsEqamChannelEntry 5 }

docsEqamChannelModulation OBJECT-TYPE

SYNTAX QAMChannelModulationFormat
MAX-ACCESS read-create
STATUS current
DESCRIPTION

"This attribute represents the Modulation type for the QAM channel."

DEFVAL { qam256 }
 ::= { docsEqamChannelEntry 6 }

docsEqamChannelInterleaverMode OBJECT-TYPE

SYNTAX QAMChannelInterleaveMode
MAX-ACCESS read-create
STATUS current
DESCRIPTION

"This attribute represents the Interleave mode of the QAM channel."

DEFVAL { unknown }
::= {docsEqamChannelEntry 7 }

docsEqamChannelInterleaverLevel OBJECT-TYPE

SYNTAX INTEGER

{
 level1(1),
 level(2)
}

MAX-ACCESS read-create

STATUS current

DESCRIPTION

"This attribute represents the interleaver level for FEC coding of the QAM channel."

DEFVAL { level1 }

::= {docsEqamChannelEntry 8 }

docsEqamChannelAnnex OBJECT-TYPE

SYNTAX INTEGER

{
 unknown(1),
 other(2),
 annexA(3),
 annexB(4),
 annexC(5)
}

MAX-ACCESS read-create

STATUS current

DESCRIPTION

"This attribute represents the ITU J.83 Annex mode of the QAM channel."

DEFVAL { annexB }

::= {docsEqamChannelEntry 9 }

docsEqamChannelSpectrumInversion OBJECT-TYPE

SYNTAX TruthValue

MAX-ACCESS read-create

STATUS current

DESCRIPTION

"This attribute represents the QAM Signal Spectrum inversion. A value 'true' indicates channel spectrum is inverted."

DEFVAL { false }

::= {docsEqamChannelEntry 10 }

docsEqamChannelName OBJECT-TYPE

SYNTAX SnmpAdminString

MAX-ACCESS read-create

STATUS current

DESCRIPTION

"This attribute represents the name of the QAM channel. This parameter is used in the ERRP QAM Name attribute."

DEFVAL { "" }

::= {docsEqamChannelEntry 11 }

docsEqamChannelGroupName OBJECT-TYPE

SYNTAX SnmpAdminString

MAX-ACCESS read-create

STATUS current

DESCRIPTION

"This attribute represents the address field in the WithdrawnRoute and ReachableRoutes ERRP attributes. "

DEFVAL { "" }

::= {docsEqamChannelEntry 12 }

docsEqamChannelErmName OBJECT-TYPE

SYNTAX SnmpAdminString

MAX-ACCESS read-create

STATUS current
 DESCRIPTION
 "This attribute represents the ERM where the QAM channel is advertised. If empty, the QAM channel is not advertised."
 DEFVAL { "" }
 ::= {docsEqamChannelEntry 13 }

docsEqamChannelLockParameters OBJECT-TYPE

SYNTAX BITS

```
{
  frequency(0),
  bandwidth(1),
  power(2),
  modulation(3),
  interleaver(4),
  j83Annex(5),
  symbolRate(6),
  mute(7)
}
```

MAX-ACCESS read-create

STATUS current

DESCRIPTION

"This attribute represents the PHY parameters Lock state of the QAM channels for DEPI initiated PHY parameters updates. This parameter is only required for M-CMTS QAMs."

DEFVAL { "H" }

::= {docsEqamChannelEntry 14 }

docsEqamChannelAllocationType OBJECT-TYPE

SYNTAX INTEGER

```
{
  docsisOnly(1),
  videoOnly(2),
  any(3)
}
```

MAX-ACCESS read-create

STATUS current

DESCRIPTION

"This attribute indicates the mechanisms authorized to reserve and control the QAM channels. The possible values are:

'docsisOnly': the QAM channel can be allocated statically or dynamically to DOCSIS.

'videoOnly' the QAM channel can be allocated statically or dynamically to video.

'any' indicates the the QAM channel can be allocated statically or dynamically to video and/or DOCSIS."

DEFVAL { any }

::= {docsEqamChannelEntry 15 }

docsEqamChannelERRPAdvertizing OBJECT-TYPE

SYNTAX TruthValue

MAX-ACCESS read-create

STATUS current

DESCRIPTION

"CM This attribute represents the ERRP advertisement state of the QAM channe.

If set to 'true' the QAM channel is advertised, otherwise is not advertised. This is primarily useful when configuring QAM channels statically and not desire to make the channel part of the ERM channel list. "

DEFVAL { true }

::= {docsEqamChannelEntry 16 }

docsEqamChannelDepiUdpPortMapping OBJECT-TYPE

SYNTAX InetPortNumber

MAX-ACCESS read-create

STATUS current

DESCRIPTION

"This attribute represents the static UDP port assignment for a DEPI UDP tunnel. The value zero indicates there is not static mapping or not applicable."

DEFVAL { 0 }

::= { docsEqamChannelEntry 17 }

docsEqamChannelRowStatus OBJECT-TYPE

SYNTAX RowStatus

MAX-ACCESS read-create

STATUS current

DESCRIPTION

"The status of this instance."

::= { docsEqamChannelEntry 18 }

docsEqamTSOutputTable OBJECT-TYPE

SYNTAX SEQUENCE OF DocsEqamTSOutputEntry

MAX-ACCESS not-accessible

STATUS current

DESCRIPTION

"This object represent transport stream configuration parameters for QAM channels."

::= { docsEqamObjects 15 }

docsEqamTSOutputEntry OBJECT-TYPE

SYNTAX DocsEqamTSOutputEntry

MAX-ACCESS not-accessible

STATUS current

DESCRIPTION

"The Conceptual row of docsEqamTSOutputTable"

INDEX {

docsEqamChannelPhysName

}

::= { docsEqamTSOutputTable 1 }

DocsEqamTSOutputEntry ::= SEQUENCE {

docsEqamTSOutputTSID

Unsigned32,

docsEqamTSOutputNitPid

Unsigned32,

docsEqamTSOutputCaPid

Unsigned32,

docsEqamTSOutputRowStatus

RowStatus

}

docsEqamTSOutputTSID OBJECT-TYPE

SYNTAX Unsigned32

MAX-ACCESS read-create

STATUS current

DESCRIPTION

"This attribute represents the TSID of the output transport stream. See SCTE-154-4 mpegOutputTSTSID.

"

DEFVAL { 0 }

::= { docsEqamTSOutputEntry 1 }

docsEqamTSOutputNitPid OBJECT-TYPE

SYNTAX Unsigned32 (0..255)

MAX-ACCESS read-create

STATUS current

DESCRIPTION

"This attribute represents the NIT PID of the outgoing transport stream. See SCTE-154-4 mpegOutputTSNitPid."

DEFVAL { 0 }

::= { docsEqamTSOutputEntry 2 }

docsEqamTSOutputCaPid OBJECT-TYPE
 SYNTAX Unsigned32 (0..255)
 MAX-ACCESS read-create
 STATUS current
 DESCRIPTION
 "This attribute represents the CA PID of the outgoing transport stream. See SCTE-154-4 mpegOutputTSCaPid."
 DEFVAL { 0 }
 ::= { docsEqamTSOutputEntry 3 }

docsEqamTSOutputRowStatus OBJECT-TYPE
 SYNTAX RowStatus
 MAX-ACCESS read-create
 STATUS current
 DESCRIPTION
 "The status of this instance."
 ::= { docsEqamTSOutputEntry 4 }

docsEqamStaticUdpMapTable OBJECT-TYPE
 SYNTAX SEQUENCE OF DocsEqamStaticUdpMapEntry
 MAX-ACCESS not-accessible
 STATUS current
 DESCRIPTION
 "This object represent the UDP port ranges used for static video sessions."
 ::= { docsEqamObjects 16 }

docsEqamStaticUdpMapEntry OBJECT-TYPE
 SYNTAX DocsEqamStaticUdpMapEntry
 MAX-ACCESS not-accessible
 STATUS current
 DESCRIPTION
 "The Conceptual row of docsEqamStaticUdpMapTable"
 INDEX {
 docsEqamChannelPhysName
 }
 ::= { docsEqamStaticUdpMapTable 1 }

DocsEqamStaticUdpMapEntry ::= SEQUENCE {
 docsEqamStaticUdpMapStartingPort
 Unsigned32,
 docsEqamStaticUdpMapCount
 Unsigned32,
 docsEqamStaticUdpMapRowStatus
 RowStatus
 }

docsEqamStaticUdpMapStartingPort OBJECT-TYPE
 SYNTAX Unsigned32
 MAX-ACCESS read-create
 STATUS current
 DESCRIPTION
 "This attribute represents the UDP port range start value for static session."
 DEFVAL { 0 }
 ::= { docsEqamStaticUdpMapEntry 1 }

docsEqamStaticUdpMapCount OBJECT-TYPE
 SYNTAX Unsigned32
 MAX-ACCESS read-create
 STATUS current
 DESCRIPTION
 "This attribute represents the number of reserved UDP ports starting from 'StartingPort' attribute value."
 DEFVAL { 0 }
 ::= { docsEqamStaticUdpMapEntry 2 }

docsEqamStaticUdpMapRowStatus OBJECT-TYPE

SYNTAX RowStatus
 MAX-ACCESS read-create
 STATUS current
 DESCRIPTION
 "The status of this instance."
 ::= { docsEqamStaticUdpMapEntry 3 }

docsEqamSessionLogCtrl OBJECT IDENTIFIER ::= { docsEqamObjects 17 }

docsEqamSessionLogCtrlMaxSize OBJECT-TYPE

SYNTAX Unsigned32
 UNITS "entries"
 MAX-ACCESS read-write
 STATUS current
 DESCRIPTION
 "This attribute represents the maximum number of mpeg session entries that the 'SessionLog' can report.

Upon a set operation, the lower value between the set value and the supported number of log entries is used."

DEFVAL { 0 }
 ::= { docsEqamSessionLogCtrl 1 }

docsEqamSessionLogCtrlCurrentSize OBJECT-TYPE

SYNTAX Unsigned32
 UNITS "entries"
 MAX-ACCESS read-only
 STATUS current
 DESCRIPTION
 "This attribute represents the current number of mpeg session entries in the 'SessionLog'.
 ::= { docsEqamSessionLogCtrl 2 }

docsEqamSessionLogCtrlAging OBJECT-TYPE

SYNTAX Unsigned32
 UNITS "seconds"
 MAX-ACCESS read-write
 STATUS current
 DESCRIPTION

"This attribute represents the Aging threshold for the 'SessionLog'.
 Periodically, a process scans through 'SessionLog' and removes those sessions that have a 'SessionLog::StopTime' greater than this threshold in minutes. A value of 0 means no aging out log entries."

DEFVAL { 10080 }
 ::= { docsEqamSessionLogCtrl 3 }

docsEqamSessionLogCtrlClearAll OBJECT-TYPE

SYNTAX TruthValue
 MAX-ACCESS read-write
 STATUS current
 DESCRIPTION
 "This attribute provides a control to clear the 'Session log'.

If set to 'true', all entries from the 'SessionLog' object are removed. Reading this attribute always returns 'false'."

DEFVAL { false }
 ::= { docsEqamSessionLogCtrl 4 }

docsEqamSessionLogCtrlType OBJECT-TYPE

SYNTAX INTEGER
 {
 allSessions(1),
 sessionsWithExceptions(2)
 }
 MAX-ACCESS read-write
 STATUS current
 DESCRIPTION

"This attribute indicates which type of videos sessions are reported in the 'SessionLog' object.

The value 'allSessions' indicates all video sessions are reported in the 'SessionLog'

The value 'sessionsWithExceptions' indicates that video sessions are reported when either of the conditions below occur:

- The Continuity Errors or Synch Loss Packets of the associated session is greater than zero.
- The Dropped packets, FIFO Overflow or FIFO Underflow is greater than zero."

DEFVAL { sessionsWithExceptions }
 ::= { docsEqamSessionLogCtrl 5 }

docsEqamSessionLogTable OBJECT-TYPE

SYNTAX SEQUENCE OF DocsEqamSessionLogEntry
 MAX-ACCESS not-accessible
 STATUS current
 DESCRIPTION

"This object represent the list of terminated MPEG video sessions.

All parameters values reported for a session are determined at the time of the session deletion."

::= { docsEqamObjects 18 }

docsEqamSessionLogEntry OBJECT-TYPE

SYNTAX DocsEqamSessionLogEntry
 MAX-ACCESS not-accessible
 STATUS current
 DESCRIPTION

"The Conceptual row of docsEqamSessionLogTable"

INDEX {
 docsEqamSessionLogIndex
 }

::= { docsEqamSessionLogTable 1 }

DocsEqamSessionLogEntry ::= SEQUENCE {

 docsEqamSessionLogIndex
 Unsigned32,
 docsEqamSessionLogId
 Unsigned32,
 docsEqamSessionLogInputIfIndex
 InterfaceIndex,
 docsEqamSessionLogOutputIfIndex
 InterfaceIndex,
 docsEqamSessionLogInputContinuityErrors
 Counter32,
 docsEqamSessionLogInputSyncLossPkts
 Counter32,
 docsEqamSessionLogOutputTotalPkts
 Counter64,
 docsEqamSessionLogOutputDroppedPkts
 Counter32,
 docsEqamSessionLogOutputFifoOverflow
 Counter32,
 docsEqamSessionLogOutputFifoUnderflow
 Counter32,
 docsEqamSessionLogMode
 INTEGER,
 docsEqamSessionLogStartTime
 DateAndTime,
 docsEqamSessionLogStopTime
 DateAndTime,
 docsEqamSessionLogInputAddrType
 InetAddressType,
 docsEqamSessionLogInputSrcInetAddress
 InetAddress,
 docsEqamSessionLogInputSrcPort

```

    InetPortNumber,
docsEqamSessionLogInputDstInetAddr
    InetAddress,
docsEqamSessionLogInputDstPort
    InetPortNumber
}

```

docsEqamSessionLogIndex OBJECT-TYPE

```

SYNTAX Unsigned32
MAX-ACCESS not-accessible
STATUS current
DESCRIPTION

```

"This key represents the unique identifier of an instance in this object.

This attribute's behavior consist of an incremental value. If the maximum number of instances is reached the log instance with the lower key value is deleted and the new instance is added."

```
 ::= {docsEqamSessionLogEntry 1 }
```

docsEqamSessionLogId OBJECT-TYPE

```

SYNTAX Unsigned32
MAX-ACCESS read-only
STATUS current
DESCRIPTION

```

"This attribute identifies the MPEG Session Id of this entry."

```
 ::= {docsEqamSessionLogEntry 2 }
```

docsEqamSessionLogInputIfIndex OBJECT-TYPE

```

SYNTAX InterfaceIndex
MAX-ACCESS read-only
STATUS current
DESCRIPTION

```

"This attribute identifies the interface index of the mpeg source stream."

```
 ::= {docsEqamSessionLogEntry 3 }
```

docsEqamSessionLogOutputIfIndex OBJECT-TYPE

```

SYNTAX InterfaceIndex
MAX-ACCESS read-only
STATUS current
DESCRIPTION

```

"This attribute identifies the interface index of the mpeg output stream."

```
 ::= {docsEqamSessionLogEntry 4 }
```

docsEqamSessionLogInputContinuityErrors OBJECT-TYPE

```

SYNTAX Counter32
UNITS "errors"
MAX-ACCESS read-only
STATUS current
DESCRIPTION

```

"This attribute indicates the total number of continuity counter errors for the session. See SCTE154-4 mpegInputStatsContinuityErrors for details of the count definition."

```
 ::= {docsEqamSessionLogEntry 5 }
```

docsEqamSessionLogInputSyncLossPkts OBJECT-TYPE

```

SYNTAX Counter32
UNITS "packets"
MAX-ACCESS read-only
STATUS current
DESCRIPTION

```

"This attribute indicates the total number of MPEG packets that had missing sync byte for the session. See SCTE 154-4 mpgInputStatsSyncLossPackets for details of the count definition."

```
 ::= {docsEqamSessionLogEntry 6 }
```

docsEqamSessionLogOutputTotalPkts OBJECT-TYPE

SYNTAX Counter64
UNITS "packets"
MAX-ACCESS read-only
STATUS current
DESCRIPTION
"This attribute indicates the total number of MPEG output packets for the session."
::= {docsEqamSessionLogEntry 7 }

docsEqamSessionLogOutputDroppedPkts OBJECT-TYPE
SYNTAX Counter32
UNITS "packets"
MAX-ACCESS read-only
STATUS current
DESCRIPTION
"This attribute indicates the total number of MPEG output packets dropped for the session."
::= {docsEqamSessionLogEntry 8 }

docsEqamSessionLogOutputFifoOverflow OBJECT-TYPE
SYNTAX Counter32
UNITS "overflows"
MAX-ACCESS read-only
STATUS current
DESCRIPTION
"This attribute indicates the total number of FIFO overflows of the session."
::= {docsEqamSessionLogEntry 9 }

docsEqamSessionLogOutputFifoUnderflow OBJECT-TYPE
SYNTAX Counter32
UNITS "underflows"
MAX-ACCESS read-only
STATUS current
DESCRIPTION
"This attribute indicates the total number of FIFO underflows of the session."
::= {docsEqamSessionLogEntry 10 }

docsEqamSessionLogMode OBJECT-TYPE
SYNTAX INTEGER
{
 other(1),
 passThrough(2),
 multiplexing(3)
}
MAX-ACCESS read-only
STATUS current
DESCRIPTION
"This attribute indicates the type of session. See SCTE 154-4 docsQamVideoSessionMode for definitions of the type of sessions."
::= {docsEqamSessionLogEntry 11 }

docsEqamSessionLogStartTime OBJECT-TYPE
SYNTAX DateAndTime
MAX-ACCESS read-only
STATUS current
DESCRIPTION
"This attribute indicates the date and time when the session was setup."
::= {docsEqamSessionLogEntry 12 }

docsEqamSessionLogStopTime OBJECT-TYPE
SYNTAX DateAndTime
MAX-ACCESS read-only
STATUS current
DESCRIPTION

```

    "This attribute indicates the date and time when the session was deleted."
    ::= { docsEqamSessionLogEntry 13 }

docsEqamSessionLogInputAddrType OBJECT-TYPE
    SYNTAX      InetAddressType
    MAX-ACCESS  read-only
    STATUS      current
    DESCRIPTION
        "This attribute indicates the address type associated with the input transport stream of the session. The value 'unknown'
        indicates no IP transport associated to the transport stream. The value 'dns' is not used."
    ::= { docsEqamSessionLogEntry 14 }

docsEqamSessionLogInputSrcInetAddr OBJECT-TYPE
    SYNTAX      InetAddress
    MAX-ACCESS  read-only
    STATUS      current
    DESCRIPTION
        "This attribute indicates the source address of the IP flow contained in the session.
        For Multicast it represents the Source Specific Multicast IP Address of the UDP IP flow.
        For unicast UDP IP flows is either the value 0.0.0.0 if the IP source address is unknown or irrelevant for the origination transport
        stream."
    ::= { docsEqamSessionLogEntry 15 }

docsEqamSessionLogInputSrcPort OBJECT-TYPE
    SYNTAX      InetPortNumber
    MAX-ACCESS  read-only
    STATUS      current
    DESCRIPTION
        "This attribute indicates the source port of the UDP IP flow of the input transport stream."
    ::= { docsEqamSessionLogEntry 16 }

docsEqamSessionLogInputDstInetAddr OBJECT-TYPE
    SYNTAX      InetAddress
    MAX-ACCESS  read-only
    STATUS      current
    DESCRIPTION
        "This attribute indicates the destination address of the IP flow contained in the session.
        For multicast it represents the group address of the SSM origination input TS. For unicast UDP IP flows is either the value
        0.0.0.0 if the IP destination address is unknown or irrelevant for the origination input stream."
    ::= { docsEqamSessionLogEntry 17 }

docsEqamSessionLogInputDstPort OBJECT-TYPE
    SYNTAX      InetPortNumber
    MAX-ACCESS  read-only
    STATUS      current
    DESCRIPTION
        "This attribute indicates the UDP destination port of the UDP IP flow of the input transport stream."
    ::= { docsEqamSessionLogEntry 18 }

-- Conformance Definitions
docsEqamMibConformance OBJECT IDENTIFIER ::= { docsEqamMib 2 }
docsEqamMibCompliances OBJECT IDENTIFIER ::= { docsEqamMibConformance 1 }
docsEqamMibGroups OBJECT IDENTIFIER ::= { docsEqamMibConformance 2 }

docsEqamFullCompliance MODULE-COMPLIANCE
    STATUS      current
    DESCRIPTION
        "The compliance statement for the full implementation of
        the MIB Module."
    MODULE -- this MODULE
    MANDATORY-GROUPS {
        docsEqamGroup

```

```

    }
    ::= { docsEqamMibCompliances 1 }

```

```
docsEqamFullCompliance MODULE-COMPLIANCE
```

```
STATUS current
```

```
DESCRIPTION
```

```
"The compliance statement for the read-only implementation of
the MIB Module."
```

```
MODULE -- this MODULE
```

```
MANDATORY-GROUPS {
```

```
docsEqamReadGroup
```

```
}
```

```
::= { docsEqamMibCompliances 2 }
```

```
docsEqamReadGroup OBJECT-GROUP
```

```
OBJECTS {
```

```
docsEqamControlReset,
docsEqamControlInitCause,
docsEqamControlSaveCfg,
docsEqamControlUploadCfg,
docsEqamSessionLogId,
docsEqamSessionLogInputIfIndex,
docsEqamSessionLogOutputIfIndex,
docsEqamSessionLogInputContinuityErrors,
docsEqamSessionLogInputSyncLossPkts,
docsEqamSessionLogOutputTotalPkts,
docsEqamSessionLogOutputDroppedPkts,
docsEqamSessionLogOutputFifoOverflow,
docsEqamSessionLogOutputFifoUnderflow,
docsEqamSessionLogMode,
docsEqamSessionLogStartTime,
docsEqamSessionLogStopTime,
docsEqamSessionLogInputAddrType,
docsEqamSessionLogInputSrcInetAddr,
docsEqamSessionLogInputSrcPort,
docsEqamSessionLogInputDstInetAddr,
docsEqamSessionLogInputDstPort,
docsEqamNotifyMgmtInetAddressType,
docsEqamNotifyMgmtInetAddress,
docsEqamSessionLogCtrlMaxSize,
docsEqamSessionLogCtrlCurrentSize,
docsEqamSessionLogCtrlAging,
docsEqamSessionLogCtrlClearAll,
docsEqamSessionLogCtrlType,
docsEqamTimeNtpMaster,
docsEqamTimeNtpBackup,
docsEqamTimeTimeZone,
docsEqamTimeDaylightSaving,
docsEqamSyslogServer,
docsEqamSyslogServerInetAddressType,
docsEqamSyslogServerInetAddress,
docsEqamSyslogServerEnabled,
docsEqamSyslogRowStatus,
docsEqamRegistrationErmAddressType,
docsEqamRegistrationErmAddress,
docsEqamRegistrationErmPort,
docsEqamRegistrationErmConnectionType,
docsEqamRegistrationHoldTimer,
docsEqamRegistrationConnRetryTimer,
docsEqamRegistrationNextHopAddressDomain,
docsEqamRegistrationCompAddress,
docsEqamRegistrationStreamingZone,
```

docsEqamRegistrationId,
docsEqamRegistrationCost,
docsEqamRegistrationCompName,
docsEqamRegistrationRowStatus,
docsEqamTSOutputCfgCatInsertRate,
docsEqamTSOutputCfgPatInsertRate,
docsEqamTSOutputCfgPmtInsertRate,
docsEqamTSInputCfgUnicastSessionLossTimeout,
docsEqamTSInputCfgMulticastSessionLossTimeout,
docsEqamTSInputCfgJitterTolerance,
docsEqamReservedUdpMapStartingPort,
docsEqamReservedUdpMapCount,
docsEqamReservedUdpMapRowStatus,
docsEqamReservedPidRangeStartingPid,
docsEqamReservedPidRangeCount,
docsEqamReservedPidRangeDescription,
docsEqamReservedPidRangeRowStatus,
docsEqamEdgeInputInetAddressType,
docsEqamEdgeInputInetAddress,
docsEqamEdgeInputRowStatus,
docsEqamInputRegistrationGroupName,
docsEqamInputRegistrationBandwidth,
docsEqamInputRegistrationErmName,
docsEqamInputRegistrationRowStatus,
docsEqamRFPortAdminStatus,
docsEqamRFPortPower,
docsEqamRFPortFrequency,
docsEqamRFPortModulation,
docsEqamRFPortInterleaverMode,
docsEqamRFPortInterleaveLevel,
docsEqamRFPortAnnex,
docsEqamRFPortSpectrumInversion,
docsEqamRFPortLockParameters,
docsEqamRFPortcfgNumberChannels,
docsEqamRFPortNumberChannels,
docsEqamRFPortRowStatus,
docsEqamFiberNodeName,
docsEqamFiberNodeRowStatus,
docsEqamChannelRFPortPhysName,
docsEqamChannelAdminStatus,
docsEqamChannelPower,
docsEqamChannelFrequency,
docsEqamChannelModulation,
docsEqamChannelInterleaverMode,
docsEqamChannelInterleaverLevel,
docsEqamChannelAnnex,
docsEqamChannelSpectrumInversion,
docsEqamChannelName,
docsEqamChannelGroupName,
docsEqamChannelErmName,
docsEqamChannelLockParameters,
docsEqamChannelAllocationType,
docsEqamChannelERRPAdvertizing,
docsEqamChannelDepiUdpPortMapping,
docsEqamChannelRowStatus,
docsEqamDEPICfgDepiSessionLossTO,
docsEqamTSOutputTSID,
docsEqamTSOutputNitPid,
docsEqamTSOutputCaPid,
docsEqamTSOutputRowStatus,
docsEqamStaticUdpMapStartingPort,
docsEqamStaticUdpMapCount,

```

    docsEqamStaticUdpMapRowStatus
}
STATUS    current
DESCRIPTION
    "Group of objects for the full implementation
    of the MIB module."
 ::= { docsEqamGroups 1 }

```

docsEqamReadGroup OBJECT-GROUP

```

OBJECTS {
    docsEqamControlReset,
    docsEqamControlInitCause,
    docsEqamControlSaveCfg,
    docsEqamControlUploadCfg,
    docsEqamSessionLogId,
    docsEqamSessionLogInputIfIndex,
    docsEqamSessionLogOutputIfIndex,
    docsEqamSessionLogInputContinuityErrors,
    docsEqamSessionLogInputSyncLossPkts,
    docsEqamSessionLogOutputTotalPkts,
    docsEqamSessionLogOutputDroppedPkts,
    docsEqamSessionLogOutputFifoOverflow,
    docsEqamSessionLogOutputFifoUnderflow,
    docsEqamSessionLogMode,
    docsEqamSessionLogStartTime,
    docsEqamSessionLogStopTime,
    docsEqamSessionLogInputAddrType,
    docsEqamSessionLogInputSrcInetAddr,
    docsEqamSessionLogInputSrcPort,
    docsEqamSessionLogInputDstInetAddr,
    docsEqamSessionLogInputDstPort,
    docsEqamNotifyMgmtInetAddressType,
    docsEqamNotifyMgmtInetAddress,
    docsEqamSessionLogCtrlMaxSize,
    docsEqamSessionLogCtrlCurrentSize,
    docsEqamSessionLogCtrlAging,
    docsEqamSessionLogCtrlClearAll,
    docsEqamSessionLogCtrlType,
    docsEqamTimeNtpMaster,
    docsEqamTimeNtpBackup,
    docsEqamTimeTimeZone,
    docsEqamTimeDaylightSaving,
    docsEqamSyslogServer,
    docsEqamSyslogServerInetAddressType,
    docsEqamSyslogServerInetAddress,
    docsEqamSyslogServerEnabled,
    docsEqamRegistrationErmAddressType,
    docsEqamRegistrationErmAddress,
    docsEqamRegistrationErmPort,
    docsEqamRegistrationErmConnectionType,
    docsEqamRegistrationHoldTimer,
    docsEqamRegistrationConnRetryTimer,
    docsEqamRegistrationNextHopAddressDomain,
    docsEqamRegistrationCompAddress,
    docsEqamRegistrationStreamingZone,
    docsEqamRegistrationId,
    docsEqamRegistrationCost,
    docsEqamRegistrationCompName,
    docsEqamTSOutputCfgCatInsertRate,
    docsEqamTSOutputCfgPatInsertRate,
    docsEqamTSOutputCfgPmtInsertRate,
    docsEqamTSInputCfgUnicastSessionLossTimeout,

```

```

docsEqamTSInputCfgMulticastSessionLossTimeout,
docsEqamTSInputCfgJitterTolerance,
docsEqamReservedUdpMapStartingPort,
docsEqamReservedUdpMapCount,
docsEqamReservedPidRangeStartingPid,
docsEqamReservedPidRangeCount,
docsEqamReservedPidRangeDescription,
docsEqamEdgeInputInetAddressType,
docsEqamEdgeInputInetAddress,
docsEqamInputRegistrationGroupName,
docsEqamInputRegistrationBandwidth,
docsEqamInputRegistrationErmName,
docsEqamRFPortAdminStatus,
docsEqamRFPortPower,
docsEqamRFPortFrequency,
docsEqamRFPortModulation,
docsEqamRFPortInterleaverMode,
docsEqamRFPortInterleaveLevel,
docsEqamRFPortAnnex,
docsEqamRFPortSpectrumInversion,
docsEqamRFPortLockParameters,
docsEqamRFPortcfgNumberChannels,
docsEqamRFPortNumberChannels,
docsEqamFiberNodeName,
docsEqamChannelRFPortPhysName,
docsEqamChannelAdminStatus,
docsEqamChannelPower,
docsEqamChannelFrequency,
docsEqamChannelModulation,
docsEqamChannelInterleaverMode,
docsEqamChannelInterleaverLevel,
docsEqamChannelAnnex,
docsEqamChannelSpectrumInversion,
docsEqamChannelName,
docsEqamChannelGroupName,
docsEqamChannelErmName,
docsEqamChannelLockParameters,
docsEqamChannelAllocationType,
docsEqamChannelERRPAdvertizing,
docsEqamChannelDepiUdpPortMapping,
docsEqamDEPICfgDepiSessionLossTO,
docsEqamTSOutputTSID,
docsEqamTSOutputNitPid,
docsEqamTSOutputCaPid,
docsEqamStaticUdpMapStartingPort,
docsEqamStaticUdpMapCount
}
STATUS current
DESCRIPTION
  "Group of objects for the read-only implementation
  of the MIB module."
 ::= { docsEqamGroups 2 }

END

```

