

VOLUME 1 NO. 1 JUNE 2021

# SCTE TECHNICAL JOURNAL

# SCTE TECHNICAL JOURNAL

**VOLUME 1, NUMBER 1**

**June 2021**

Society of Cable Telecommunications Engineers, Inc.  
140 Philips Road, Exton, PA 19341-1318

© 2021 by the Society of Cable Telecommunications Engineers, Inc. All rights reserved.

As compiled, arranged, modified, enhanced and edited, all license works and other separately owned materials contained in this publication are subject to foregoing copyright notice. No part of this journal shall be reproduced, stored in a retrieval system or transmitted by any means, electronic, mechanical, photocopying, recording or otherwise, without written permission from the Society of Cable Telecommunications Engineers, Inc. No patent liability is assumed with respect to the use of the information contained herein. While every precaution has been taken in the preparation of the publication, SCTE assumes no responsibility for errors or omissions. Neither is any liability assumed for damages resulting from the use of the information contained herein.

# Table of Contents

4	<b>From the Staff</b>
5	<b>Performance Estimation of FDX Cable Networks</b> Jun Wang, Principal Hardware Design Engineer, CommScope Ayham Al-Banna, Director of Business Development & Fellow, CommScope
23	<b>Access Network Powering</b> Rob Anderson, Director of Product Management, EnerSys
38	<b>GAP and the Future Of Telecom Networks</b> Bill Beesley, Chief Architect, MSO Strategy and Planning, Fujitsu
47	<b>Cable Operator Operational Considerations To Reach 10G Access Networks</b> Dr. Sudheer Dharanikota, Managing Director, Duke Tech Solutions Inc. Dr. Luc Absillis, Chief Operating Officer, First Principles Innovations LLC Rajesh Abbi, Principal Consultant, Duke Tech Solutions Inc.
68	<b>Adaptive Wi-Fi – The network optimization standard</b> Adam Hotchkiss, Co-Founder, VP Product, Plume Design, Inc. Bill McFarland, Chief Technology Officer, Plume Design, Inc.
78	<b>Aging in Place Business Case for Cable Operators</b> Dr. Sudheer Dharanikota, Managing Director, Duke Tech Solutions Inc. Ayarah Dharanikota, Healthcare Strategy Consultant, Duke Tech Solutions Inc. Dennis Edens, Senior Manager, Duke Tech Solutions Inc. Bruce McLeod, Executive Director, Cox Communications
98	<b>Aging in Place Market Landscape from a Cable Operators Perspective</b> Dr. Sudheer Dharanikota, Managing Director, Duke Tech Solutions Inc. Ayarah Dharanikota, Healthcare Strategy Consultant, Duke Tech Solutions Inc. Dennis Edens, Senior Manager, Duke Tech Solutions Inc. Bruce McLeod, Executive Director, Cox Communications
122	<b>Achieve Power Savings in a DOCSIS 4.0 network with a Distributed Gain Architecture</b> Jan Ariesen, Chief Technology Officer, Technetix BV

**SCTE Engineering Committee  
Chair and Data Standards  
Subcommittee (DSS) Chair:**  
**David Fellows,**  
SCTE Member

**Senior Editor**  
**Paul Schneider**  
Paul Schneider Public Relations

**Publications Staff**  
**Chris Bastian**  
SVP & Chief Technology Officer,  
SCTE

**Dean Stoneback**  
Senior Director, Engineering &  
Standards, SCTE

**Kim Cooney**  
Technical Editor, SCTE

**Editorial Correspondence:** If there are errors or omissions to the information provided in this journal, corrections may be sent to our editorial department. Address to: SCTE Journals, SCTE, 140 Philips Road, Exton, PA 19341-1318 or email [journals@scte.org](mailto:journals@scte.org).

**Submissions:** If you have ideas or topics for future journal articles, please let us know. All submissions will be peer reviewed and published at the discretion of SCTE. Electronic submissions are preferred, and should be submitted to SCTE Journals, [journals@scte.org](mailto:journals@scte.org).

## From the Staff

What a year it's been – both for SCTE and our industry!

Just as cable has evolved how it meets the needs of subscribers – particularly during the pandemic – so too has SCTE changed ahead of landscape shifts. The growth of our SCTE Standards [Explorer](#) initiative, our introduction of virtual formats to [SCTE Cable-Tec Expo](#) and our [merger](#) with CableLabs all have broadened the reach of the Society and the scope of opportunities available to our members.

At the same time, we've rethought how we communicate and share knowledge with the industry, particularly those who are participants in the Standards Program. This first 2021 edition of the SCTE Standards [Journal](#) begins a new era for our flagship publications, consolidating the Digital Video, Energy Management and Network Operations technical journals of the past – and more – into a single quarterly volume.

Here's what drove our thinking: While the concept of journals dedicated to different sectors of the industry had value, we heard from many of you who sought an alternative approach that would help you stay abreast of the fast pace of cable innovation. In addition, there was a need to accommodate the vast universe of new Explorer categories – such as telehealth and aging in place; telemedicine; artificial intelligence and machine learning; smart cities; and extending spectrum up to 3.0 GHz.

By addressing a wide variety of topic areas each quarter, we'll be able more quickly to deliver ideation that will make our industry better. And by removing the bounds of our three journal categories, we can expand the subject matter to literally any technology issue.

In our first edition, we've got:

- Multiple articles on the implications of 10G and advanced DOCSIS, including architectural, powering and operational considerations.
- The business and market cases for cable's rollout of solutions that support aging-in-place services for a graying population.
- Applications and use cases that will take SCTE's imminent GAP standard from cost reduction to revenue enhancement.
- Adaptive Wi-Fi technologies that can shift the focus of wireless performance to the quality of the customer experience.

We hope you enjoy this inaugural edition, and we look forward to your feedback. I'd also ask that you consider submitting an article of your own for an upcoming issue. A major factor in cable's strength has been the willingness of the technology community to share ideas that can drive industry-wide progress, so please keep your eyes peeled for our next Call for Papers.

One final reminder: while these journals are important cogs in the transfer of knowledge, there is no better single venue for growing your career in our industry than [SCTE Cable-Tec Expo](#). I encourage you to be with us when we return to an in-person show, with virtual elements, Oct. 11-14 in Atlanta.

Thanks for reading and for being a part of [SCTE](#). We're grateful for your help as we work to take our industry to new heights!

Chris Bastian  
SVP & Chief Technology Officer, SCTE

# Performance Estimation of FDX Cable Networks

A Technical Paper prepared for SCTE by

Jun Wang, Principal Hardware Design Engineer,  
CommScope, SCTE Member  
2400 Ogden Ave, Suite 180  
Lisle, IL 60532  
Jun.wang2@commscope.com  
215-323-2293

Ayham Al-Banna, Director of Business Development & Fellow  
CommScope, SCTE Member  
2400 Ogden Ave, Suite 180  
Lisle, IL 60532  
ayham.al-banna@commscope.com  
630-281-3009

## Table of Contents

Title	Page Number
Table of Contents	6
1. Introduction	7
1.1. Technology Review	7
1.2. Summary	8
2. Theoretical Analysis	9
2.1. CCI Due to Reflected Downstream Signal Back to the Node	9
2.2. CCI Due to CM-to-CM Interference	12
2.3. Interference Between CMs Connected to the Same Tap	16
3. Building Blocks for Cable Network Modelling	16
4. Application	19
5. Conclusion	21
6. Acknowledgement	21
7. Abbreviations	21
8. References	22

## List of Figures

Title	Page Number
Figure 1 - A node+0 FDX network with notations of parameters used in Equation (1).	9
Figure 2 - An example of an FDX cable plant.	11
Figure 3 - The power reflection coefficient of the cable plant in Figure 2. (a) the calculated result ; (b) the measured result.	12
Figure 4 - A node+0 FDX network with notations of parameters used in Equation (6), (10), and (11).	13
Figure 5 - CM-to-CM interference coefficient, calculated results.	14
Figure 6 - CM-to-CM interference coefficient, measured results.	15
Figure 7 - Comparison of calculated and measured S2P-parameters ((a)-(b)) of the assembled 2nd tap and measured S2P-parameters with and without the CS ((c)-(f)) of the 2nd tap: (a) tap input to a tap port $S_{21}$ ; (b) tap output to a tap port $S_{21}$ ; (c) tap through-path $S_{21}$ ; (d) tap input $S_{11}$ ; (e) tap output $S_{22}$ ; (f) tap port $S_{22}$ .	17
Figure 8 - Comparison of calculated and measured S2P-parameters ((a)-(b)) of the assembled 5th tap and measured S2P-parameters with and without the EQ ((c)-(f)) of the 5th tap: (a) tap input to a tap port $S_{21}$ ; (b) tap output to a tap port $S_{21}$ ; (c) tap through-path $S_{21}$ ; (d) tap input $S_{11}$ ; (e) tap output $S_{22}$ ; (f) tap port $S_{22}$ .	18
Figure 9 - Comparison of S2P-parameters of FTT26-8 with different pluggable components: (a) measured phases of input $S_{11}$ ; (b) measured phases of tap output $S_{22}$ ; (c) measured phases of a tap port $S_{22}$ ; (d) measured phases of tap through $S_{21}$ ; (e) measured phase of tap output to a tap port $S_{21}$ .	19
Figure 10 - SNR at the node receiver for US signals from different taps.	21

# 1. Introduction

## 1.1. Technology Review

The cable television industry is moving to new technologies that enable and provide the larger upstream (US) and downstream (DS) capacity needed for multi-gigabit symmetrical or asymmetrical services, when compared to traditional hybrid fiber/coax (HFC) networks. This increased capacity addresses the consistent growth in demand for bandwidth year over year for different applications, e.g., high-definition video streaming, smart home applications, gaming, Internet of Things (IoT), and 5G, etc. One of the leading technologies is full duplex (FDX) DOCSIS, as specified in the appendix to DOCSIS 3.1[1] as well as in DOCSIS 4.0[2]. The new technologies also evolved from a legacy centralized access architecture (CAA) to a distributed access architecture (DAA), where analog optical transmission is replaced by Ethernet digital optical transmission. Partial functions/devices of a cable modem termination system (CMTS) are moved from a headend or hub site to remote nodes in the form of either remote PHY (R-PHY) devices, i.e., RPDs, or remote MAC+PHY devices, i.e., RMDs. Unlike traditional DOCSIS 3.0 technology – in which the upstream signals and downstream signals are transmitted over their own RF spectrum dedicated for each transmission direction, commonly referred to as frequency division duplex (FDD) – FDX uses the same block of bandwidth for both upstream and downstream signals at a given time, therefore significantly increasing both the bandwidth efficiency and the RF bandwidth of the upstream signals. The key enabling technologies that support FDX are R-PHY, OFDM modulation, echo cancellation and smart bandwidth assignment. The DOCSIS 4.0 specification was released early in 2020. OFDM modulation, together with the coding gain from the newer error correction mechanisms, reduces the required receiver modulation error ratio (RxMER) for the same QAM order, as compared to the case in single carrier QAM with the legacy forward error correction mechanism, and allows the modulation of higher QAM orders. OFDM also allows flexible channel and QAM order assignments based on transmission qualities. In the meantime, R-PHY together with digital optics improve signal quality which also opens the door for higher order QAM modulation.

The FDX band occupies a subset of a cable network’s RF spectrum, specifically 108 MHz to 684 MHz. This bandwidth supports three OFDM downstream channels with each being 192 MHz wide or six OFDMA upstream channels with each being 96 MHz wide. Namely, each downstream OFDM channel bandwidth contains two upstream OFDMA channels’ bandwidth, which is also noted as sub-band. From the CMTS or node perspective, traffic simultaneously flows upstream and downstream in the same sub-bands of the FDX band. From the cable modem (CM) perspective, the spectrum still uses FDD, i.e., each CM will use one set of sub-bands only for upstream operation and another set of sub-bands only for downstream operation at a given time. While one group of CMs uses one set of sub-bands for upstream transmission, a different group of CMs can receive the downstream signal simultaneously in the same set of sub-bands, realizing FDX. The operation of a group of CMs in an FDX band for either US or DS can be switched by a resource block assignment (RBA) function inside the CMTS [3]. Since both transmitting and receiving at the same time in the same sub-bands are seen by an FDX node, the node must use echo cancellation (EC) techniques to eliminate interfering noise[4], i.e., downstream signals reflected or echoed back from the network to the upstream path. The upstream signal after EC becomes recovered and suitable to be received by the node receiver. Likewise, a CM also experiences various interferences in an FDX network; these need to be handled properly, even though the CMs operate in the FDD manner. Sources of interference generation come in different forms, such as reflections from different parts of the cable plant or lack of complete isolation between a pair of CMs or between a CM’s transmitter and receiver. Different kinds of interference can affect the FDX systems in different ways [5]. Co-channel interference (CCI) refers either to the interfering power added to the downstream path, or to the interfering power added to the upstream path

when simultaneous transmission and reception occur within the same sub-bands in an FDX network, despite the FDD operation in each CM group. Adjacent leakage interference (ALI) refers to the power that leaks from an upstream transmitting channel of a CM into the downstream receiving channel of the same CM in the FDX spectrum. Adjacent channel interference (ACI) refers to the power that remains in the same frequency band as the transmitted signal, but gets added into the receiver path through the coupling within the CM as well as reflections from the cable plant.

To avoid the risk of CCI, different approaches are specified and implemented in FDX systems. At a node, since the downstream signal power is much stronger than the received upstream signal, the CCI power resulting from the limited isolation of the internal coupler in the node and reflected downstream signal could be a lot stronger than the upstream signal power. It therefore needs to be cancelled by a powerful echo canceller. At a CM, CCI resulting from limited isolation between CMs is controlled by the CMTS. The CMTS schedules and grants transmissions in such a way that some CMs do not transmit at the same time as when other CMs, which are susceptible to their interference, are receiving. CM-to-CM interference susceptibility is measured through a sounding process [6], which is used to identify groups of CMs, called interference groups (IGs). To avoid the risk of ALI, the causes of the out-of-band spectrum of the upstream signal from the transmitter of a CM need to be identified and well controlled, e.g., the modulation nonlinearity, spurious noise, and some other ALI noise together with improved coupler isolation, etc. Because of significantly higher transmitted power relative to the received power at a CM, the power of ACI can be so high that it may saturate the CM receiver. Suppression and control of ACI may become necessary. To avoid the risk of ACI, an EC is desirable and suggested for the CM design. Some other means can also help mitigate ACI; an example would be improvement of the isolation between the transmitter and the receiver of a CM.

## 1.2. Summary

FDX is an advanced access network technology. It enables significantly higher upstream capacities while not sacrificing the downstream capacity based on the existing cable networks [7][8][9]. This is achieved by overlapping the upstream and downstream spectra and dynamically matching the customer demand in both the upstream and downstream directions by a unique RBA within FDX sub-bands, which offers multi-gigabit services. However, implementation of FDX requires a complicated and costly process of sounding, IG identification, EC, assignment of RBA, etc. Besides, the achievable network capacity for both downstream and upstream is a function of the network architecture, the performance of the network building blocks, and the strength of key technologies in FDX. It is thus helpful and desirable to study FDX systems and to predetermine the system performance and its capacity in the system design by providing an estimation of the interference levels and IGs, etc., before a physical FDX system is built. Some detailed theoretical analyses were carried out in previous work [4], where cable plant performance and the impact of different interferences on FDX networks were calculated and explained based on analysis of one span of a cable plant and the assumption of a network of equal tap spacing and tap S-parameter numbers. In this article, theoretical models for an FDX cable network are established based on a N+0 network structure, i.e., a node with no subsequent RF amplifiers in the cable plant, and the measured two-port S-parameters (S2P) or known RF performance of the network building blocks, such as nodes, taps, cables, and CMs. Our models mathematically formulate the interference coefficient of different types for an entire FDX network system and generalize the network types of any tap, cable, or cable lengths. Based on the S2P measurements, both amplitude and phase performance of the building blocks are introduced for more accurate calculation of coherent interferences summation. The accuracy of our models is verified by experimental results. For modelling purposes, we prove that performance of a tap with different pluggable components can be



computationally assembled. This makes it feasible to construct and model an FDX network and provides a quick and cost-effective way to estimate performance of FDX networks for the network design.

## 2. Theoretical Analysis

In this section, theoretical models are established for a node+0 network, which is currently the targeted FDX architecture. The models, which include various dominant interferences, are then used to calculate the coefficients of these interferences. The interferences in the cable plant can be sourced from any discontinuity or limited isolation. These include the limited isolation and reflections at nodes, reflections at taps and tap ports, the internal couplings of CMs, reflections at the CMs, non-ideal isolations between tap ports and tap output port, discontinuities along cables, etc. The analysis covers these sources of the interferences and calculates all interference types, i.e., CCI at a node and CCI, ALI and ACI at a CM.

### 2.1. CCI Due to Reflected Downstream Signal Back to the Node

The coefficient of the CCI interference at the node may be calculated as in equation (1). To help illustrate the CCI that happens at the node US receiver, a node+0 FDX network with various notations for the parameters used in Equation (1) is depicted in Figure 1.

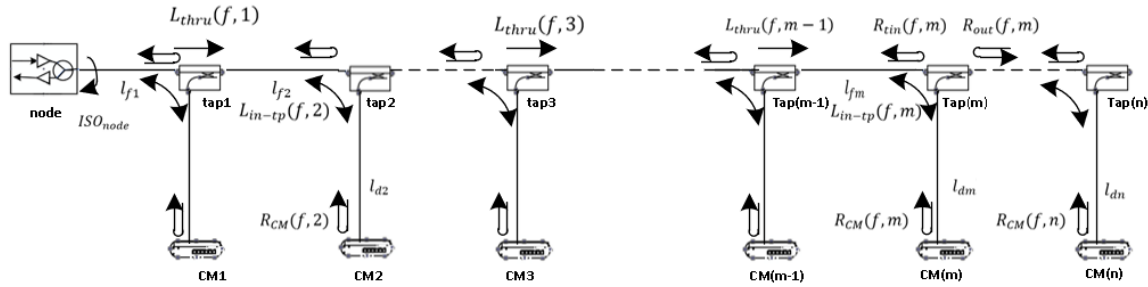


Figure 1 - A node+0 FDX network with notations of parameters used in Equation (1).

$$\begin{aligned}
 R_{node}(f) &= ISO_{node}(f) + R_{tin}(f, 0) + \sum_{m=1}^q R_{tin}(f, m) \prod_{n=1}^m L_{thru}^2(f, n-1) * \exp(-ik_f 2l_{fn}) L_f^2(f, n) \\
 &+ \sum_{m=1}^q L_{in-tp}^2(f, m) L_d^2(f, m) * \exp(-ik_d 2l_{dm}) * R_{CM}(f, m) \prod_{n=1}^m L_f^2(f, n) * \exp(-ik_f 2l_{fn}) \\
 &\approx ISO_{node}(f) + \sum_{m=1}^q R_{tin}(f, m) \prod_{n=1}^m L_{thru}^2(f, n-1) * \exp(-ik_f 2l_{fn}) L_f^2(f, n)
 \end{aligned} \tag{1}$$

where

$R_{node}(f)$  is the CCI coefficient of downstream signal back to the node receiver.

$ISO_{node}(f)$  is the isolation coefficient of the node output directional coupler;

$q$  is the total number of taps;

$R_{tin}(f, m)$  is the complex input reflection coefficient of the  $m_{th}$  tap;

$R_{tin}(f, 0)$  is the complex input reflection coefficient of the node output to the cable plant;

$L_{thru}(f, n - 1)$  is the complex primary through-path insertion loss coefficient of the  $(n-1)_{th}$  tap and  $L_{thru}(f, 0) = 1$ ;  
 $L_f(f, n)$  is the loss of the  $n_{th}$  feeder cable in the cable link;  
 $k_f$  is the transmission constant of the feeder cable;  
 $k_d$  is the transmission constant of the drop cable;  
 $l_{fn}$  is the length of the  $n_{th}$  feeder cable;  
 $l_{dm}$  is the length of the drop cable that is connected to the  $m_{th}$  tap;  
 $L_{in-tap}(f, m)$  is the complex coefficient of the insertion loss between the tap input and a tap port of the  $m_{th}$  tap;  
 $L_d(f, m)$  is the loss coefficient of the drop cable connected to a tap port of the  $m_{th}$  tap;  
 $R_{CM}(f, m)$  is the complex input reflection coefficient of a CM attached to the drop cable connected to the  $m_{th}$  tap;  
 $f$  is the RF frequency.

The above loss and reflection coefficients can be derived from the measured S2P parameters or datasheets of the modules of the building blocks in a cable plant. The cable's transmission constant can be calculated as

$$k_x = \frac{2\pi f}{C * v c_x} \quad (2)$$

where

$C$  is the light velocity in vacuum;  
 $v c_x$  is the velocity factor for the cable ( $x = f$  or  $d$  for feeder cable or drop cable, respectively).

It should be noted that:

- i.  $R_{tin}(f, m)$  is the reflection coefficient at the  $m_{th}$  tap input port.  $R_{tin}(f, m)$  accounts for multiple reflections between the  $m_{th}$  tap input port and the  $(m-1)_{th}$  tap output port and may be expressed as follows:

$$R_{tin}(f, m) = R_{in}(f, m) / (1 - \exp(-ik_f 2l_{fn}) L_f^2(f, n) R_{in}(f, m) R_{out}(f, m - 1)) \quad (3)$$

where

$R_{in}(f, m)$  is the complex reflection coefficient at the  $m_{th}$  tap input port;  
 $R_{out}(f, m - 1)$  is the complex reflection coefficient at the  $(m-1)_{th}$  tap output port;  
 $R_{in}(f, 0)$  is the complex reflection coefficient at the node output.

If  $R_{in}(f, m)$  and  $R_{out}(f, m - 1) \ll 1$ , then the above expression can be simplified to

$$R_{tin}(f, m) \approx R_{in}(f, m) \quad (4)$$

- ii. Complex reflection coefficients and insertion loss coefficients are derived from S2P measurements and used in the calculation in equation (1) and throughout this paper because these phases play an important part in the coherent summation of the interference terms.
- iii. Reflection in equation (1) from the CMs may be ignored as its strength is a lot lower than the reflection from the tap inputs because of the roundtrip loss through the tap ports and drop cables. Equation (1) therefore can be simplified.

As a use case and verification for the equation (1), cable plant input reflection coefficient—for the cable network as shown in Figure 2 is calculated. The types and lengths of cables and the taps used in this cable network are also given in Figure 2.

The plant power reflection coefficient in dB is calculated as

$$\Gamma_{plant}(f) = 20 * \log (|R_{node}(f)|) \tag{5}$$

The calculated and the measured results are shown in Figure 3. It is seen from Figure 3 that the calculated result matches the measured result reasonably well. The difference between the two curves might be caused by the fact that the S2P-parameters of the building block modules used in the calculation are measured with standard impedance while the S2P-parameters for the modules in the plant can be somewhat different. Coaxial cables' structural return loss could also be part of reason.

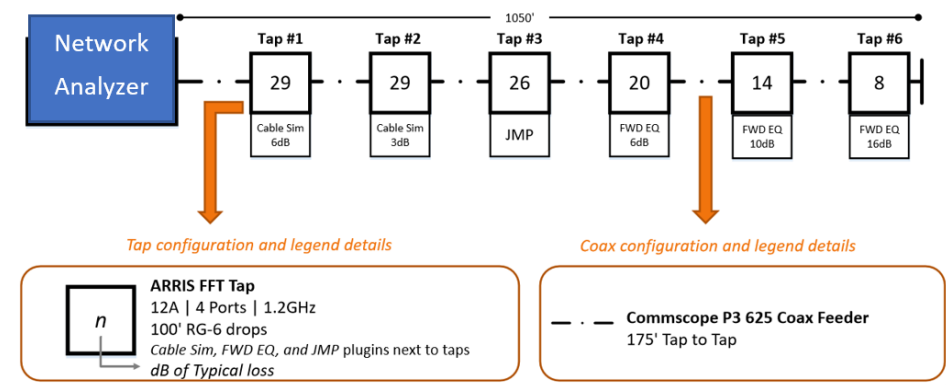
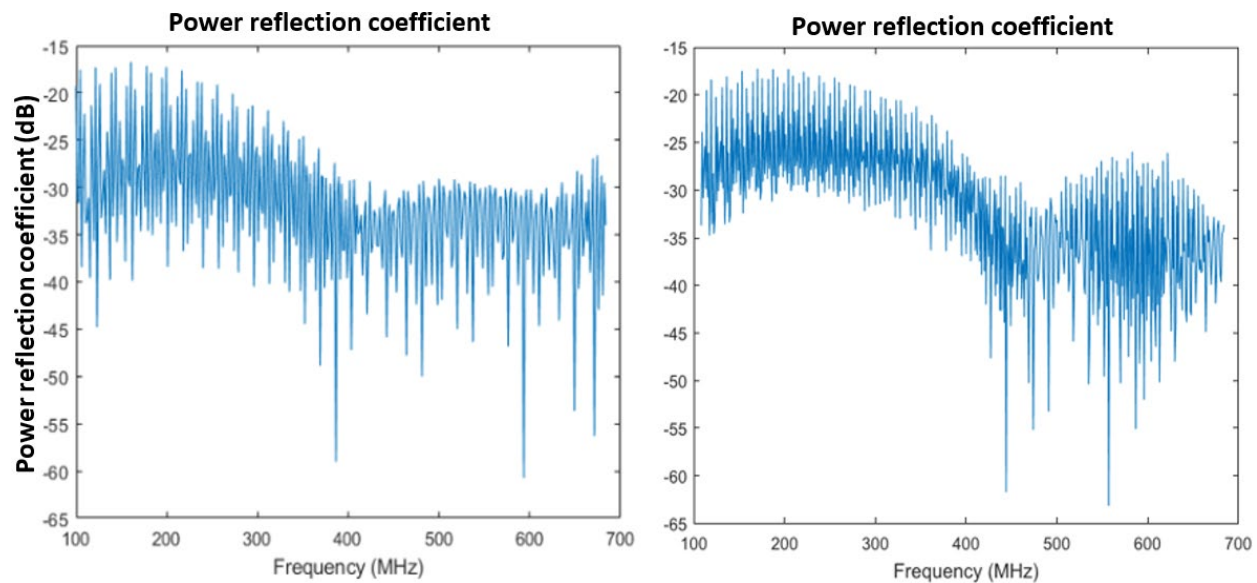


Figure 2 - An example of an FDX cable plant.



**Figure 3 - The power reflection coefficient of the cable plant in Figure 2. (a) the calculated result ; (b) the measured result.**

Note:

- i. The above calculation assumes that  $ISO_{node}(f) = 0$  due to the use of a network analyzer instead of a node. In addition, the connector return loss (RL) at network analyzer output port is assumed to be 35dB.
- ii. Our simulation showed that calculated results using amplitude-only reflection coefficients could be quite off from the measurement results, which is understandable in the case of coherent summation of interference items.

## 2.2. CCI Due to CM-to-CM Interference

The interference from a CM connected to one tap to a CM connected to another tap is defined as CM-to-CM interference. This is CCI that happens between CMs connected to different taps. The coefficient of the interference from a CM connected to the  $x_{th}$  tap to a CM connected to the  $y_{th}$  tap may be calculated as in equation (6). To help illustrate the CCI that happen at a CM receiver, a node+0 FDX network with various notations for the parameters used in equation (6) is depicted in Figure 4.

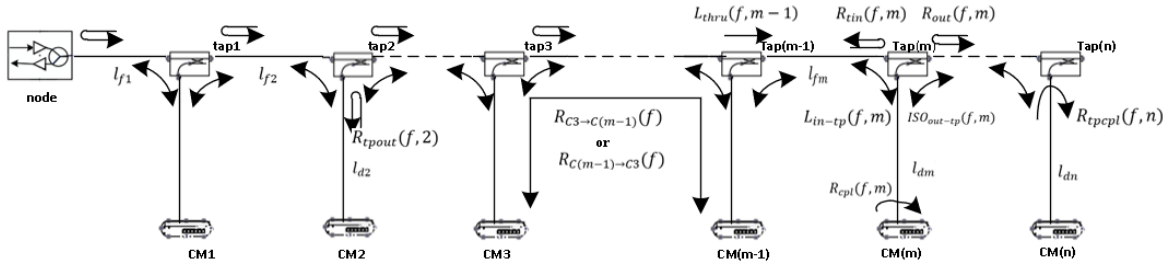


Figure 4 - A node+0 FDX network with notations of parameters used in Equation (6), (10), and (11).

$$\begin{aligned}
 R_{Cx \rightarrow Cy}(f) &= ISO_{out-tp}(f, x) \\
 &* L_d(f, x) \exp(-ik_f l_{dx}) L_d(f, y) \exp(-ik_f l_{dy}) \prod_{n=x+1}^y G(f, n) * L_f(f, n) * \exp(-ik_f l_{fn}) \\
 &+ \sum_{m=0}^{x-1} R_{tout}(f, m) L_{in-tp}(f, x) L_d(f, x) \exp(-ik_f l_{dx}) L_d(f, y) \exp(-ik_d l_{dy}) L_{thru}(f, x) \\
 &* \prod_{n=m}^{x-1} \{L_{thru}^2(f, n) \exp(-ik_f 2l_{f(n+1)}) L_f^2(f, n+1)\} \prod_{n=x+1}^y \{G(f, n) L_f(f, n) \exp(-ik_f l_{fn})\}
 \end{aligned} \tag{6.1}$$

when  $y > x$

$$\begin{aligned}
 R_{Cx \rightarrow Cy}(f) &= ISO_{out-tp}(f, y) \\
 &* L_d(f, x) \exp(-ik_f l_{dx}) L_d(f, y) \exp(-ik_f l_{dy}) \prod_{n=y+1}^x G(f, n) * L_f(f, n) * \exp(-ik_f l_{fn}) \\
 &+ \sum_{m=0}^{y-1} R_{tout}(f, m) L_{in-tp}(f, y) L_d(f, x) \exp(-ik_f l_{dx}) L_d(f, y) \exp(-ik_d l_{dy}) L_{thru}(f, y) \\
 &* \prod_{n=m}^{y-1} \{L_{thru}^2(f, n) \exp(-ik_f 2l_{f(n+1)}) L_f^2(f, n+1)\} \prod_{n=y+1}^x \{G(f, n) L_f(f, n) \exp(-ik_f l_{fn})\}
 \end{aligned} \tag{6.2}$$

when  $y < x$

where

$R_{Cx \rightarrow Cy}(f)$  is the complex coefficient of CCI from a CM of  $x_{th}$  tap to a CM of  $y_{th}$  tap;  
 $ISO_{out-tp}(f, u)$  ( $u=x$  or  $y$ ) is the complex isolation coefficient between a tap port of the  $u_{th}$  tap and its output (tap output), which is measured at a tap port when a signal is injected into the tap through output port in the reverse direction;  
 $R_{tout}(f, m)$  is the complex output reflection coefficient of the  $n_{th}$  tap port and  $R_{tout}(f, 0)$  represents the reflection coefficient at the cable network input or a node;

$$G(f, n) = \begin{cases} L_{thru}(f, n) & \text{when } n \neq y \text{ and } G(f, n) = L_{in-tp}(f, y) & \text{when } n = y \text{ in (6.1);} \\ L_{thru}(f, n) & \text{when } n \neq x \text{ and } G(f, n) = L_{in-tp}(f, x) & \text{when } n = x \text{ in (6.2).} \end{cases}$$

Again, as a use case and verification for the equation (6.x) (x=1 or 2), the tap-to-tap interference coefficient is calculated for the cable plant in Figure 2.

The tap-to-tap interference coefficient in dB can be expressed as

$$R_{Cx \rightarrow CydB}(f) = 20 * \log (|R_{Cx \rightarrow Cy}(f)|) \tag{7}$$

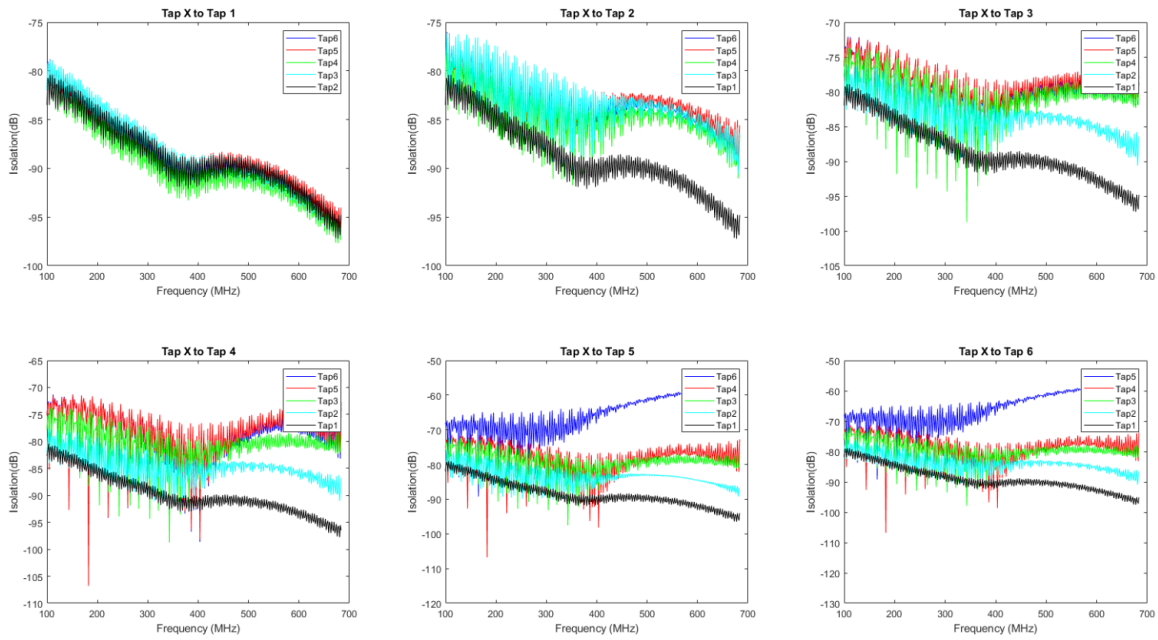
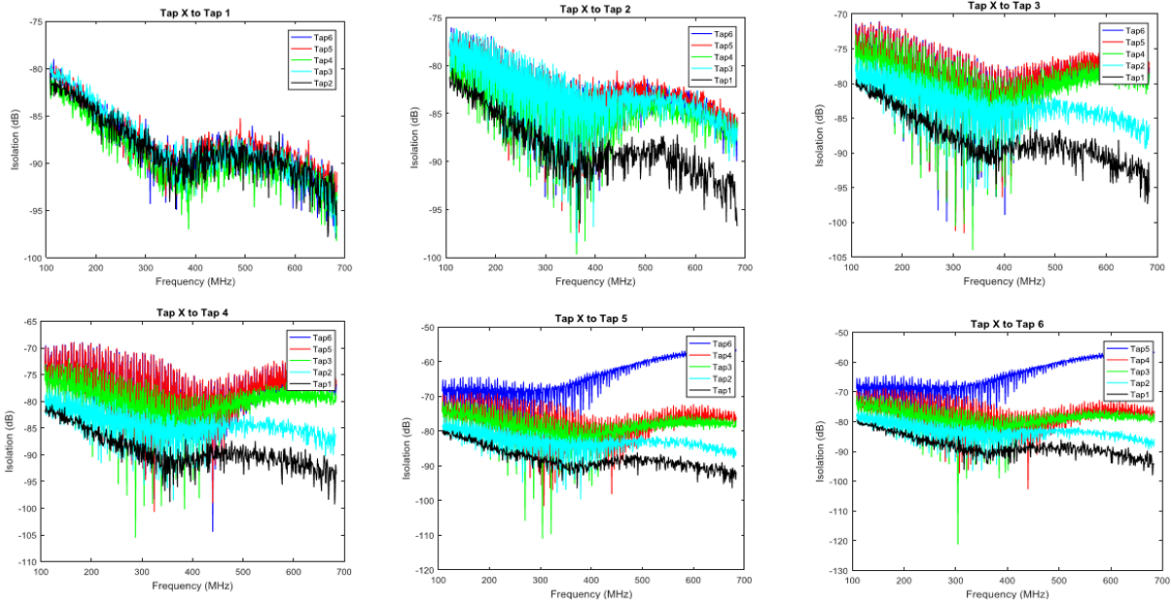


Figure 5 - CM-to-CM interference coefficient, calculated results.



**Figure 6 - CM-to-CM interference coefficient, measured results.**

The calculated results and measured results are shown in Figure 5 and Figure 6. The calculated results closely simulate the real system performance of tap-to-tap CCI interference. The small discrepancy between the calculated and measured results may again be caused by S2P-parameters difference of the modules measured with the standard load and measured in the real network. As in Figure 3, some ripples on the curves are seen because of coherent constructive and destructive summation of the interfering signals.

Note:

- i.  $R_{tout}(f, m)$  in Equation (6) is the reflection coefficient of the  $m_{th}$  tap output port, which accounts for multiple reflections between the  $m_{th}$  tap output port and the  $(m+1)_{th}$  tap input port.  $R_{tout}(f, m)$  may be expressed as follows:

$$R_{tout}(f, m) = R_{out}(f, m) / (1 - \exp(-ik_f 2l_{fn}) L_f^2(f, n) R_{in}(f, m+1) R_{out}(f, m)) \quad (8)$$

where

$R_{out}(f, m)$  is the complex reflection coefficient at the  $m_{th}$  tap output port;  
 $R_{in}(f, m+1)$  is the complex reflection coefficient at the  $(m+1)_{th}$  tap input port;  
 $R_{out}(f, 0)$  is the complex reflection coefficient at the node output.

If  $R_{out}(f, m)$  and  $R_{in}(f, m+1) \ll 1$ , then the above expression can be simplified to

$$R_{tout}(f, m) \approx R_{out}(f, m) \quad (9)$$

- ii. In the calculation, it is assumed that the RL at the input of the cable plant is 30dB when it is terminated with an RF terminator of good quality.
- iii. Again, our simulation showed that calculated results using amplitude-only reflection and insertion loss coefficients could be quite off from the measurement results.

### 2.3. Interference Between CMs Connected to the Same Tap

This type of interference can be divided into CM self-interference and CM mutual interference. Self-interference is defined as the interference generated by a CM to itself, while mutual interference is defined as the interference generated from one CM to another CM connected to the same tap. The self-interference coefficient of a CM, which is connected to the  $n_{th}$  tap, may be calculated as follows:

$$\begin{aligned}
 R_{CMself}(f, n) &= R_{cpl}(f, n) + R_{tpout}(f, n)L_d^2(f, n) \exp(-ik_d 2l_{dn}) \\
 &\quad + L_{in-tp}^2(f, n)L_d^2(f, n) \exp(-ik_d 2l_{dn}) \\
 &\quad * \sum_{m=0}^{n-1} R_{tout}(f, m) \prod_{j=m}^{n-1} L_{thru}^2(f, j) * \exp(-ik_f 2l_{f(j+1)}) * L_f^2(f, j + 1) \\
 &\approx R_{cpl}(f, n) + R_{tpout}(f, n)L_d^2(f, n) \exp(-ik_d 2l_{dn})
 \end{aligned} \tag{10}$$

where

- $R_{CMself}(f, n)$ , is the complex self-interference coefficient of a CM connected to the  $n_{th}$  tap;
- $R_{cpl}(f, n)$  is the complex coefficient of coupling between the transmitter and receiver in a CM connected to the  $n_{th}$  tap;
- $R_{tpout}(f, n)$  is the complex reflection coefficient at a tap port of the  $n_{th}$  tap.

The coefficient of mutual interference between CM1 and CM2, which are all connected to the same  $n_{th}$  tap, may be calculated as follows:

$$\begin{aligned}
 R_{CMmut}(f, n) &= R_{tpcpl}(f, n)L_d(f, n_1)L_d(f, n_2) * \exp(-ik_d(l_{dn1} + l_{dn2})) \\
 &\quad + L_{in-tp}^2(f, n)L_d(f, n_1)L_d(f, n_2) \exp(-ik_d(l_{dn1} + l_{dn2})) \\
 &\quad * \sum_{m=0}^{n-1} R_{tout}(f, m) \prod_{j=m}^{n-1} L_{thru}^2(f, j) * \exp(-ik_f 2l_{f(j+1)}) * L_f^2(f, j + 1) \\
 &\approx R_{tpcpl}(f, n)L_d(f, n_1)L_d(f, n_2) * \exp(-ik_d(l_{dn1} + l_{dn2}))
 \end{aligned} \tag{11}$$

where

- $R_{CMmut}(f, n)$  is the complex mutual interference coefficient;
- $R_{tpcpl}(f, n)$  is the complex mutual coupling coefficient between two tap ports of the  $n_{th}$  tap;
- $l_{dn1}$  and  $l_{dn2}$  are the lengths of the drop cables of the same type that connect CM1 and CM2 to their respective tap port of the  $n_{th}$  tap.

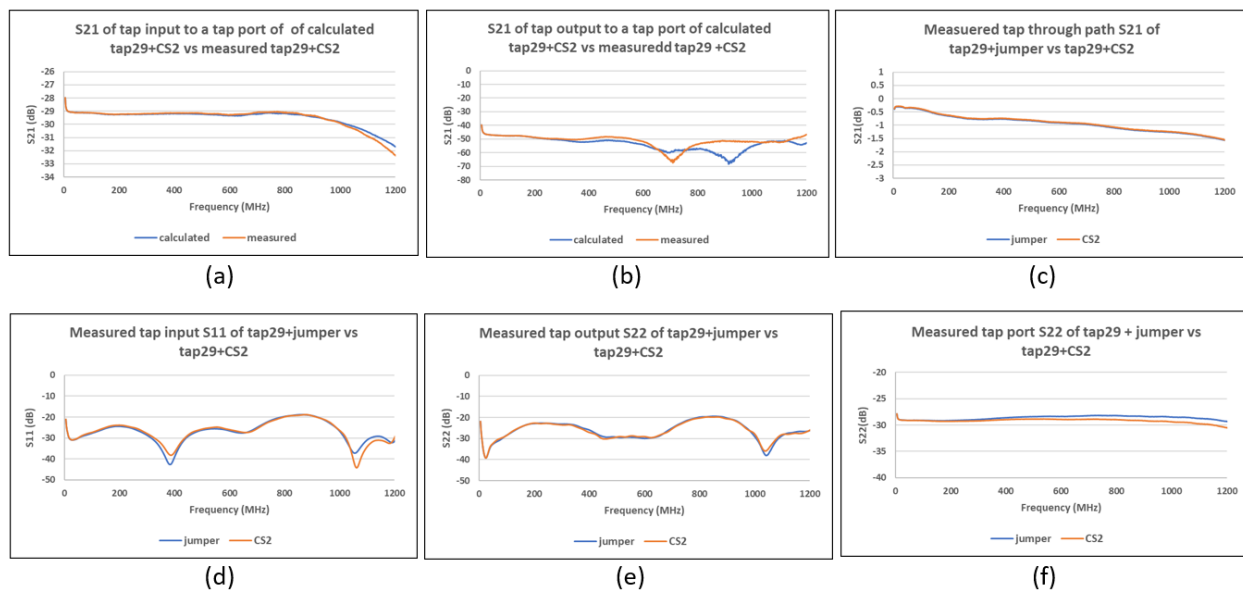
## 3. Building Blocks for Cable Network Modelling

The theoretical analyses given in the previous section are based on the RF characteristics of the network building blocks and are proven to be effective means of predicting performance of FDX cable networks with node+0 architecture. It is therefore cost-effective and convenient to build simulation models for the performance analysis and estimation for FDX networks before the real cable systems are built. To build these network models, some basic RF characteristics of the network building blocks are needed, such the

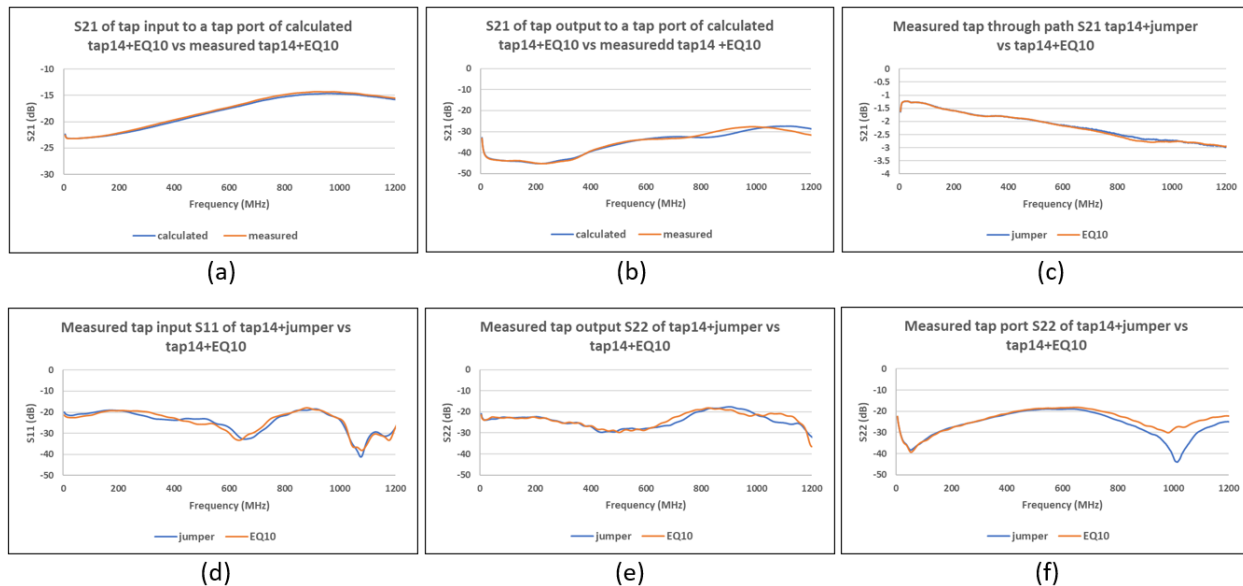


S2P-parameters of the taps, connectors, nodes, CMs, and cables. Many of these typical parameters are known or available in the respective product datasheets. However, in real network designs, some building block components, e.g., taps, need to be assembled based on the network structure. Taps are assembled with a base tap (face plate) and some pluggable such as cable simulators (CS), jumpers, and equalizers (EQ). The RF performance of assembled taps will depend on the performance of the base tap and the pluggable component. For simulation flexibility, it is desirable and convenient if the physical RF characteristics of the assembled taps can also be computationally “assembled” or replicated from the known S2P-parameters of each individual components so that the entire network can be built in the simulator as done in a real physical network. In this section, RF performance of some computationally assembled taps is evaluated and compared with their corresponding real taps.

For taps, the S2P-parameters of base taps and pluggable components are physically characterized individually. Thus, for simulation purpose, RF performance of an assembled tap is computed from the RF performance of a base tap and its pluggable component. We will show that the calculated results can replicate real assembled tap performance in the simulation environment through several examples of tap assemblies. We first choose the 2<sup>nd</sup> tap with a CS and the 5<sup>th</sup> tap with an EQ in Figure 3 as examples. The calculated and measured amplitudes are shown in Figure 7 and Figure 8



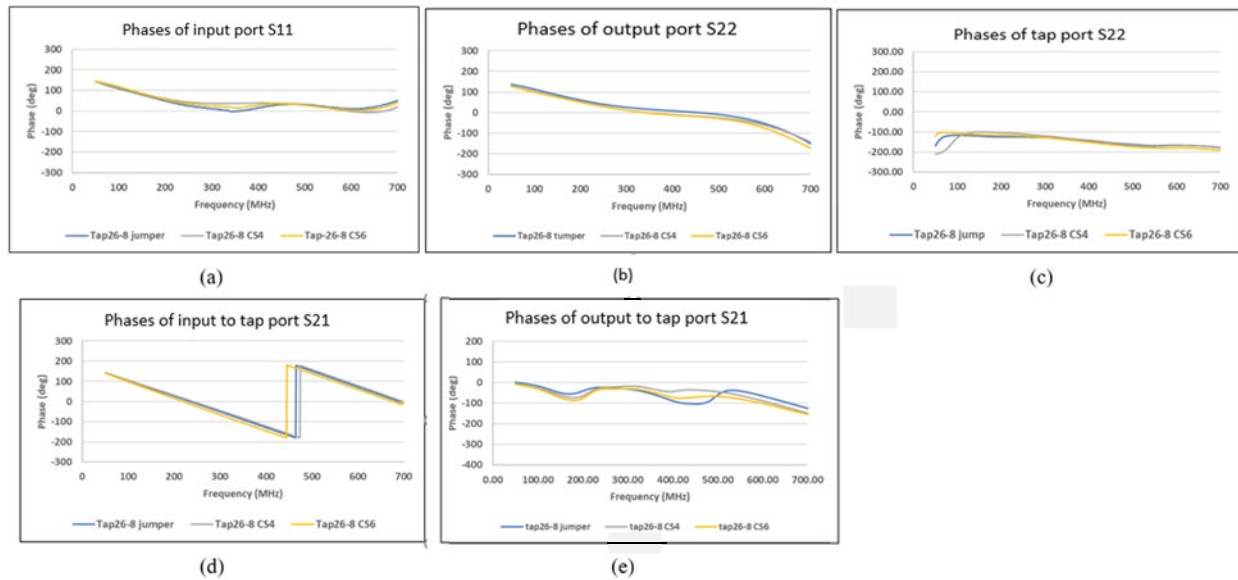
**Figure 7 - Comparison of calculated and measured S2P-parameters ((a)-(b)) of the assembled 2nd tap and measured S2P-parameters with and without the CS ((c)-(f)) of the 2nd tap: (a) tap input to a tap port  $S_{21}$ ; (b) tap output to a tap port  $S_{21}$ ; (c) tap through-path  $S_{21}$ ; (d) tap input  $S_{11}$ ; (e) tap output  $S_{22}$ ; (f) tap port  $S_{22}$ .**



**Figure 8 - Comparison of calculated and measured S2P-parameters ((a)-(b)) of the assembled 5th tap and measured S2P-parameters with and without the EQ ((c)-(f)) of the 5th tap: (a) tap input to a tap port  $S_{21}$ ; (b) tap output to a tap port  $S_{21}$ ; (c) tap through-path  $S_{21}$ ; (d) tap input  $S_{11}$ ; (e) tap output  $S_{22}$ ; (f) tap port  $S_{22}$ .**

In the above examples, the assembled insertion loss between the tap input and a tap port is calculated by adding the insertion loss of the base tap input and the tap port, which is measured with a jumper, and the insertion loss of the pluggable device. The through path insertion loss of the tap is only determined by the through path insertion loss of the directional coupler in the tap. The assembled tap output to a tap port insertion loss or isolation is calculated by adding the base tap port isolation, which is measured with a jumper, and the insertion loss of the pluggable device. It is seen that for assembled taps (tap+pluggable), the input and output return loss are not affected by the pluggable devices nor is the tap port return loss significantly affected by the pluggable devices due to isolation of the internal structure of the tap device, e.g., tap ratio and splitters

Since the phase information is also important for an accurate simulation, it is necessary to examine phases of a tap when it is assembled with different pluggable components. Figure 9 shows the measured phases of three CommScope FTT26-8 taps of different pluggable components. It is seen from Figure 9 that phases of all taps are not significantly affected by the type of pluggable components. These results are not surprising because the phases of insertion losses and reflections are primarily determined by the physical dimensions of the base tap, pluggable components and isolation of the basic components in the tap, such as the couplers and splitters. Pluggable components are relatively small compared to the base tap in their physical dimensions and comparable in their form factors. Thus, the phase of a tap characterized with its base tap can be used in the simulation regardless of the type of its pluggable components.



**Figure 9 - Comparison of S2P-parameters of FTT26-8 with different pluggable components: (a) measured phases of input  $S_{11}$ ; (b) measured phases of tap output  $S_{22}$ ; (c) measured phases of a tap port  $S_{22}$ ; (d) measured phases of tap through  $S_{21}$ ; (e) measured phase of tap output to a tap port  $S_{21}$ .**

It is thus proven that the RF performance of the assembled devices can be mathematically assembled within the FDX spectrum, which is expected intuitively. For modelling purposes, a library of components with their RF characteristics, such as cables, taps, pluggable components, connectors, nodes, CMs, etc., needs to be made available. With the library, network modelling can be readily constructed piece by piece in software, as in Matlab’s Simulink, for example, so that an FDX network’s performance can be simulated and estimated.

#### 4. Application

In Section 2, the theoretical basis for analyzing various interferences is established. The actual interference impact on the signal-to-noise ratio of the affected sub-band can be readily calculated once the power density function from the node transmitter and the cable modem transmitters is known. In this section, an example is given to demonstrate the application of our analyses for the system performance prediction.

In DOCSIS 3.1 the maximum total composite power (TCP) of a CM was increased to 65 dBmV from 57 dBmV in DOCSIS 3.0 to take care of the increase of the upstream signal bandwidth from 5 MHz to 42MHz, to 5 MHz to 204 MHz so that the power density of the upstream signal at the node receiver can still be maintained. However, for FDX applications, TCP of the FDX CMs is still specified as 65 dBmV which may make the node receiver power lower. This receiver power gap might be taken care of by the coding gain of the new error correction code which is adopted in DOCSIS 3.1 OFDM modulation. In FDX systems, this power of 65 dBmV is assumed to be distributed with up-tilted power density (PD) across the bandwidth between 5 MHz and 684 MHz. This power density distribution is simulated in the following analysis.

Prediction of the cable network performance is also based on the following assumptions:

$RL_{node} = 16 \text{ dB}$  for node output RL;  
 $ISO_{node} = 20 \text{ dB}$  for node isolation between TX and RX;  
 CM receiver power for DS signal = 0 dBmV/6 MHz;

Note: All the above parameters could be functions of frequency but are assumed to be constants for simplicity.

In the following simulation, the cable network in Figure 2 is calculated. The spectrum analyzer there in the cable network is now replaced by a node. Based on the network in Figure 2 and the above assumptions, the node transmitter output power is calculated to be about 65 dBmV which is distributed over a 50 MHz to 1.2 GHz bandwidth with 16 dB up-tilt.

The interference to the node receiver is the reflected downstream signal. It needs to be cancelled by the node ECs in the FDX application as discussed earlier. The system performance at the node receiver is calculated and gauged by signal-to-noise ratio (SNR) where signal is represented by the upstream signal power density and the noise is represented by the echoed downstream signal power density without EC. In the previous CCI analysis, the reflection by the connector at the interface between the network analyzer and cable network is small and is now replaced by the RL at the node and cable input. Besides, the non-ideal isolation of the coupler between the node transmitter and receiver, which is worsened by the non-ideal node return loss, is an additional contribution to the interfering signal. This isolation contribution is taken into account by  $ISO(f)_{node}$  in equation (1)

The interfering signal power density without EC at the node can be expressed as

$$PD_{nodeinf}(f) = P_{DS}(f) * |R_{node}(f)|^2 \quad (12)$$

where

$PD_{nodeinf}(f)$  is the interference power density caused by the reflected DS signal;  
 $PD_{DS}(f)$  is the power density of the DS signal transmitted from the node;  
 $R_{node}(f)$  is given by equation (1).

The power density of the upstream signal at the node receiver is calculated as

$$PD_{USRX}(f, n) = PD_{CM}(f) * |IL_n(f)|^2 \quad (13)$$

where

$PD_{USRX}(f, n)$  is the upstream signal power density at the node receiver;  
 $PD_{CM}(f)$  is the CM output power density for TCP of 65 dBmV distributed between 5 MHz~684 MHz with a tilt of 11 dB;  
 $IL_n(f)$  is the transmission coefficient between a CM of the  $n_{th}$  tap and the node.

The calculated SNRs from different taps are shown in Figure 10. Apparently, the US signals will become useful only if the interfering signals are cancelled. The amount of cancellation needs to be about 50 dB to achieve about 35 dB SNR for 1024-QAM OFDM transmission or more cancellation for QAM of higher order.

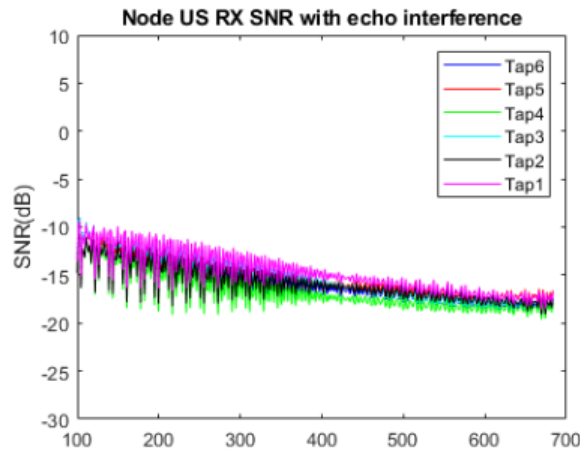


Figure 10 - SNR at the node receiver for US signals from different taps.

## 5. Conclusion

With the analyses in Section 2, all forms of interference of an FDX system are described mathematically. Our models generalize analyses for an entire node+0 FDX network of any type. Our analyses and models are validated by our experimental results. The modelling can also incorporate some other degradation factors conveniently, such as the reflections caused by discontinuities along a coaxial cable due to some cable defects. On the other hand, the RF performance characteristics of the computational tap assemblies are examined and the assemblies are thus proved to be feasible for simulation purposes, that allow flexibly building a network as designed. An example of system performance prediction was also demonstrated using our analysis. Therefore, as a cost-effective and quick means, our models can be used to design, build and analyze an FDX network using a library of building blocks, and to evaluate the performance of FDX systems before the systems are physically built.

The models can also be used to identify some dominant factors that affect the system performance by changing the values of certain factors in the network or by turning them on and off. Meanwhile some system parameters, such as TCP and tilt of PD of the transmitters of both node and CMs can be adjusted and balanced so that the overall system performance can be optimized for the best network throughput in both downstream and upstream transmission. They can thus help provide a guideline for the improvement of the building blocks and the product specification of the building blocks and understand the effectiveness of the network optimization for the network design.

## 6. Acknowledgement

The authors would like to thank Don Wilson, Matt Calderone, Steve Frederic, Stuart Eastman and Zoran Maricevic for many helps.

## 7. Abbreviations

ACI	adjacent channel interference
ALI	adjacent leakage interference
CAA	centralized access architecture
CCI	co-channel interference

CM	cable modem
CMTS	cable modem termination system
CS	cable simulators
DAA	distributed access architecture
dB	decibel
dBmV	decibels relative to one millivolt
DS	downstream
EQ	equalizers
FDD	frequency division duplex
FDX	full duplex
HFC	hybrid fiber/coax
IGs	interference groups
IoT	Internet of Things
MHz	Mega hertz
OFDM	orthogonal frequency division multiplexing
PD	power density
QAM	quadrature amplitude modulation
RBA	resource block assignment
RL	return loss
R-PHY	remote PHY
S2P	two-port S-parameters
SCTE	Society of Cable Telecommunications Engineers
SNR	signal-to-noise ratio
TCP	total composite power
US	upstream

## 8. References

1. Data-Over-Cable Service Interface Specifications DOCSIS® 3.1
2. Physical Layer Specification, Data-Over-Cable Service Interface Specifications DOCSIS® 4.0.
3. Karthik Sundaresan, “FDX & D3.1 Capacity Scenarios- Understanding overheads and RBA configurations,” 2018 Fall Technical Forum, SCTE.ISBE NCTA.CABLELABS.
4. Richard S. Prodan, “Full Duplex DOCSIS PHY Layer Design and Analysis for the Fiber Deep Architecture”, 2017 Fall Technical Forum, SCTE.ISBE NCTA.CABLELABS.
5. Hang Jin, John Chapman, “Echo Cancellation Techniques for Supporting Full Duplex DOCSIS”, 2017 Fall Technical Forum, SCTE.ISBE NCTA.CABLELABS.
6. John Chapman, Hang Jin, “Full Duplex DOCSIS”, 2016 Fall Technical Forum, SCTE.ISBE NCTA.CABLELABS.
7. Frank O’Keeffe, Ayham Al-Banna, Tom Cloonan, “Full duplex DOCSIS & extended spectrum DOCSIS hold hands to form the 10G cable network of the future,” IBC 2019.
8. Ayham Al-Banna, Frank O’Keeffe, Tom Cloonan, “Operational Considerations & Configurations for FDX & Soft-FDX- A Network Migration Guide To Converge The Cable Industry,” 2019 Fall Technical Forum, SCTE.ISBE NCTA.CABLELABS.
9. Robert Howald, Sebnem Ozer, Robert Thompson, Saif Rahman, Richard Prodan and Jorge Salinger “What is 10G – The Technology Foundation” 2017 Fall Technical Forum, SCTE.ISBE NCTA.CABLELABS.

# Access Network Powering

## Network Power Considerations for 10G Enhancements

A Technical Paper prepared for SCTE by

Rob Anderson,  
Director of Product Management, EnerSys  
SCTE Member  
3767 Alpha Way  
Bellingham, WA 98226  
randerson@alpha.com  
360-392-2293

## Table of Contents

Title	Page Number
Table of Contents	24
1. Introduction	25
2. Access Network Powering Review	25
2.1. HFC Power Supplies	26
2.2. Network Powering Example	27
3. Distributed Access Architecture and Remote PHY	29
3.1. DAA Overview	29
3.2. Intra-Node Power Hold-Up Time	31
3.3. Utility Grid Backup Requirements	31
4. Powering 5G Small Cells from the Access Network	32
4.1. Access Network RAN Powering	32
4.2. Adding Small Cells Radios	33
5. Conclusions	35
6. Abbreviations	36
7. Bibliography and References	37

## List of Figures

Title	Page Number
Figure 1 - Sample HFC Access Network	25
Figure 2 - Pole Mounted Broadband Power Supply	26
Figure 3 - Network Segment Powering Example	27
Figure 4 - DAA Configuration	30
Figure 5 - Access Network Powering Example	32
Figure 6 - Access Network Small Cell Powering Example	34

## List of Tables

Title	Page Number
Table 1 - Cable Spans for HFC Powering Example	28
Table 2 - HFC Powering Example Results	29
Table 3 - Cable Span Lengths	33
Table 4 - HFC Powering Before Small Cells	33
Table 5 - HFC Powering with Small Cells	35



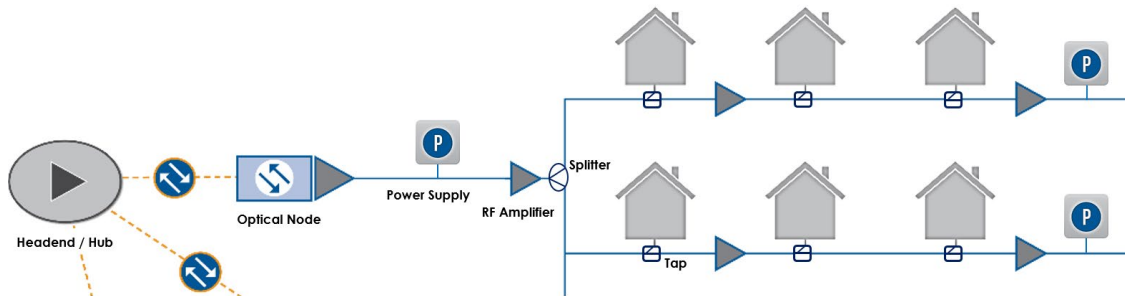
## 1. Introduction

Assuring the availability of additional, reliable, and intelligent power for the near future 10G-capable access network is both essential and challenging since network architectures are evolving and 10G enabling technologies are still being developed [1]. In this paper we review two specific access network upgrades through the lens of network power. First, distributed access architecture (DAA) optical nodes (ONs) bring higher bandwidth closer to consumers. Remote PHY (R-PHY) nodes are one example of a DAA implementation [2]. R-PHY nodes bring new powering challenges to the access network including the need for high quality, resilient power. Second, recent operator investments in CBRS RF spectrum are good indicators that access network powered small cell radio area networks (RANs) will soon be scaling up. New radio installations come with new power level and voltage reach challenges for the access network.

This paper reviews access network powering concepts and challenges as R-PHY nodes and small cell radios are incorporated into the network. We begin with a review of access network powering concepts.

## 2. Access Network Powering Review

The access network includes all network elements beyond the headend/hub and up to the premises. Some network architectures utilize virtual hubs housed within outdoor sealed enclosures; these are also considered part of the access network. A simplified access network block diagram is shown in Figure 1.



**Figure 1 - Sample HFC Access Network**

In the traditional hybrid fiber/coax (HFC) access network, signals from the headend/hub are transmitted over fiber optic cable to optical nodes. Nodes convert between optical and electrical (RF) signals and convey those signals to multiple coax network segments. Each coax segment typically consists of a tree-and-branch structure for signal distribution. Passive splitters subdivide the signal into multiple paths (branches). Amplifiers are located throughout the coax network segment to boost signals, providing appropriate signal levels to the end users, which are typically homes and businesses. Directional taps located near the end users “tap off” some of the signal from the main coaxial cable into drop cables that bring the signals into the customer premises. Nodes and amplifiers require power. Power is also consumed by coax line loss from joule heating ( $I^2R$  losses). Power and RF signals are both multiplexed into the coax, eliminating the need for separate power and signal cables. Uninterruptable power supplies (UPS) are placed as needed throughout the access network to provide power to nodes and amplifiers.

## 2.1. HFC Power Supplies

Power for HFC components is provided by a specialized backup power system known as a broadband UPS.<sup>1</sup> UPS systems are physically located throughout the coax portion of the network where required to provide power for each active network element. UPSs are physically installed on outdoor utility poles, in dedicated ground mounted enclosures, and in secured utility areas of multiple dwelling units (MDUs). A typical utility pole mounted broadband UPS is shown in Figure 2.



**Figure 2 - Pole Mounted Broadband Power Supply**

The UPS converts utility power (120 VAC or 240 VAC in North America) to 90 VAC for insertion into the coax. Early cable networks used 30 VAC then later 60 VAC for network power. Today, networks almost exclusively use 90 VAC power with a few older 60 VAC networks still in operation.

Unlike utility service which provides sinusoidal AC power, the broadband UPS produces a quasi-square wave or trapezoidal-shaped power output. This wave shape is a result of the ferroresonant transformer used in broadband UPS systems. The ferroresonant transformer provides a high level of electrical isolation, protecting the access network components from utility line power surges and transients that could damage sensitive electronics. The ferroresonant transformer also regulates the broadband UPS's output voltage, compensating for input voltage variations.

Batteries within the UPS system enable the power supply to provide continuous, reliable backup power to the access network during utility disruptions. The output of the UPS is connected to a power inserter, which acts like a reverse directional tap, to inject power into the coax cable. Some operators use the term “shunt” to describe the process of injecting power or shunting power into the coax.

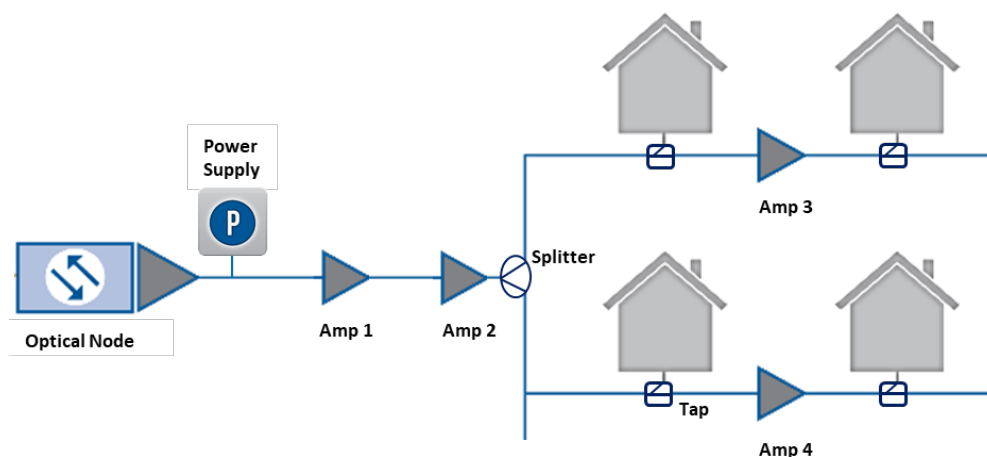
<sup>1</sup> In the past these were commonly called standby power supplies.

Within the access network each amplifier and line passive device can be configured to pass power through itself and on to the next device in the network or to block power from passing through itself. The decision to pass or block power within a specific network device is determined by the operator and is based on criteria including:

- Do downstream devices require power and if so, how much?
- Does the UPS system have sufficient capacity to power future planned devices?
- Will powering additional devices cause the UPS system to exceed the cable broadband operator’s maximum powering policy?

## 2.2. Network Powering Example

Figure 3 shows a simplified HFC network segment to illustrate some basic powering concepts. In practice, HFC powering is more complex than illustrated but several basic principles are shown.



**Figure 3 - Network Segment Powering Example**

In this example a broadband UPS is connected to the coax that is fed by a nearby optical node. The node is powered from this coax segment. Amplifiers (“Amp”) 1-4 are also powered from this UPS. Amp 1 and Amp 2 are each configured to pass power through their chassis, enabling downstream devices to be powered from the UPS. The splitter is configured to pass power through both outputs. Amp 3 and Amp 4 are powered from the UPS and are configured to block power from passing to their respective outputs eliminating additional power draw from any components further down the coax.

Assume that the optical node requires 80 watts (W) of power and amplifiers 1-4 each require 70 W of power to operate. Also assume the UPS output is configured to 90 VAC and that it is rated to provide up to 1350 W of power. For simplicity, ignore coax line loss for now. The total power required is calculated as the sum of power required from each network active:

$$P(\text{Actives}) = P(\text{Node}) + P(\text{Amp1}) + P(\text{Amp2}) + P(\text{Amp3}) + P(\text{Amp4})$$

$$\text{Total Power (Actives)} = 80 \text{ W} + (70 \text{ W} \times 4) = 360 \text{ W}$$

To make our example more realistic we include coax line loss in our power equation. Assume all coax is 0.625 inches diameter which has a typical loop resistance of 0.0011 ohm/foot (1.1 ohms per 1000 feet). Also, assume the following coax span lengths.

**Table 1 - Cable Spans for HFC Powering Example**

From	To	Span (ft)
UPS	node	~0
node	amp 1	1,000
amp 1	amp 2	1,000
amp 2	splitter	1,000
splitter	amp 3	1,000
splitter	amp 4	1,000

Note: Using these assumptions, the total coax length between the UPS and amplifier 3 or the UPS and amplifier 4 is 4000 ft.

Let's calculate the power lost in a single 1,000 ft segment of coax. Using Ohm's Law:

$$P(\text{loss}) = I^2R$$

where:

$P(\text{loss})$  = power lost from coax line resistance, measured in watts. Note: this energy is converted to heat, hence the term joule heating for  $I^2R$  losses.

$I$  = current through the cable, measured in amps

$R$  = loop resistance of the length of cable, measured in ohms

Taking amplifier 1 in isolation, we calculate the power lost in the coax segment between the UPS and amplifier 1 as follows:

$$P(\text{loss}) = (70 \text{ W}/90 \text{ V})^2 \times (0.0011 \text{ ohm/ft} \times 1,000 \text{ ft}) = 0.67 \text{ W}$$

In this example we used the Ohm's Law relationship:  $I = P/V$  for the first term.

$I=P/V$  is an ideal approximation. In real-world calculations we must account for cumulative voltage drops across each coax segment, i.e., the 90 VAC at the UPS output is reduced through each coax segment. The voltage drop is proportional to both cable resistance and current per the relationship:

$$V(\text{drop}) = I(\text{cable}) \times R(\text{cable})$$

HFC active elements, including nodes and amplifiers, are typically constant power devices. As input voltage to a device is reduced due to coax line resistance, the device's current consumption will increase to maintain the required power load ( $P=VI$ ). As the current increases, power loss through the coax increases. Recall this relationship discussed earlier:  $P(\text{loss}) = I^2R$ .

In this example the node and four amplifiers require 360 W to operate. Additional energy consumed (lost) due to voltage drops across the various coax segments can be calculated to be an additional 35.5 W. Detailed calculations have been omitted for brevity. Results are summarized in Table 2.

**Table 2 - HFC Powering Example Results**

<b>Configuration</b>	<b>PS I(out)</b>	<b>EOL Voltage</b>	<b>Actives Load</b>	<b>I<sup>2</sup>R Loss</b>	<b>PS Utilization</b>
Analog node, 4x Amplifiers	4.4 A	79.4 V	360 W	35.5 W	29%

With the UPS capacity of 1350 W, the total power used (active loads + I<sup>2</sup>R loss) has consumed 29% of the available power.

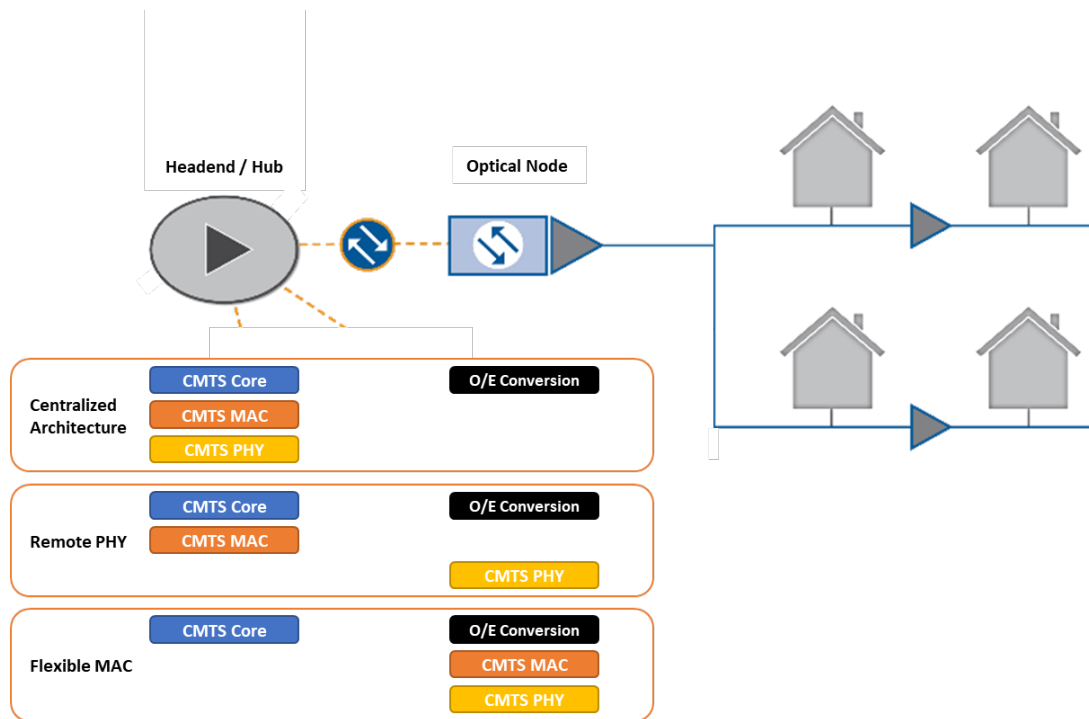
End of line (EOL) voltage is another important parameter to monitor. EOL voltage is the input voltage of the last active device in the network. Typically, EOL voltage must be above 45 V for most HFC equipment to operate. For this example, we’re well within acceptable operating parameters for both UPS power and EOL voltage. As new equipment and services are added to the access network power must be reviewed through each step of the process.

### 3. Distributed Access Architecture and Remote PHY

#### 3.1. DAA Overview

Distributed access architectures relocate or distribute functions that traditionally reside in the headend or hub to locations closer to the user. Moving functions deeper into the network reduces power and space demands in the headend/hub. As functions move closer to users the network experiences improvements in efficiencies, speed, reliability, latency and security [2].

R-PHY and flexible MAC architecture (FMA) are implementations under the DAA umbrella. Both technologies move processing functions from the headend/hub to distributed optical nodes as shown in Figure 4.



**Figure 4 - DAA Configuration**

Operators transitioning from traditional analog optical nodes to DAA nodes must increase their node power budget. A typical analog node consumes about 80 W of power to operate. An equivalently configured DAA node requires more power. Current industry data indicates that DAA node power consumption is in the range of 140 W to 190 W with FMA capable nodes requiring more power than R-PHY capable nodes. As field programmable gate arrays (FPGA) and application specific integrated circuits (ASIC) evolve, this power consumption is expected to improve.

At the time of this paper’s publication DOCSIS® 4.0 has not yet been implemented in DAA nodes. DOCSIS 4.0 radio frequency (RF) signaling, including full duplex (FDX) DOCSIS and extended frequency division duplex (FDD) DOCSIS with downstream spectrum support to 1,794 MHz, are generated in the PHY component of the DAA node [3]. Specific power requirements for DOCSIS 4.0 enabled DAA nodes are currently available.

Beyond current DOCSIS 4.0 standards, there are industry proposals to extend the downstream spectrum to 3 GHz and potentially higher. This next-generation RF band upgrade could enable upstream speeds in excess of 9 Gbps and downstream speeds to 25 Gbps. This concept utilizes small RF amplifiers near the premises, providing signal amplification for the 1.2 GHz to 3 GHz range [4]. The impact of this enhanced RF spectrum on access network power would be speculative at this stage so we will leave powering this concept for a future discussion.

### 3.2. Intra-Node Power Hold-Up Time

Recently, a North American operator experienced service affecting power related problems with several R-PHY nodes. The nodes would reset and would then require several minutes to power-up and provision. The result was loss of service for several hundred customers within the service areas of the affected nodes. After extensive investigation by the operator and by multiple vendors the root cause for the resetting nodes was determined to be power related. Technicians working downline from the node were servicing network components and had inadvertently shorted the coax center conductors to ground causing a brief power disruption. In each case, the power anomaly was sufficient enough to cause the node to reset, dropping customer service for several minutes.

This example illustrates the critical nature of reliable power. Power reliability is especially vital with digital nodes where power disruptions can cause CPUs to reset. The node must reboot and then re-establish communications links independently to both the headend and to each user. The cycle of reboot and re-provisioning has been observed to take up to 15 minutes with some R-PHY nodes. Many power related service disruptions can be mitigated with planning and preparation. A few ideas are discussed here.

In the prior node reset example the cause of the power disruption was a momentary short in the coaxial cable carrying power to the node. A UPS system that is operating perfectly could not mitigate this type of power disruption. To the UPS system, a coax line short would appear as a current spike on its output. If the short occurred close enough to the UPS, its ferroresonant transformer would fold-back, dropping output voltage until the fault was cleared. If the line short was some distance from the UPS, the coax line resistance would mitigate the short and it would appear to the UPS output as a temporary rise in current.

The UPS has no way of protecting the node power input from this type of line fault. Avoiding power glitch related node resets requires keeping the node's internal logic power bus within operating tolerances during the disruption to input power. Node vendors are experimenting with internal capacitors and batteries to this end. Capacitors should prove effective for short power disruptions of no more than a few 60 Hz AC cycles (60 to 70 ms). Extended hold-up times may require an internal battery or second power input to the node. Neither option is desirable. Internal batteries would require eventual replacement, and a redundant second power input is complex and expensive.

### 3.3. Utility Grid Backup Requirements

Increased power consumption from new R-PHY installations requires a review of UPS runtime capacity. With new architectures and equipment, what is the net effect on power consumption? Do the UPS systems still meet minimum runtime requirements? Operators must evaluate their networks by the criticality of each location. New R-PHY nodes may service business customers requiring longer utility backup than residential customers.

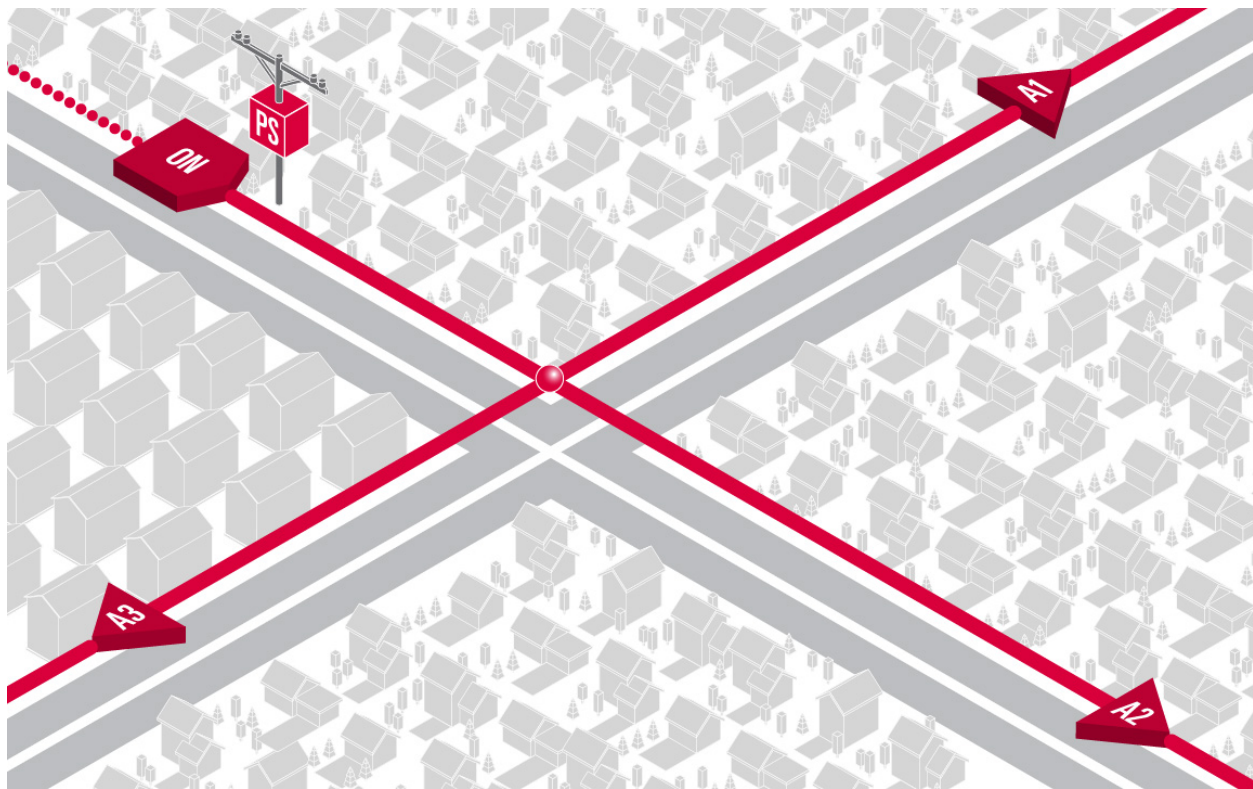
One utility power backup exception that California-based operators must address is described in State Senate Bill No. 431 introduced in June 2019. This bill requires some telecommunications equipment in high fire threat areas to support 72 hours of communications during utility outages. If this legislation is applied to cable operators, extensive upgrades to their power backup systems will be required. For the access network, this would likely require UPS systems to be fitted with extended runtime batteries such as lithium ion; alternatively, natural gas or propane generators could be used.

## 4. Powering 5G Small Cells from the Access Network

Using the access network to provide power and backhaul for distributed small cells seems like a perfect fit. Access network radio installations come with new powering challenges. We will review two specific RAN powering challenges: power capacity and voltage reach.

### 4.1. Access Network RAN Powering

RAN deployments are highly engineered solutions and specific to individual locations and situations. Our example is not comprehensive. We will review one simplified case intended to illustrate basic powering considerations. Let's begin with a block diagram depicting a neighborhood serviced by a broadband access network as shown in Figure 5.



**Figure 5 - Access Network Powering Example**

The diagram depicts a single ON with a fiber optic input and a single coax segment output. A coax splitter near the traffic intersection splits the coax in three directions. At some distance from the splitter down each of the three coax segments, amplifiers (A1, A2 and A3) boost the RF signal. A power supply (PS) located near the ON provides battery backup power to the ON and to each amplifier through the powered coax. What is not shown in the diagram are multiple splitters used to branch the coax segments into the residential areas where taps and associated drop cables connect to individual customer premises. Actual network installations are more complex than shown. However, our simplified illustration is sufficient to highlight a few key powering principles.



For this example, assume the following:

- The ON is an R-PHY node and requires 170 W power.
- Amplifiers A1, A2 and A3 require 80 W each to operate.
- The PS is rated at 1350 W and is configured for 90 VAC output.
- All coax is 0.625 inch cable with typical resistance of 0.0011 ohms per foot.
- Coax span lengths are shown in Table 3:

**Table 3 - Cable Span Lengths**

SPAN	COAX LENGTH (FT)
ON to Splitter	900
Splitter to A1	1,100
Splitter to A2	1,100
Splitter to A3	1,100

For simplicity we ignore any additional factors including resistance from various splitters servicing neighborhoods. With these parameters we calculate the power as follows:

$$P(\text{Actives}) = P(\text{node}) + P(A1) + P(A2) + P(A3)$$

$$\text{Total Power (Actives)} = 170 \text{ W} + 80 \text{ W} + 80 \text{ W} + 80 \text{ W} = 410 \text{ W}$$

Adding coax line loss or I<sup>2</sup>R loss adds an additional 11.6 W. The results are summarized in Table 4:

**Table 4 - HFC Powering Before Small Cells**

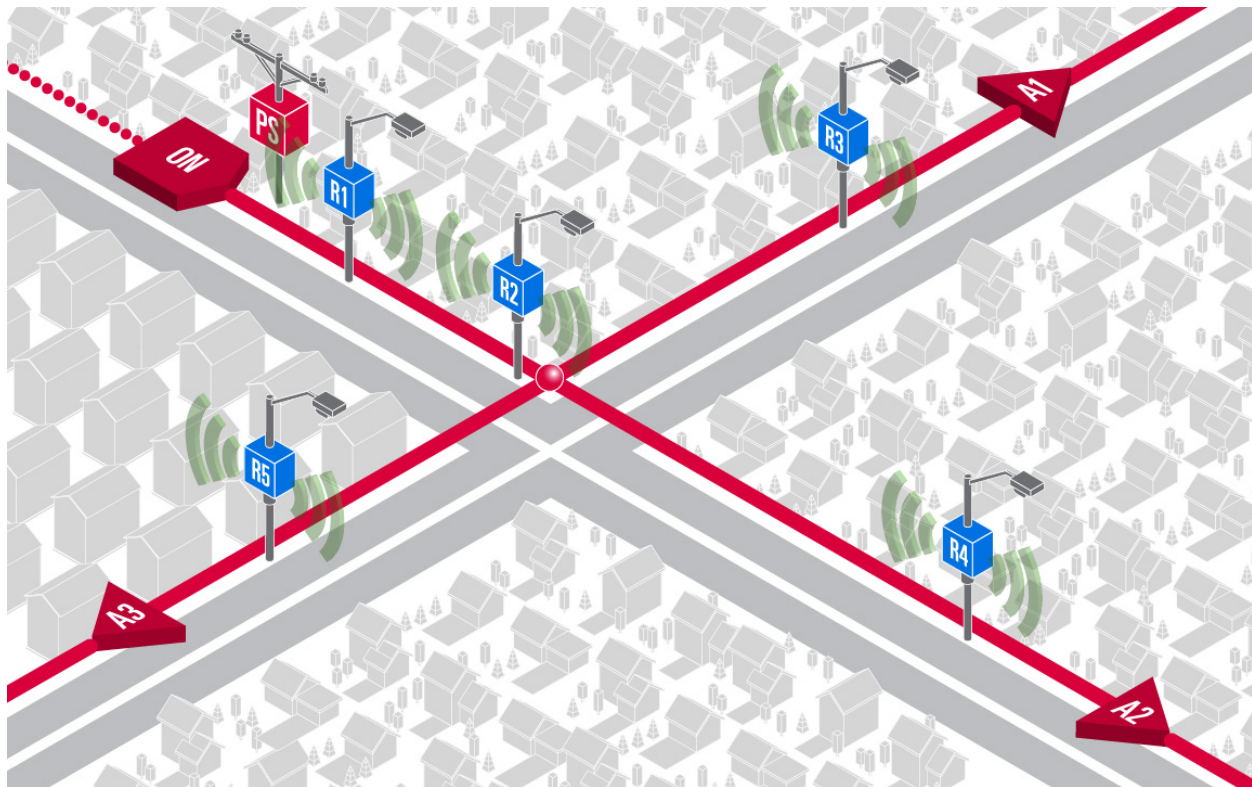
Configuration	PS I(out)	EOL Voltage	Actives Load	I <sup>2</sup> R Loss	PS Utilization
R-PHY Node with 3x Amplifiers	4.7 A	85 V	410 W	11.6 W	31%

In this example the network has plenty of reserve power for expansion.

## 4.2. Adding Small Cells Radios

Let’s now overlay 5G small cell radios into our access network. In actual RAN implementations radio placement is based on multiple factors including terrain, nearby structures, and suitable installation sites. Our RAN overlay example is intended to illustrate powering concepts and does not approximate any specific cell coverage. Using power and radio spacing information from several CBRS radio manufacturers we assume each small cell site requires 120 W to operate; this includes 15 W for an

integrated DOCSIS backhaul modem. Radio spacing depends on multiple factors and could be between 600 ft and 900 ft. For our example we assume 800 ft between radios. Figure 6 shows our access network overlaid with five small cell radios. Each small cell is coax powered and includes a DOCSIS backhaul modem.



**Figure 6 - Access Network Small Cell Powering Example**

For this example, power is calculated as follows:

$$P(\text{Actives}) = P(\text{ON}) + P(\text{A1}) + P(\text{A2}) + P(\text{A3}) + P(\text{R1}) + P(\text{R2}) + P(\text{R3}) + P(\text{R4})$$

$$P(\text{Actives}) = 170 \text{ W} + 80 \text{ W} + 80 \text{ W} + 80 \text{ W} + 120 \text{ W} + 120 \text{ W} + 120 \text{ W} + 120 \text{ W} + 120 \text{ W} = 1,010 \text{ W}$$

Factoring in coax line loss or  $I^2R$  loss adds an additional 95.7 W. It is worth noting that our pre-radio  $I^2R$  loss calculation became obsolete when the radios were added. Power draw from each added radio increases current through each associated coax span. This in turn reduces line voltage which in turn, causes our constant power load equipment to draw more current. The additional current further contributes to  $I^2R$  losses. The results are summarized in Table 5:

**Table 5 - HFC Powering with Small Cells**

Configuration	PS I(out)	EOL Voltage	Actives Load	I <sup>2</sup> R Loss	PS Utilization
R-PHY Node, 3x Amplifiers, 5x Small Cell	12.4 A	78 V	1,010 W	95.7 W	82%

This example illustrates the effect of I<sup>2</sup>R loss on network power consumption. In our pre-radio calculations, the UPS was loaded to only 31% capacity. Adding five small cell radios and considering coax line losses caused our UPS utilization to reach 82%. This is beyond the design limits allowed by operator policies. Our EOL voltage (78 V) is well within tolerance. EOL voltage can become the limiting factor when added coax span distances to powered equipment results in sufficient voltage drops through the coax to reduce the EOL voltage to critical levels.

Options to correct our overutilized UPS example include:

- Re-size the UPS with a higher capacity model
- Re-design some portion of this network segment to be powered from an adjacent network segment with enough power to handle the added load
- Install additional UPS equipment to meet the added power requirements

## 5. Conclusions

Traditional access network powering was reviewed and used as a baseline to illustrate how adding network upgrades including R-PHY nodes and powering 5G small cells can affect access network power.

Several power related concepts became apparent as different access network scenarios were reviewed:

- Experience with powering of traditional HFC networks is foundational. An understanding of both active loads and I<sup>2</sup>R losses is needed to analyze power demands of network upgrades. Coax line losses are a major factor in powering decisions, especially as new active devices are placed some distance from the UPS.
- Digital line gear including R-PHY nodes require more power than their analog predecessors and they are more sensitive to power disruptions. An R-PHY node reset has the potential to drop many customers for several minutes as processors reset and communications are re-provisioned. Policies regarding power quality, redundancy and backup time should be established to avoid related outages.

This paper reviewed only a few representative network powering concepts. Network powering must be engineered in connection with the network architectures being powered to ensure that power quality and quantity are sufficient for the near future network requirements.

## 6. Abbreviations

10G	10 gigabit
5G	fifth generation technology standards for cellular networks
A	ampere
AC	alternating current
ASIC	application specific integrated circuit
CBRS	citizens broadband radio service
CPU	central processing unit
DAA	distributed access architecture
DOCSIS	Data-Over-Cable Service Interface Specifications
EOL	end of line
FDD	[extended] frequency division duplex [DOCSIS]
FDX	full duplex [DOCSIS]
FMA	flexible MAC architecture
FPGA	field programmable gate array
Gbps	gigabits per second
GHz	gigahertz
HFC	hybrid fiber/coax
Hz	hertz
I	current
MAC	media access control
MDU	multiple dwelling unit
ms	millisecond
MHz	megahertz
ON	optical node
P	power
PS	power supply
R	resistance
RAN	radio area network
RF	radio frequency
R-PHY	remote physical layer
SCTE	Society of Cable Telecommunications Engineers
UPS	uninterruptible power supply
V	1) volt; 2) voltage
VAC	volts alternating current
W	watt

## 7. Bibliography and References

- [1] CableLabs, "10G: The Next Great Leap in Broadband," 2019.
- [2] CableLabs, "DAA (Distributed Access Architecture)," [Online].
- [3] CableLabs, "Data-Over-Cable Service Interface Specifications, DOCSIS® 4.0, Physical Layer Specification, CM-SP-PHYv4.0-I02-200429".
- [4] J. Chapman, "Blueprint for 3 GHz, 25 Gbps DOCSIS® Getting 25 Gbps PON-Like Performance out of HFC," SCTE, Cable-Tech Expo, 2019.

DOCSIS® is a registered trademark of Cable Television Laboratories, Inc.

# GAP and the Future Of Telecom Networks

A Technical Paper paper prepared for SCTE by

Bill Beesley, Chief Architect, MSO Strategy and Planning, Fujitsu, SCTE Member  
2801 Telecom Parkway  
Richardson, TX, 75082  
bill.beesley@fujitsu.com  
972.479.2098

## Table of Contents

<b>Title</b>	<b>Page Number</b>
Table of Contents _____	39
1. Introduction _____	40
2. What is GAP? _____	40
3. Solving the problem through disaggregation _____	41
4. The role of other industry initiatives _____	42
5. Looking to the future of GAP _____	43
6. Conclusion _____	45
7. Abbreviations _____	45

## 1. Introduction

The US cable networks represent the largest private real estate investments in the world, with massive areas already occupied by HFC infrastructure assets. The soon-to-be-released SCTE GAP standard presents not only opportunities to lower CAPEX and OPEX costs through standardization and reuse but also to create new methods to deliver services and revenue streams.

The first use cases for GAP will clearly be driven by remote PHY and MAC/PHY deployments. This paper explores beyond these initial use cases and discusses the future use cases envisioned by operators and technology providers as GAP enclosures are utilized to house deeply distributed access and antennas, edge compute, and packet aggregation technologies. The paper discusses how the convergence of SDN/NFV, DAA, edge compute, and now GAP will further expand use cases beyond these technologies to leverage the massive real estate assets that are unique to MSO networks and create new as-a-service models and revenue streams for cable operators.

## 2. What is GAP?

A few years ago, SCTE kicked off the GAP working group project. The intent of the project was to develop standards for the form factor of active outdoor equipment used to deliver services to end customers. Before GAP, a manufacturer wanting to develop service delivery equipment such as an HFC node or strand-mount radio for cable networks was required to design a fully integrated solution consisting of the outdoor enclosure and internal components. Since each application use case has been a unique design, this has created two problems for cable operators. First, there is no component reuse between multiple vendors' systems or often even across different systems from the same vendor. This means the operator must spare multiple versions of internal components such as power supplies, backplanes, and service modules as well as the outdoor housings. Second, , since each service module from different vendors is a unique design, an effect known as "strand bloat" is created in which there is no integration between systems and each much occupy its own real estate in the outside plant. The lack of reuse is not only economically and operationally inefficient; it also holds back innovation in service delivery equipment. One supplier might have a better way to build a more power-efficient radio or another might develop an enclosure that provides better thermal performance, but unless those suppliers are building the whole system, it is difficult for them to introduce their innovation to the industry.

The consequences of this barrier to innovation can be understood when compared to the x86 standard, which enabled the creation of reusable components that led to the modern personal computer ecosystem.



The innovations that came out of this standard were not only in the components themselves, but also in the way we use them. Without the innovations and cost reductions that evolved out of the x86 standard, much of the modern digital ecosystem –including our ability to conduct business remotely during a pandemic – would not exist. Similarly, GAP will not only drive down costs in the network, but it will also drive innovation and create new services and revenue opportunities.

### 3. Solving the problem through disaggregation

The GAP working group comprises representatives from both operators and equipment manufacturers and suppliers. These representatives began the task of creating commonality and agreement as to how active outdoor equipment was designed, packaged, and operated, by breaking the systems down into four discrete components.

The ubiquitous clamshell design already widely deployed and well understood was used as a starting point. This system was further divided into the housing, power supplies, backplanes, and service delivery modules. Subgroups were then created around these systems to work both individually and in collaboration with one another.

Housing was split into two definitions: the base, which would typically attach to the RF plant and therefore most likely contain RF modules such as amplifiers, HFC nodes or RPDs; and the lid, which would mostly commonly contain service delivery and compute systems.

Power supplies were defined as modular components so that manufacturers could support not only the HFC-powered systems common in cable plant, but also other powering methods such as AC or DC mains. This was intended to allow equipment designed to the GAP standard to be portable across HFC plant, in-building, or pole-mounting, and also across different regions of the globe and among service providers other than MSOs who do not commonly use HFC powering. Portability across multiple telecommunications use cases was determined to be a critical part of the future adoption and longevity of GAP.

Backplanes to allow module-to-module connectivity, as well as connectivity to the power supply bus, were also defined. There is a backplane definition for the base, which includes the connectivity for the base modules as well as to the power supplies, and connectivity from the base to the lid. For the lid, two different backplane definitions were developed, one supporting up to six service modules and one supporting up to four service modules plus a compute module for system processing and function virtualization. This

optional compute module is intended to support vCMTS, wireless DU, or other virtualized network functions, as well as edge compute use cases.

Lastly, module definitions were created to support RF modules in the base, as well as service and/or compute modules in the lid. Here the working group envisioned not only current outdoor components such as HFC nodes and amplifiers, but also emerging and future use cases. Distributed access architecture components such as remote PHY, remote MAC/PHY, and remote OLTs are supported. In addition, use cases such as passive and active optical networks and Ethernet aggregation, business services, Wi-Fi, and wireless mobility, as well as edge computing were also considered when designing the modules portion of the specification. As mentioned previously, the GAP standard specifies the size and form factor of the modules, with backplanes supporting either up to four or six modules depending on whether the operator elects to include a compute module. However, the specification does not limit a module to a single size; manufacturers are at liberty to design modules that span multiple slots in order to support larger thermal loads than a single module can support. This means that GAP nodes will serve both single-use cases, such as a wireless radio, and multi-use cases, such as an RPD with an Ethernet business services aggregation box and a passive DWDM multiplexer. This will allow service providers to work with their vendor ecosystems to ensure flexibility in use case definitions, as well as component reuse for sparing and inventory purposes.

In addition to the mostly mechanical definitions above, the GAP standard also includes baseline communications and YANG specifications to ensure support for inventory and management of field deployed components and systems.

The GAP standard will include a set of reference design drawings for each of the systems. This documented set of standard mechanical drawings will allow vendors to more easily utilize third-party components, such as enclosures or power supplies, but it will not prevent system suppliers from creating vertically integrated systems where they design all the components for an outdoor enclosed service delivery system as they do today.

#### **4. The role of other industry initiatives**

Virtualization, cloud containers, server automation, and software-defined networking have been migrating out of the IT and data center worlds, and network operators have been taking advantage of the efficiencies and scalability offered by these technologies. Telecom networks are morphing from provisionable elements into programmable infrastructure that can be managed as software. Alongside this, DAA is beginning to

evolve the HFC network into a metro-wide distributed Ethernet network with edge coax drops to the customer. The GAP working group had these in mind when they defined baseline communications and YANG models to allow for SDN, NFV and cloud-based infrastructure to coexist more easily with future network element deployments. It is this forward-looking thought process that ultimately will make GAP much more than just an inexpensive reusable commodity in the outdoor network.

## 5. Looking to the future of GAP

As previously stated, it is expected that the first use cases supported by the industry will be traditional HFC nodes or amplifiers as well as remote PHY and MAC/PHY deployments. This will allow the industry to begin deploying the distributed access architectures needed today while ensuring future flexibility to expand use cases. A remote PHY node could be upgraded in the future by adding a wireless or other service module. This will allow the GAP enclosures attached to the outside plant to evolve without having to be forklift-removed and replaced. More efficient or higher-current power supplies can be swapped out. Backplanes supporting future higher-speed communications can be upgraded and service modules can be added or upgraded as access services, such as new wireless radios or higher speed Ethernet, evolve in the future.

But the most exciting and interesting opportunity that GAP creates, along with cloud-native infrastructure, is the opportunity to further leverage the outside-plant network by re-envisioning it as “real estate.”

Let us take 5G wireless as an example use case. Much of the promise of 5G is future use cases that require high bandwidth, low latency connectivity. Autonomous vehicles are one popular example. Here, we are not talking about the driverless electric vehicle you may have purchased with Bitcoin but rather automation use cases such as driverless trucks and other vehicles performing mining operations. The vehicles will need a geographically broad, high bandwidth, low latency, and highly available network in order to realize centralized control and coordination or perhaps even true autonomy. In order to accomplish this, we will not be able to fall back to large, centralized RAN systems on big towers. The radio network needs to be composed of highly distributed small radios, perhaps with some edge compute to allow network processing of vehicle control at the edge to improve latency. To support this use case, a GAP deployment with a two- or four-sector small cell, an edge compute module, and a cable model or OLT for transport could be deployed, managed, and maintained by an operator as a service to the mining operator.

Another future wireless use case is enterprise wireless-as-a-service. Many large corporations, including my employer, operate on large corporate campuses that are notorious for wireless dead zones. Operators could provide wireless radios to improve coverage but with GAP they can provide even more value to large

enterprise customers with an as-a-service model by using 5G network slicing. In this use case, we might deploy a GAP node with a small cell radio, edge switch, compute and passive DWDM transport. With network slicing, we could implement edge routing rules running as an NFV on our compute to determine the identity of the user radio or handset that would be connecting. We then would provide an interface to the customer IT department whereby they could set up both walled-garden and corporate access to resources such as file shares or printers. When the subscriber would connect, the GAP node would determine if they are an employee or a guest and then would provide routing to the appropriate resources. Visibility and control would be given to the customer, to provide reporting and trust. This use case would be very difficult to support with current centralized RAN systems, but it becomes feasible with a string of GAP nodes deployed on or around a corporate campus.

As previously mentioned, in order to realize the promise of 5G, radios will need to become deeply distributed. Operators are now talking about a future network in which there would be a small cell every 100 homes passed. That is an audacious goal for traditional wireless carriers that will require them to negotiate millions of new pole and building attachments. But cable operators already have the strand real estate assets built out to the majority of homes in North America. With GAP, placing small cells will be as simple as adding a wireless module to an existing R-PHY node. This will greatly empower the MSOs to make use of CBRS offloading for their MVNO offerings, generating enormous cost savings. 5G slicing also would provide cable operators the potential to offer a “slice” of the radio on demand to other wireless operators, creating yet another potential revenue opportunity. Armed with millions of distributed radio assets it is not hard to envision some large MSOs eventually becoming the dominant wireless operators.

The last future use case I will outline is what the industry is calling “fog computing.” We have all heard the term “cloud computing,” which in a sense is “just someone else’s computer,” but in all seriousness, it is much more than that. Use of cloud compute, whether it is a public or private cloud, means the compute resources are scalable. If a task needs more CPU or memory, then cloud management systems can allocate these on an as-needed basis. Today, the majority of these clouds are very centralized, making them susceptible to high latency to the end user. But with fog computing, we distribute the cloud to the edge of the network, very close to the customer, which reduces latency. This is another arena in which the cable operator reigns supreme—no other operator in North America has the available strand assets that MSOs have to deploy widely distributed compute close to the customer. By using GAP to leverage the outdoor deployments of compute and virtualization, we could “rent” slices of that compute back to cloud providers, so that they can instantiate their service close to the customer to obtain ultralow latency. This would be highly useful for cloud gaming providers, SD-WAN, IoT, and other applications that can benefit from high

bandwidth and ultra-low latency. With enough GAP-based compute nodes deployed in their networks, MSOs could even become a dominant force in the cloud compute industry and monetize access to their customers back to the traditional cloud companies.

## 6. Conclusion

It is clear to everyone involved in the working group that once GAP-based solutions become available on the market, GAP will naturally become the standard for network deployments for MSOs. One MSO network vice president shared with the GAP working group that once the specification is available, that MSO will not consider any vendors who do not support it. It is also easy to assume, because the GAP working group made every attempt to make the standard portable to customers outside the cable industry, that once the efficiencies and flexibility offered by GAP are realized, other non-cable telecom providers will also take advantage of it. GAP is inevitably going to become the *de facto* standard for outdoor deployments. When that happens, the innovations it drives will allow operators to realize new revenue streams by thinking of their network as real estate they can rent out on demand.

## 7. Abbreviations

5G	fifth generation
AC	alternating current
CAPEX	capital expenditures
CBRS	citizens broadband radio service
DAA	distributed access architecture
DC	direct current
DU	distributed unit
DWDM	dense wavelength division multiplexing
GAP	generic access platform
HFC	hybrid fiber coaxial
IT	information technology
IoT	Internet of things
MAC	media access control
MSO	multiple-system operator
MVNO	mobile network virtual operator
NFV	network function virtualization

OLT	optical line terminal
OPEX	operating expense
PHY	physical layer
RAN	radio access network
RPD	remote PHY device
R-PHY	remote PHY
SCTE	Society of Cable Telecommunications Engineers
SDN	software defined networking
SD-WAN	software defined wide area network
US	United States
vCMTS	virtual cable modem termination system
WiFi	wireless fidelity
YANG	yet another next generation

# Cable Operator Operational Considerations To Reach 10G Access Networks

A Technical Paper prepared for SCTE by

Dr. Sudheer Dharanikota, Managing Director, Duke Tech Solutions Inc.  
[sudheer@duketechsolutions.com](mailto:sudheer@duketechsolutions.com)  
+1-919-961-6175

Dr. Luc Absillis, Chief Operating Officer, First Principles Innovations LLC  
[luc@fpinno.com](mailto:luc@fpinno.com)  
+1-919-345-2655

Rajesh Abbi, Principal Consultant, Duke Tech Solutions Inc.  
[Rajesh.Abbi@duketechsolutions.com](mailto:Rajesh.Abbi@duketechsolutions.com)  
+1-919-455-4787

## Table of Contents

Title	Page Number
Table of Contents	48
1. Document Overview	49
2. Executive Summary	49
3. Multi-trigger access transformation	50
3.1. Access transformational challenges	51
3.2. Operational challenges in detail	53
3.2.1. Operational resource challenges and mitigation	53
4. Access transformation scenarios	56
5. Detailed operational analysis	57
5.1. Material forecasting	57
5.2. Labor resource forecasting	60
5.2.1. Integrated transformation planning	64
5.3. Powering operational impacts	65
6. Recommendations	66
7. Acknowledgments	66
8. References	67

## List of Figures

Title	Page Number
Figure 1 - Access transformation evaluation dimensions	50
Figure 2 - TCO along with the right time scope is essential for the financial health of operators	52
Figure 3 - High-level operational analysis flow diagram	54
Figure 4 - Market level resource forecast for a ten-year fiber deep transformation strategy	55
Figure 5 - Three scenarios used in this paper to evaluate different operational impacts	56
Figure 6 - Access network material classification	58
Figure 7 - Impact of 1.8 GHz amp availability delays on the activities and the material needs	59
Figure 8 - End to end access network deployment and maintenance labor classification	61
Figure 9 - Understanding the impacts of the access transformation strategies on the labor needs	63
Figure 10 - Integrated greenfield and brownfield planning is essential for efficient use of resources	65
Figure 11 - Access power network options are directly dependent on the choice of transformations	65

## List of Tables

Title	Page Number
Table 1 - High-level material related metrics against classes of material	60
Table 2 - Different operational levers to address metrics against the labor classification	62



## 1. Document Overview

### What is the problem?

Cable operators are racing towards 10G capable access networks. There are multiple paths to reach the end goal, each posing different operational challenges. How to evaluate operationally suitable option for the operator?

### Key Takeaways:

Operators need to evaluate if they can execute on the access transformation plan. This needs careful evaluation of the labor and material needs due to the plan. To gain the operational confidence, we recommend that operators adhere to the following guidelines:

1. Start with proper resource forecasting
2. Remember to do integrated planning
3. Optimize deployment and maintenance
4. Define and manage to the metrics

Key words: Labor, material, efficiency, deployment, and maintenance

## 2. Executive Summary

Cable operators have many options to reach their target 10G platform rollouts [1]. These options need to be evaluated against the current state of their networks and the three dimensions related to their access evolution – their financial, architectural, and operational constraints. In our previous paper [2] we discussed in detail the financial considerations of the 10G transformation. We provided the cable industry many documents on the architectural choices in migrating to the target 10G access [3], [5], [6], [7], [8]. In this paper, we discuss the equally important third dimension, the operational considerations in 10G access transformations.

The operational analysis is essential for the access transformation planning, which answers the basic question – can we execute the proposed transformation plan with minimal risk? The execution, as opposed to many operational plans, should include both the commonly considered deployment and rarely considered maintenance. The operational plan mainly includes labor and material resource planning. The fundamental question in labor planning is “can we execute the plan efficiently?” The question in material analysis includes “is the availability of the newer technologies stable enough to be deployed in large scale?” These operational considerations are presented in the paper.

Managing the in-house and contract labor resources can be very challenging. All labor resources need to be planned thoroughly and must be managed through a suitable organizational structure for their efficient use. In addition to the operational considerations, we discuss some of the planning challenges along with some mitigation options using example scenarios. We will show how the use of integrated planning (brownfield, greenfield, overlay, business etc.) - including end-to-end labor considerations (both deployment and maintenance) – is essential while planning for these resources.

In summary, in this series of articles that we provided in the SCTE Technical Journal, we make the case that the access transformation must be evaluated from the financial, architectural, and operational points of view.

### 3. Multi-trigger access transformation

To reach 10G [1] platform-capable access networks, operators have many inside plant (ISP) and outside plant (OSP) options as discussed in [2]. Investing in these access transformation initiatives is a multi-billion dollar business. As shown in Figure 1, many stakeholders in the organization have vested interests in these initiatives. As discussed extensively in [2] the financial team is heavily involved through optimizing total cost of ownership (TCO). Naturally, the product and the engineering teams have vested interests in creating revenue-generating product offers and in meeting the natural customer demand growth. Some of these topics are covered in this paper. A detailed interaction of the demand growth and the product offering on the access transformation strategies can be found in [3]. Finally, the operational team needs to bless the access transformation strategy from the *executability* of the plan. Typically, the operational aspects in the transformation plans are evaluated as an afterthought. In this paper, we analyze this less explored topic of operational analysis and its impacts on long-term strategic plans.

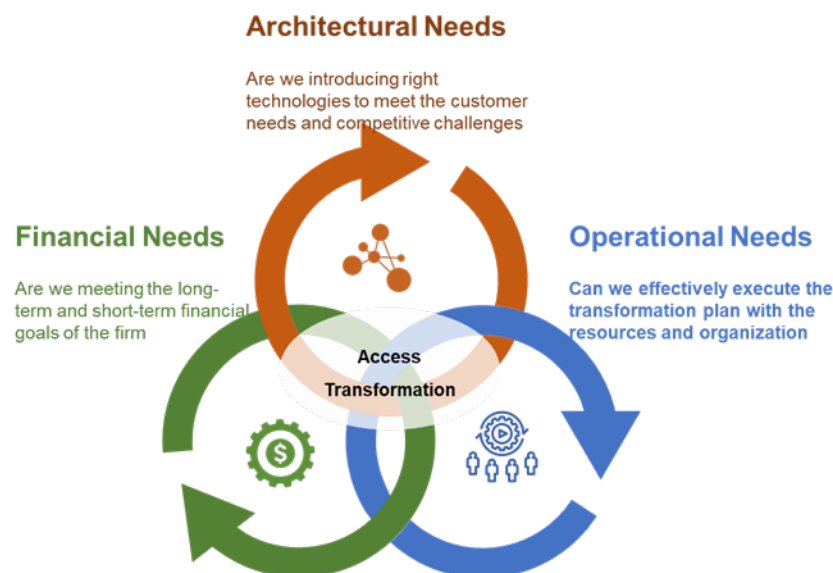


Figure 1 - Access transformation evaluation dimensions

**The “Triangle of Truth” – HFC Use Case Error!** Reference source not found.

Access capacity is based on three mechanisms – also known as the “Triangle of Truth” – increase the available spectrum, effectively use the spectrum and reduce the spatial scope of the spectrum.



For example, let’s say you are using X GHz spectrum on an HFC network. Then

$$\text{Bandwidth per sub} = \frac{\text{Total capacity of this HFC}}{\text{Total Number of Subscribers}}$$

Total downstream Capacity for a 32D DOCSIS HFC @ 256 QAM = Spectrum \* Spectral efficiency = (32 \* 6 MHz) \* 8 bits/HZ = 1.536 Gbps

If there are 200 active subscribers on this HFC network, then

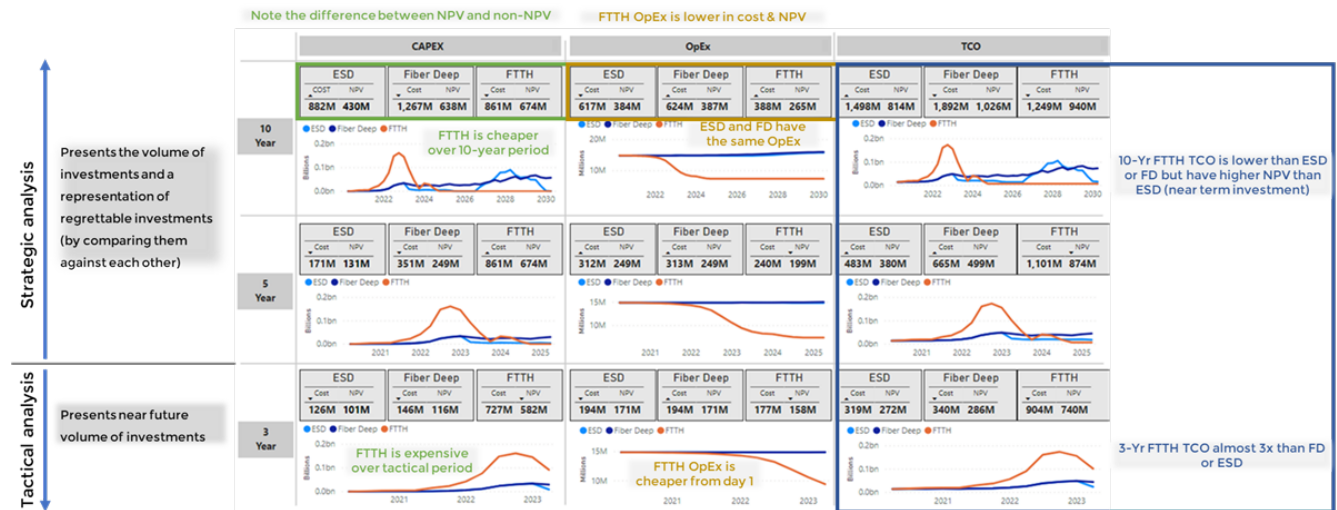
As noted above, a transformation plan must be analyzed from multiple dimensions (architectural, financial, and operational) points of view. We call this multi-trigger access transformation, as explained in detail in [3]. In section 3.1, we highlight some of the challenges faced by these three triggers.

### 3.1. Access transformational challenges

Access transformation [4] for Tier 1 operators is a multi-billion dollar investment initiative. We recommend that you refer to [4], [5], [6] for detailed discussions behind access transformations. In the rest of the section, we provide a very high level summary of the transformational challenges from architectural, financial, and briefly (more will be provided in the rest of the paper) from operational points of view.

**Architectural challenges** ([7], [8], [9]): The basic reason for brownfield access network upgrades is to meet the customer demand growth. Offering relevant products for competitive reasons is the other reason why access transformation will be performed. There are many ways these demands can be met through access upgrades; these are explained in detail in the access transformation basics references [7] and [9]. These are typically accomplished (refer to the insert – “*The Triangle of Truth – HFC use case*”) through increasing the capacity of the medium (spectrum upgrades, additional wavelengths etc.), reducing the number of subscribers supported on the shared medium (node splits, N+0 etc.), or by migrating to higher capability technologies (D3.1, FDx, FTTH etc.). All of these upgrade options offer different capabilities,

long-term evolution paths, and additional product offering capabilities. They come with different total cost of ownership (TCO) investment profiles. The greenfield deployments, on the other hand, will have different access TCO and offer capabilities [8]. For example, deploying fiber to the home (FTTH) is more feasible in greenfield compared to brownfield deployments.



**Figure 2 - TCO along with the right time scope is essential for the financial health of operators**

**Financial challenges** ([2]): Meeting the architectural challenges (customer demand growth and product offering needs) at an optimal long-term TCO is going to be the next challenge. This analysis is discussed extensively in our previous paper [2]. Evaluating the long-term TCO investment (CapEx and OpEx) profile in making the right decisions is important for the financial health of the operators. As shown in Figure 2 from the referenced paper, gaining strategic (long term) and tactical (short term) views of TCO are essential to align your whole organization and avoid regrettable access investments. Identifying regrettable investment is possible by analyzing long-term investment and operational costs. That is why we recommend that long-term TCO analysis [2] should become an integral part of any network upgrade decision.

**Operational analysis** (refer to the insert “What is included in Operational Transformation?”): Without solid evaluation on the merit of sound architecture and financial planning, strategies will not get realized without execution. Many of the access strategies face extensive risks for not analyzing the impacts of operationalizing the access networks. The operational analysis happens in two phases – during the initial *deployment phase* and later during the *maintenance of the network*. A breakdown of some of the components in these two phases is provided in “What is included in the operational transformation?” insert. The resources that are tapped in both phases are *the labor* and *the material* resources. Evaluating the availability of the resources and improving the efficiency of the resources etc. are essential for the success of the operational strategy. In the remainder of the paper, we provide the impact of access transformation strategies on the operational aspects.

**What is included in operational transformation?**

An access network operation happens when the network is being deployed and maintained.

*Deployment operations:* This typically includes – deployment labor (e.g., design, construction crews, installers etc.) and deployment material (e.g., cabinets, fiber, peds, passives etc.) resources consumed during the brownfield upgrades and the greenfield deployments.

*Maintenance operations:* This typically includes – maintenance labor (power maintenance team, field techs, in home techs etc.) and maintenance material (spares etc.) for the smooth operations of the network in alignment with service level agreements (SLAs).

### 3.2. Operational challenges in detail

Understanding the operational implications are difficult. There are too many unknowns when it comes to labor or material resources. In this section, we will dwell on the most important of these challenges and the mitigation options operators should use.

#### 3.2.1. Operational resource challenges and mitigation

Labor resources are critical for the operational success of any access transformation plan. Typical examples of labor issues include the sheer volume of activities, peaks and valleys of the resource needs, and the potential organization inefficiencies to execute the future transformational challenges. Also, it is common for planning teams to inadvertently *double-dip* into available resources by not doing integrated transformation planning. In the following discussion, we elaborate on these topics with the help of Figure 3.

**Are we performing integrated transformation planning?** As shown in Figure 3, the labor resource activities are driven by brownfield, greenfield, and other overlay (such as small cell services, 5G services, business service etc.) activities. Typically, the same resources are tapped irrespective of the transformation activities. For example, the permitting resource for a market will work with the municipalities irrespective of the greenfield or brownfield activities. Hence it is important to forecast the true volume of activities from the integrated (all-inclusive activities) planning point of view. This is the enterprise-level access network operational forecast. Note that the same step applies to material forecasting.

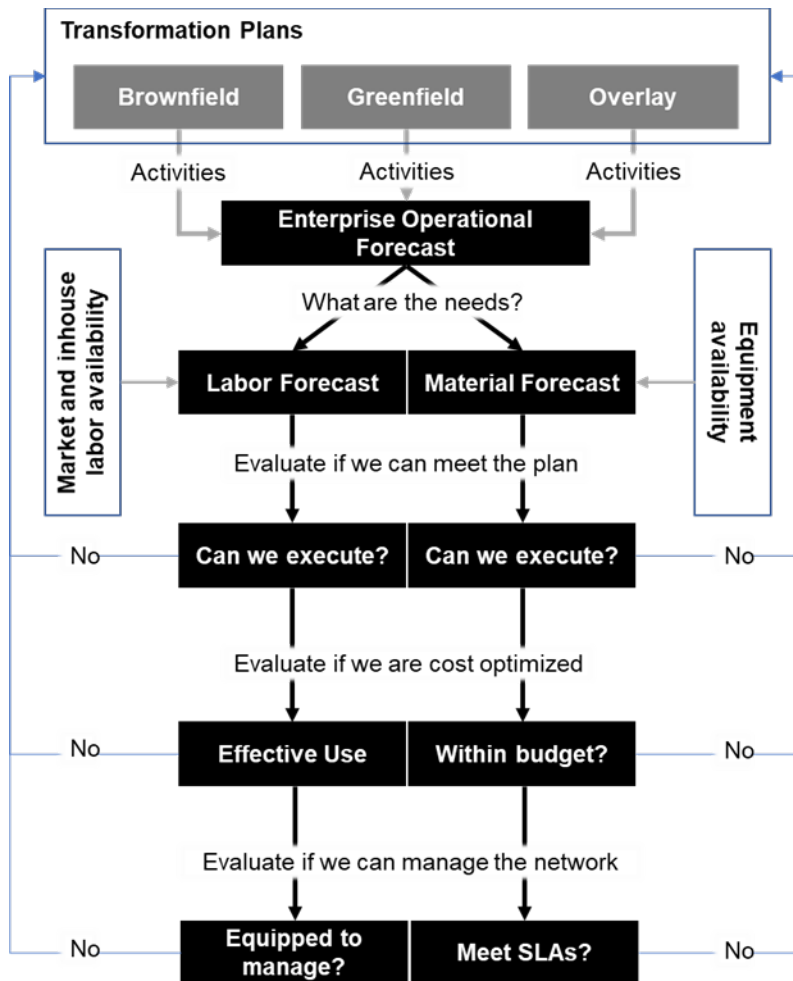


Figure 3 - High-level operational analysis flow diagram

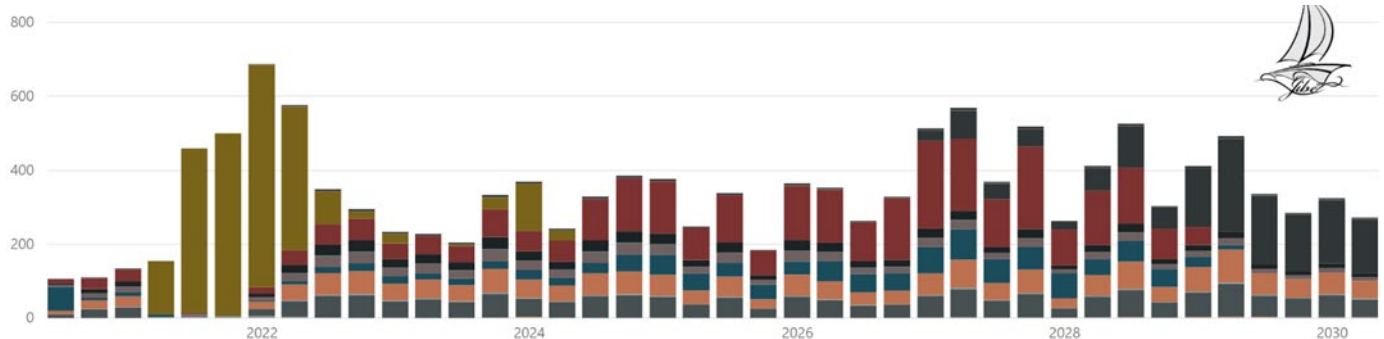
**Can we execute?** Validate if there is enough contract and in-house labor available to meet the operational forecast. If not, we need to go back and readjust the transformation plan. Similarly, make sure the material vendor commitments are available for the projected activities. If there are risks to the material plan, we need to readjust the plan.

**Are we effectively using the resources by meeting the budget forecasted?** Figure 4 shows a sample labor resource forecast for a market over a 10-year period. The labor forecast clearly shows peaks and valleys over the 10-year period. While planning these resources the operator needs to consider operational overhead (especially for the in-house labor), effective use of in-house and contract resources, and availability of key labor resources. Here are a few other considerations:

- Managing the labor need swings (peaks and valleys) are balanced by the in-home versus external labor mix, or through proper forecasting and confirmation of the qualified external labor availability.
- Overhead is normally on the in-house employees. The in-house resources such as PMs, designers, planners etc. are paid through the operator’s payroll. They can quickly

become a heavy overhead if they are not used efficiently. One of the mitigation levers used by operators is evolving the organization to effectively use the in-home resources. These levers include COE (center of excellence) vs. distributed resources vs. mixed organizations.

- These in-house and contract resources need to be used effectively. This includes reorganizing to meet the forecast needs and aligning activities to best utilize external resources (such as clustering the field activities to avoid commuting issues due to scattered activities).
- Introducing a new technology always creates a risk to the plan. The operator needs to wait for the general acceptance (GA) release of the product, analyze the lead times of the product and mitigate the deployment risk through staggered deployments.



**Figure 4 - Market level resource forecast for a ten-year fiber deep transformation strategy**

Finally, the operator needs to evaluate if they are **ready to maintain the future access network options** that access transformations teams planned. This support includes the labor and material (typically the spares) of the access services organizations. Are they trained? Are they equipped with the spares? Are the operators containing the number of deployed architectures and technologies that they are maintaining? Do not forget to optimize the long tail of maintenance.

Since these challenges are vague and subjective, making objective decisions requires definition of concrete metrics, as highlighted below.

**Material resource metrics:**

- *Technology availability risk:* Evaluates the impact of technology availability and its risks on the overall operational success of the transformation.
- *SLA guarantee risk:* The risk of impacting SLAs due to the potential for equipment failures.
- *Spares availability risk:* How to forecast and where to store the spares in meeting the SLA guarantees.

**Labor resource metrics:**

- *Labor efficiency (in-house and contract efficiency):* Measures how efficiently the operator is managing the in-house and the contract workforces. Also, the operator needs to balance the volume of in-house vs. contract labor through sourcing strategies.
- *Overhead per category of resource (organizational efficiency):* Reflects how effectively the operator is managing the workload of the internal resources.

- Deployment to maintenance ratio per labor category: The deployment decisions made now will drive the longtail maintenance risks of the access organizations. Analyzing the ratios is important for the overall health of the operational plan.

#### 4. Access transformation scenarios

Cable operators have many access levers to reach 10G capabilities as summarized in [2]. This paper is not intended to be a primer on access technologies. If you need additional information on the basics of access, brownfield, and greenfield upgrade strategies in detail we recommend you to refer to the white papers [9], [7], [8] respectively. Figure 5 gives the three end-to-end access scenarios that are being prominently evaluated by cable operators. These scenarios are used to show some of the operational choices cable operators need to make. Fiber deep (FD) and extended spectrum DOCSIS® (ESD) are used to compare the brownfield 10G evolution paths. Cable operators are at time of publication using fiber to the home (FTTH) for their greenfield deployments. We use FTTH in addition to ESD to briefly demonstrate the need for integrated planning. In the following analysis, we also evaluate OSP powering TCO to showcase how such a framework can be used from an end-to-end long-term operational perspective and at the same time can zoom into the detailed deployment-related decision making.

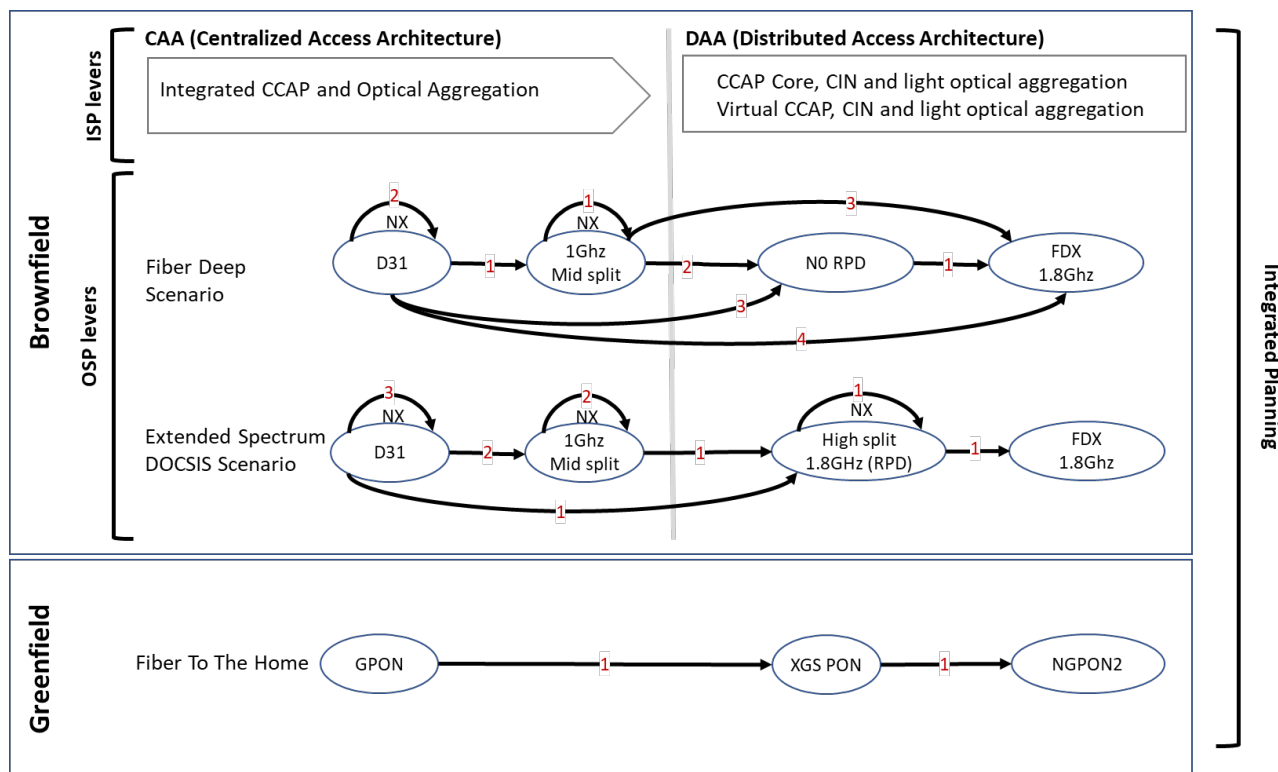


Figure 5 - Three scenarios used in this paper to evaluate different operational impacts

In these scenarios, we consider a fictitious network of ~2K nodes with 1 million homes passed in three markets in North Carolina. At the start of the analysis, all brownfield nodes and customers are DOCSIS 3.1, and the greenfield nodes and customers are GPON. Whenever a node makes a transition, as shown in Figure 5, relevant deployment-related resources (labor and material) are used. Maintenance, on the other



hand, is an ongoing investment into the network to meet the customer SLAs and manage the health of the network. Thus maintenance gets calculated based on the network state.

The following high-level assumptions are made in this analysis:

- Only HFC based options are considered for brownfield deployment analysis
- Out of the material and labor-related operational impacts we only elaborate on the labor portion; material impacts are cursorily discussed
- All future greenfield deployments are considered to be GPON based and are considered to demonstrate the need for integrated planning.
- Although the power impacts are end to end (including ISP, OSP, and in-home), in this paper we consider only the OSP operational impacts.

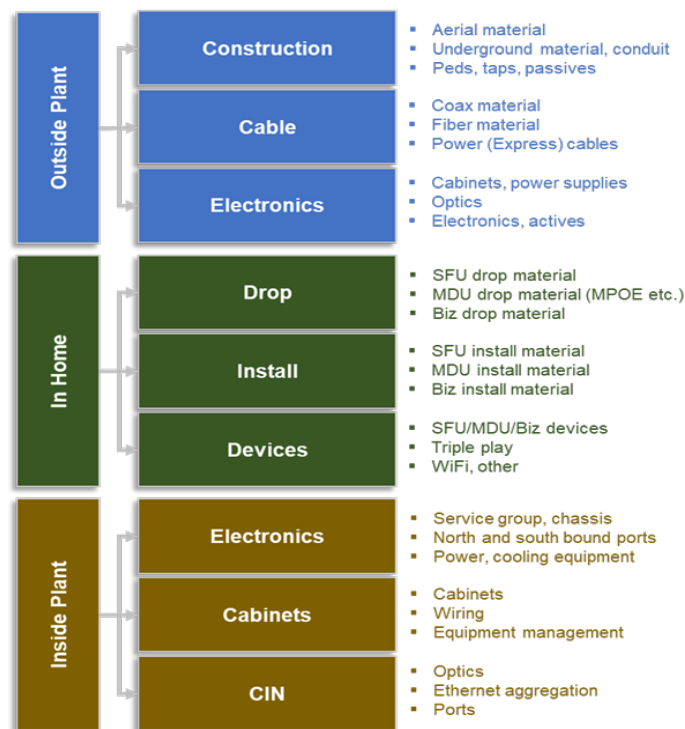
## 5. Detailed operational analysis

In the following section, we classify the material and labor resources into logical buckets so that we can forecast them properly and assess different operational strategies to meet the target metrics. We will discuss briefly, with ESD as an example, the material forecasting and risk mitigation strategies. Labor analysis will be performed in more detail with the help of ESD and FD. We use greenfield deployments with FTTH as a technology of choice, along with the above brownfield deployments to demonstrate the issues a cable operator is going to face if they do not perform integrated planning.

### 5.1. Material forecasting

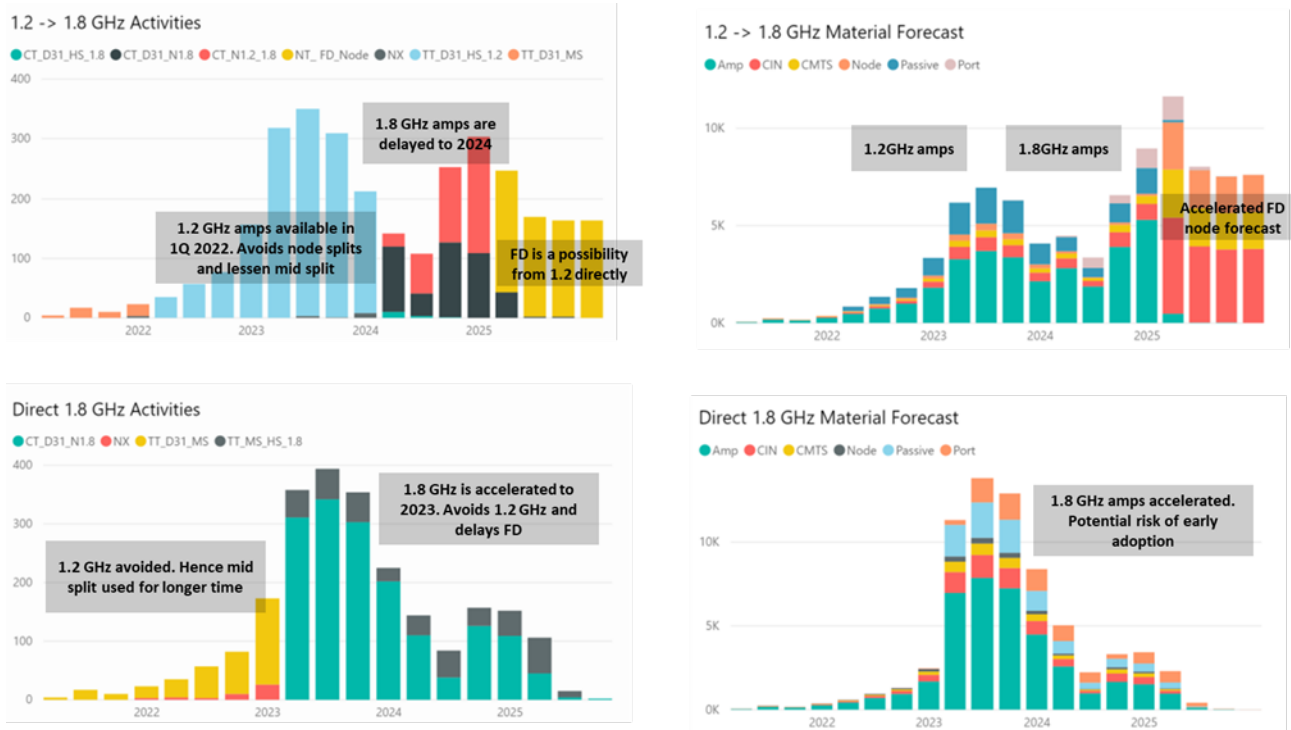
There are many ways to classify the material. The classification suggested, as in Figure 6, will assist operators in grouping the type of material, and identifies the duration of disruption (in turn the repair SLAs) due to failure. Such grouping can assist the operators in their sparing strategies. This classification also assists operators in assessing the availability and lead time impacts.

As shown in Figure 6, the material resources are classified into the outside plant (construction, cable, and electronics), in-home (drop, install, and CPE devices), and inside plant (electronics, cabinets, and Converged Interconnect Network(CIN)). Relevant detailed material for each group is presented in the figure.



**Figure 6 - Access network material classification**

The OSP material impacts due to one of the metrics, technology availability (such as the availability of 1.8 GHz actives), can impact the overall deployment schedules and hence the changes to the material forecasts. Figure 7 shows an example scenario showing the impact of delayed 1.8 GHz actives on material forecast.



**Figure 7 - Impact of 1.8 GHz amp availability delays on the activities and the material needs**

In this scenario we consider an ESD-based access network transformation plan. The best case would be going *directly to upgrade the plant and the devices to 1.8 GHz spectrum*. Here we assume that 1.8 GHz amplifiers are available by 1Q 2023. In this scenario we assume that a mid-split is used to meet upstream demand needs and node-splits for downstream and upstream growth. As shown in Figure 7, the material needs are driven by the forecasted activities. This plan has a risk of potentially deploying 1.8 GHz capable devices in a hurry (without proper technology trials) on a large scale. As an alternative, we could delay the deployment of 1.8 GHz by one year to Q1 2024 (until we validate the technology thoroughly) and in the meantime deploy 1.2 GHz capable technology from 2Q 2022. As can be seen in the transformation plan presented above, we can de-risk the program by upgrading to 1.2 GHz and later on going to 1.8 GHz. The downside of this strategy is that the operator would have two different access networks (1.2 GHz and 1.8 GHz), would need to trigger future options sooner, and would need to maintain spares/knowledge for both the topologies in the organization. The operator has to have a clear vision of the overall transformation strategy by considering these material-related operational impacts.

A similar analysis can be conducted on the availability of different technologies, their impact on the rollout of that technology, and hence the overall material forecast. Operators need to get a handle on these interdependencies. They also need to understand the risks involved in deploying different technology groups as shown above on the spares and overall maintenance of the access.

**Table 1 - High-level material related metrics against classes of material**

	Material Classification	Deployment Risk due to Availability	Scope of Failure Impact	High Level Sparing Strategy
ISP	Cabinet	Low	High	Per market
	Electronics	High	High	Per market
	CIN	High	High	Per market
OSP	Electronics (+ power supplies)	Medium–High	Medium	Per market/On the truck
	Cables (+ power cables)	Low - Medium	Medium	Per market/On the truck
	Construction	Low	Low	Per market/On the truck
In-Home	Drop	Low	Low	On the truck
	Install	Low	Low	On the truck
	Devices	High	Low	On the truck

Table 1 presents a very high-level view of the impact of different classes of material on the operational metrics. For example, a CIN network that connects the ISP electronics with the OSP node architectures is a fairly new invention for cable deployments. Hence the deployment risk is high due to the technology availability and the risk of longer duration for stabilization. Also, a failure of components will impact a larger customer base due to its position in the aggregation network. Because CIN components are deployed in the facility and sparsely in the field (and potentially have fewer active components), spares can be aggregated per market to meet the SLA guarantees. Thus grouping the material, for example, will assist in managing these resources to accomplish targeted metrics.

## 5.2. Labor resource forecasting

Like material, we classify the labor resources used for the deployment and the maintenance into different groups as presented in Figure 8. These groups are defined by keeping the final metrics (efficiency, overhead etc.) in mind. These groups are:

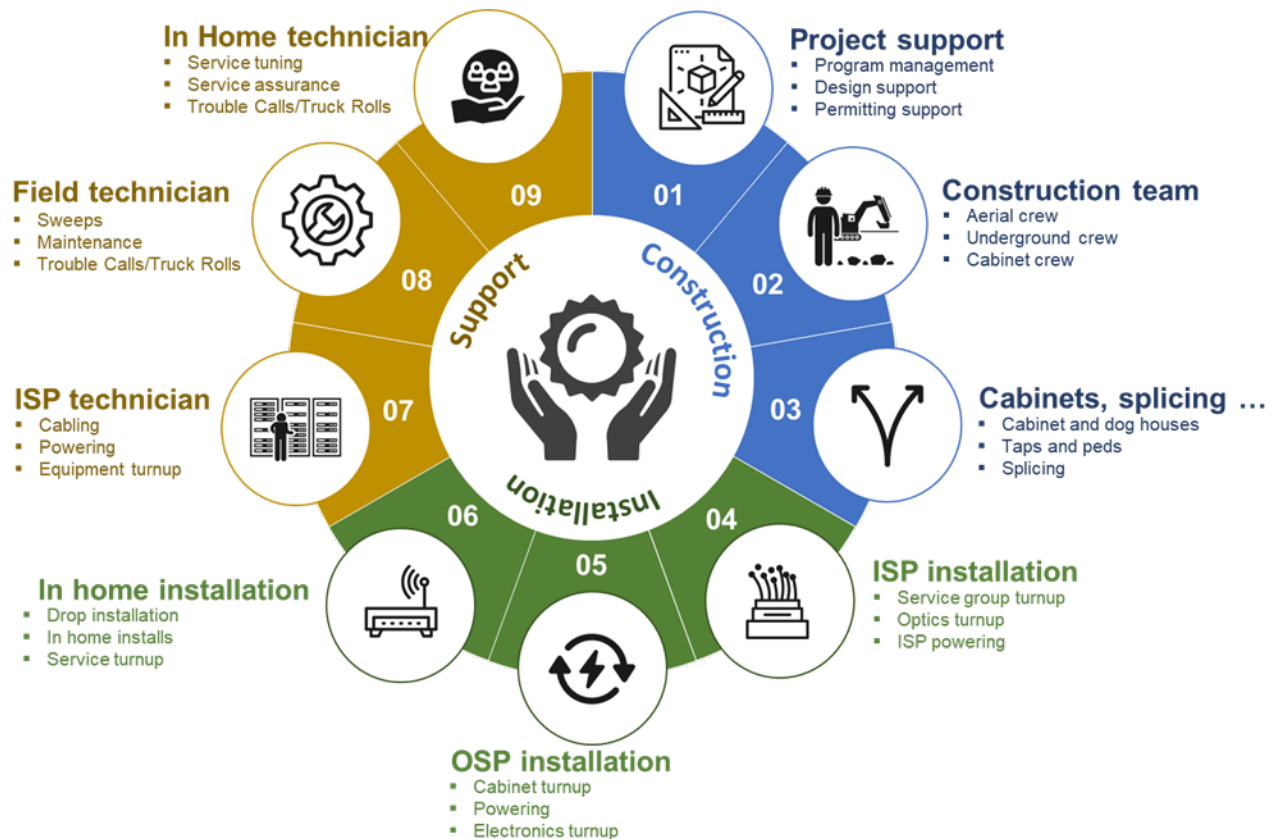
**Construction resources:** These are the construction resources that will include a mix of in-house and contract resources. These groups are used for evaluating different resource strategies based on the forecasted volume.

- *Project support:* These are the resources that can be centralized or grouped across multiple markets. Examples of such teams are the design, permitting support, and program management.
- *Construction:* The construction crew is boots on the ground. They are distributed and are forecasted per market as opposed to centralization. The efficiency of this crew is managed by reducing the inefficiencies in the plan.
- *Other construction:* These are the special resources such as splicers, cabinet installations, ped installation etc.; they are optimized through properly architecting the solutions.

**Installation resources:** These are the resources that are involved in deploying the next-generation technologies and solutions. The operational optimization of these resources is typically done by aggregating the activities and potentially reducing the installation touchpoints.

- *ISP installation:* This team installs in-facilities technologies such as CMTS, CIN, powering solutions etc. These are people with the knowledge to turn up the next-generation technologies. Typically, they are in-house resources.

- *OSP installation:* This team does the installation and turn-up of the field electronics, optics, cabinets, and powering solutions. These are typically highly qualified teams who work in tandem with the ISP installation team. They are also typically in-house resources.
- *In-home installation:* This team is responsible for the deployment of in-home solutions.



**Figure 8 - End to end access network deployment and maintenance labor classification**

**Support resources:** These are the resources that maintain the health of the access network. The operational optimization drivers of the support teams include the stability of the technology, manageable access architectures, fault isolation automation, and containing the impact of a failure.

- *ISP technician:* These are the team members who have access to the facilities and have a good understanding of the access architectures. They manage the aggregation networks, CMTS, CIN network, and powering solutions in the facility.
- *OSP technician:* These field services technicians are responsible for the maintenance of the OSP components (CIN, small cells, nodes, cabinets, powering, fiber cuts, cable sweeps etc.). This is the most-taxed maintenance team. The access organizations need to improve their efficiency using different tools, processes, and strategies.
- *In-home technician:* These are the team members who assist subscribers with their service issues through their care programs and potential truck rolls. The complexity of this organization is driven by the number of subscribers per service and the complexity of the services.

To understand the impact of the access transformation strategies, as shown in Table 2, we need to first evaluate what are the drivers behind activities per labor classification. Then we must identify how the

labor efficiencies can be accomplished and overhead can be reduced. Finally, the overall maintenance aspects of the transformation need to be considered in the operational analysis. If there are any risks against the resource classifications during the long-term planning period, it is essential to go back and reevaluate the plan. This operational evaluation must be part of the planning for the successful execution of the access transformation.

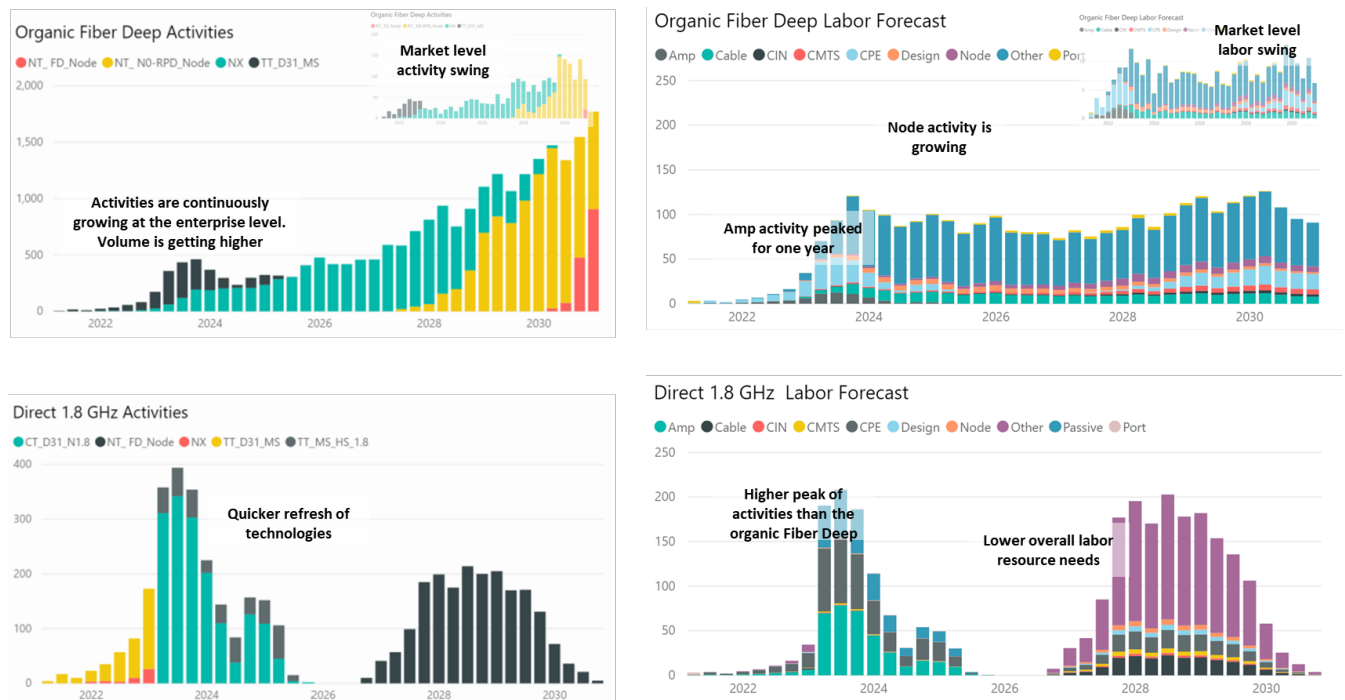
**Table 2 - Different operational levers to address metrics against the labor classification**

	<b>Labor Classification</b>	<b>Major Activity Volume Driver</b>	<b>Labor Efficiency Options</b>	<b>Overhead Considerations</b>	<b>Maintenance Considerations</b>
<b>Construct</b>	Project support	# of projects/ activities	Center of excellence vs distributed vs mixed	In home vs contract balance	NA
	Construction	# of miles constructed	Clustered construction	In home vs contract balance	NA
	Other	# units deployed/spliced	Architectural optimization	In home vs contract balance	Architectural simplicity
<b>Installation</b>	ISP installers	# shared groups deployed	Architectural options	Simplicity	Simplicity
	OSP installer	# of units turned up	Digital architecture	In home vs contract balance	Simplicity
	In-home installer	Net connects	Self-install, simplicity	Self-install	Simplicity, integrated
<b>Support</b>	ISP technician	# of ISP truck rolls	Simplicity	Simplicity	Simplicity
	OSP technician	# of OSP truck rolls	Less # of options, Telemetry	Less # of options	Less # of options, Simplicity
	In-home technician	# of in home truck rolls	Automation	Automation	Simplicity, automation

There are many options available for operators to devise operational efficiencies based on the groups of activities with which they are involved. These include:

- *Labor efficiency metric improvement:* Cable operators have many levers to improve the efficiency of their in-house and contract workforces per labor category. These include
  - Evaluating centralized organizations such as center of excellence (COE) vs. distributed organizations vs. a mixed option
  - Improving the contract labor efficiency through time optimization actions such as clustered construction activities
  - Using different architectural options (cabinet locations, powering solutions, connectorized solutions) and their optimizations to reduce the overall deployment and maintenance costs
  - Reducing the number of architectural options, simplifying installations, or enabling self-installation.
  - Automation.

- **Overhead (organizational efficiency) reduction:** Efficiently using the in-house resources so that the team productivity levels are maintained is critical for overhead reduction. These options include
  - Balancing the in-house versus contract resource levels
  - Centralizing the overall activity through automation
  - Simplifying installations and architectures
- **Maintenance cost reduction:** Typically, in many of the access transformation planning, the operational impacts are ignored. These might include maintenance impacts of the existing access infrastructure; the future deployment options being selected due to transformation strategy; and their maintenance complexity. This is a very tough problem to solve. We propose very few metrics (more of guidelines) for keeping these maintenance challenges in check. These include:
  - Architectural and deployment simplicity
  - Reducing the number of solutions deployed, and
  - Developing different telemetry-based monitoring and automated fault detection solutions



**Figure 9 - Understanding the impacts of the access transformation strategies on the labor needs**

In Figure 9, we show the impact of two different network upgrade strategies (fiber deep and ESD) on the labor resource needs for a sample brownfield access network. Note that the operator may use, as opposed to the simple two extreme solutions, many deployment strategies such as staggered deployments to counter the resource needs.

In the first scenario, organic fiber deep, node splits and N+0 techniques are introduced gradually. Such a transformation drives constant growth in the OSP construction activities and hence the constant growth in the labor resources (as shown in the figure). In the second scenario, spectrum upgrades to fiber deep construction, the market needs vary significantly from year to year as well as the types of activities. The following observations can be made from the forecasts:

- The enterprise-level forecast may be smooth, but the market-level labor resource needs can swing highly based on the activities. *It is important to note that labor resources are market-specific.*
- In fiber deep deployments, the constant growth of activities does not apply to all categories of the resources. For example, the amp activity in the first scenario will die down in one year. Such transient activities drive the question: *Do we want these resources in-house or as contract labor? If so, how are these managed and validated for quality? Also, we need to evaluate if the organization can ramp up so many resources in each market.*
- In ESD deployments, the resource swings can be greater. This leads to newer resource strategies to avoid internal resources from conducting variable tasks. Also, this is where the COE concepts will come in very handy for increasing the efficiency of the internal resources.

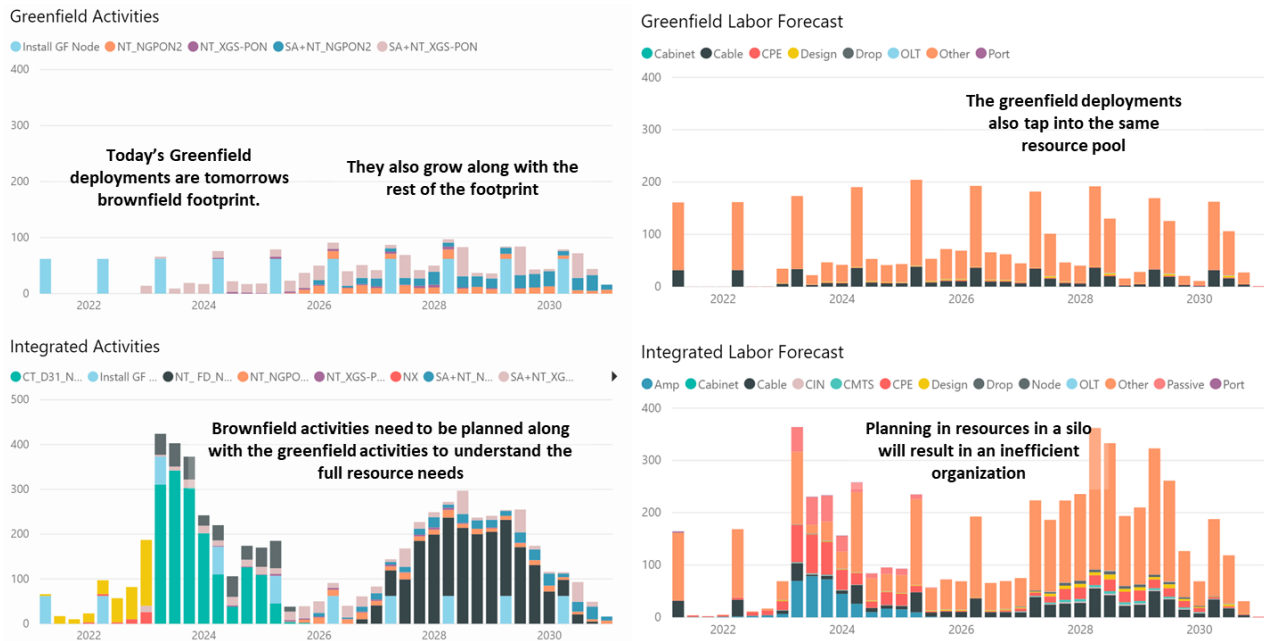
Based on these observations the operator should seriously consider the impacts of access transformation strategies on the in-house and contract labor management.

### 5.2.1. Integrated transformation planning

Cable operators are using FTTH as a technology of choice in their greenfield deployments. As shown in Figure 10, even a mere one percent of greenfield deployments can create a significant resource burden on the organization. Note that in our analysis we assume all the greenfield constructions are happening in the first quarter of the year. A common mistake many operators make is creation of a greenfield siloed organization. This often leads to overlooking future growth impacts of these greenfield deployments on the overall access organization. Also, as shown in Figure 10, addressing the operational needs of the brownfield and greenfield deployments separately leads to development of a suboptimal in-house organization and inefficient use of the contract labor.

These fragmented organizational issues will be further exacerbated with separate business organizations, wireless backhaul organizations (such as small cells etc.), and other overlay deployments. The key way to effectively use operators' most critical components of the access transformations – their people – is through integrated planning. As shown in Figure 10, the overall resource levels for each category can only be properly predicted by the integrated forecast of the activities and hence the labor resources.

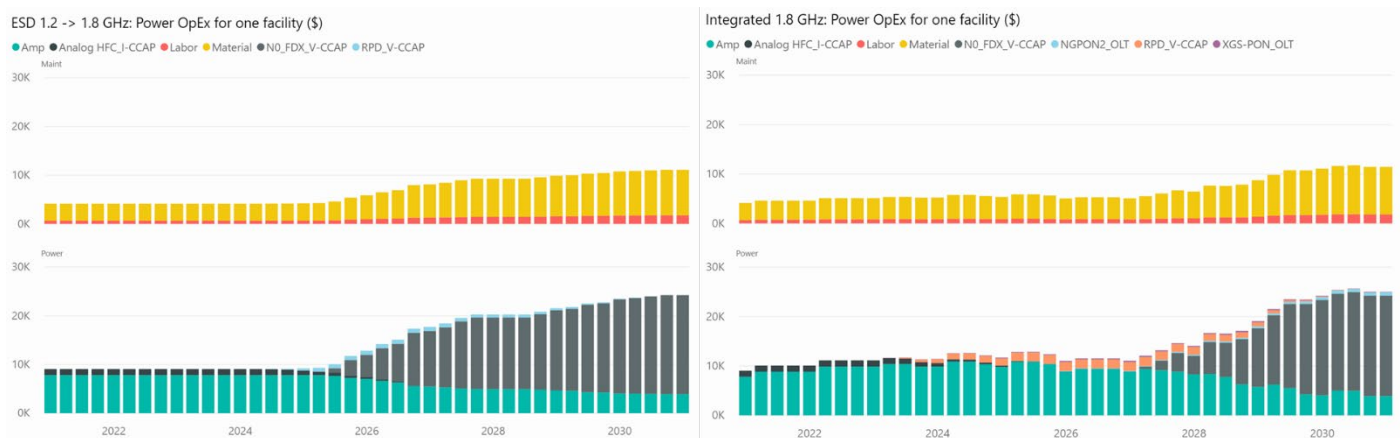




**Figure 10 - Integrated greenfield and brownfield planning is essential for efficient use of resources**

### 5.3. Powering operational impacts

Many downstream activities depend on access transformation strategies. One such important activity is the upgrade of networking powering infrastructure. As identified by the SCTE powering leadership [10],



**Figure 11 - Access power network options are directly dependent on the choice of transformations**

80% of the power consumed by the telecom operator networks is due to the access networks. We have shown in our previous works (in [11], [12], [13]) how the access transformation strategies impact the overall power consumption and hence the total cost of ownership (TCO). In Figure 11, we present two scenarios (only OSP powering is presented) in which the powering networks are impacted due to access transformations. The top graph dwells on the maintenance aspects of the power network and the bottom

graph on the power consumption aspects. Note that these forecasts are provided at a critical facility level. We advise operators not to optimize the powering solution at a node level, but at logical aggregation points such as facilities or markets. The following are some of the observations from these forecasts:

- The access power cost is only one component of the power network TCO. One also needs to consider the maintenance of the power networks.
- The effects of long-term strategies on the power consumption and TCO change from one transformation option to the other. For example, the fiber deep is going to drive the powering costs (due to increased N+0 nodes), as opposed to a longer amp (1.8 GHz) costs due to ESD options.
- Integrated planning is essential to get a clear view of the total consumption. There is no point in optimizing solutions for a single deployment when they become suboptimal for other overlaying deployments such as the greenfield, small cells etc.

The operational analysis on the access power network may not change the overall access strategy, but not considering the above observations, can create a suboptimal powering solution.

## 6. Recommendations

The execution capabilities of an access transformation plan depend on the material availability and efficient use of the labor resources. From the discussions in this paper, we make the following recommendations:

- **Operational evaluation should be the third pillar** of the access transformation analysis, along with architectural and financial analysis, before finalizing the plan.
- **Start with proper material and labor resource forecasting** due to the planned long-term strategic transformation activities.
- **Remember to perform integrated planning** (of greenfield, brownfield, overlay, business etc.), rather than siloed planning, to identify the true needs of the organization.
- Drive the operational efficiencies and meet the service level agreements through **relevant metrics** as proposed in this paper.
- **Keep the long term transformation vision in mind** while making the short-term material or organizational decisions.
- **Use different operational strategy options** presented in this paper **to de-risk the material and the labor programs.**

Reach out to the authors for further information on any of these topics.

## 7. Acknowledgments

All the models presented here are developed by access planning software, AP-Jibe, from First Principles Innovations ([www.fpinno.com](http://www.fpinno.com)).

## 8. Abbreviations

CIN	Converged Interconnect Network
COE	center of excellence
ESD	extended spectrum DOCSIS®
FD	Fiber deep
FTTH	fiber to the home
GA	general acceptance

ISP	inside plant
OSP	outside plant
SCTE	Society of Cable Telecommunications Engineers
SLAs	service level agreements
TCO	total cost of ownership

## 9. References

- [1] CableLabs, *10G platform*, <https://www.cablelabs.com/10g>
- [2] Sudheer Dharanikota, Luc Absillis, Mark Welsko, *Capital and operational spend aspects in Cable Operator 10G evolution*, September 2020, SCTE Energy Journal ([here](#))
- [3] Luc Absillis, *A multi-trigger what-if analysis approach to network transformation*, April 2020, FPI application note ([here](#))
- [4] Sudheer Dharanikota, *Understanding the basics of transformation in Telecom*, June 2017, DTS white paper ([here](#))
- [5] Luc Absillis, *How to reach 10G systematically?* August 2010, FPI application note ([here](#))
- [6] Luc Absillis, *Brownfield node upgrade strategy*, June 2019, FPI application note ([here](#))
- [7] Luc Absillis, *Access Transformation – Technology Basics*, November 2018, FPI white paper ([here](#))
- [8] Luc Absillis, *Solving the Access Network Footprint Expansion Enigma*, May 2019, FPI white paper ([here](#))
- [9] Rajesh Abbi, Luc Absillis, Sudheer Dharanikota, *Brownfield broadband access network planning in a rapidly changing environment*, April 2019, DTS white paper ([here](#))
- [10] SCTE, *Steering Into Cable’s Energy Future Takes All Hands on Deck*, ENERGY MANAGEMENT. SERVE. SOLVE. SAVE. ([here](#))
- [11] Rajesh Abbi, Sudheer Dharanikota, *Powering the future 10 G access networks*, September 2019, SCTE Energy Journal ([here](#))
- [12] Rajesh Abbi, Sudheer Dharanikota, Mike Glaser, Jessie McMurtry, *Powering the future 10G access networks - An End to End Perspective*, March 2020, SCTE Energy Journal ([here](#))
- [13] Rajesh Abbi, Sudheer Dharanikota, *Which powering solution is the best for my network upgrade?* February 2020, FPI application note ([here](#))

# **Adaptive Wi-Fi – The network optimization standard**

## **Shifting the Focus of Wireless Performance from Speed and Feeds to the Quality of the User Experience.**

A Technical Paper prepared for SCTE by

Adam Hotchkiss, Co-Founder, VP Product, Plume Design, Inc., SCTE Member  
290 California Ave #200  
Palo Alto, CA 94306  
adam@plume.com  
1-844-69-75863

Bill McFarland, Chief Technology Officer, Plume Design, Inc., SCTE Member  
290 California Ave #200  
Palo Alto, CA 94306  
bill@plume.com  
1-844-69-75863

## Table of Contents

Title	Page Number
Table of Contents	69
1. Introduction	70
2. Design Approach	71
2.1. Deconstructing the Home Router	71
2.2. The Advantages of a Distributed Wi-Fi System	73
2.2.1. Maximize Configuration	73
2.2.2. Multiple Pods, Any Number of Channels	73
2.2.3. MU-MIMO Technology is Limited	73
2.2.4. Leverage Software to Manage Complexity	74
2.3. What are the Pitfalls of Wi-Fi Repeaters or Mesh?	74
2.4. Network Capacity and Application Performance	75
2.5. A Cloud-Controlled Software-Defined Approach to Wi-Fi	75
2.6. Quality of the User Experience	76
3. Conclusion	76
4. Abbreviations and Definitions	76
4.1. Abbreviations	76
4.2. Definitions	77

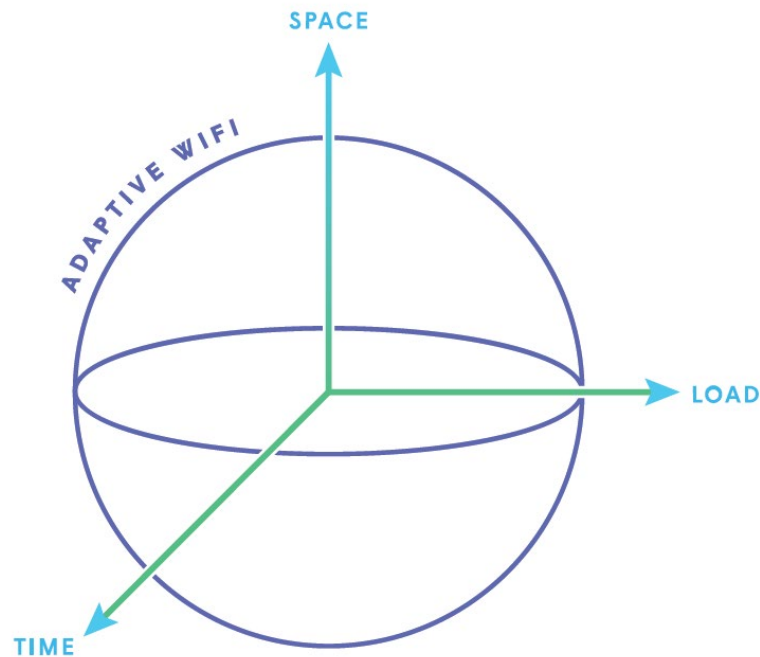
## List of Figures

Title	Page Number
Figure 1 - Adaptive Wi-Fi Dimensions	70
Figure 2 - Coverage Improvement with Single Wi-Fi Router HW Improvement	72
Figure 3 - Coverage Improvement With Distributed Wi-Fi System	72

## 1. Introduction

Today, in their homes, people are consuming ever more content, interacting via richer communications media, and relying on various internet-delivered applications and services to make their lives more comfortable and safer.

Led by the emergence of HD and UHD video-on-demand and IoT connected devices, consumers are using the corresponding applications and devices in even more places in the home, and Wi-Fi is becoming the standard way these devices and applications are connecting to the Internet. The broadband internet connection available in most homes today is extremely reliable and consistent with 99.9% uptime. Moreover, the upstream infrastructure and resources – compute, storage, CDN, DNS, and other cloud platform services – are even more reliable, with a 99.99% uptime. However, today’s consumer internet experience is often frustrating, with choppy video, dropped sessions, and inconsistent speeds. This problem is largely due to the Wi-Fi networks inside the home, the last few meters of the connection. Some of the key factors of this inconsistent performance are wireless interference, congestion, coverage impairments, and device (mis)behavior.



**Figure 1 - Adaptive Wi-Fi Dimensions**

Today, home Wi-Fi works well only in some places, some of the time. Current systems focus development and marketing efforts on performance in terms of single-application speeds and feeds; they don’t pay close attention to the requirements of a high-quality experience across many simultaneous applications through whole-home Wi-Fi coverage. Bringing a high-performing, consistent, and reliable Wi-Fi experience to every corner of the home requires a completely new architecture and delivery model, which is where adaptive Wi-Fi comes in. Adaptive Wi-Fi adds the space and time dimension to high-performance Wi-Fi, as illustrated in Figure 1, by replacing or complementing the centralized home router with a set of distributed, cloud-controlled, simple-to-install Wi-Fi nodes or pods. These small Wi-Fi access points are

placed at multiple locations around the house. In addition, adaptive Wi-Fi adapts the network over time, changing frequency channel allocations, backhaul link configurations and steering client devices to different APs as changing conditions and demands warrant. While traditional Wi-Fi is centralized and static, relying on local control, adaptive Wi-Fi is deeply distributed throughout the home and delivered as a cloud service that continuously adjusts to the needs of the home and its occupants.

Beyond the consumer, there are many others with a vested interest in high-performing, consistent Wi-Fi around the home:

- **OTT Service Providers**  
The over-the-top service provider (OTT-SP) ecosystem relies increasingly on consistent, high-performance Wi-Fi for adequate delivery of their content, customer satisfaction, and retention.
- **Communications Service Providers**  
As the “last few meters” of their broadband access infrastructure, communications service providers (CSPs) need managed, high-performance, and consistent home Wi-Fi for delivery of video-over-wireless, data, and other services to a multitude of wireless devices.
- **IoT and Smart Home Device Makers**  
The rapidly emerging IoT and smart home category requires adaptive Wi-Fi as a fundamental enabler to handle the growing number of connected devices consistently and reliably. The distributed nature of adaptive Wi-Fi ensures that the distance (range) between IoT devices and the home infrastructure is always short. Such an architecture is critical for IoT devices which are small and low-powered and cannot afford to transmit signals all the way across a home to a single access point (AP).

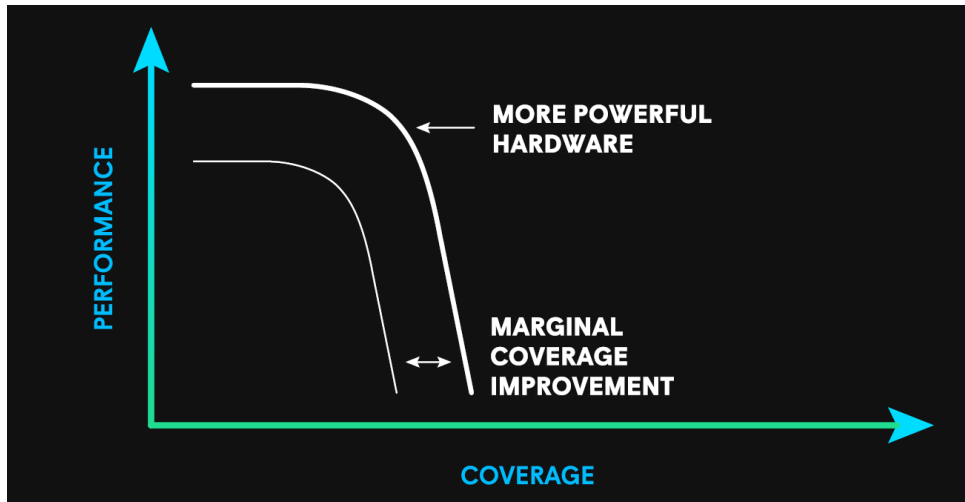
## 2. Design Approach

### 2.1. Deconstructing the Home Router

Wireless signals degrade with distance, more so when passing through walls made of common construction materials. This degradation is particularly severe if the walls are brick or stone (common in Europe), contain wire mesh (traditional plaster), or metal foil (common in insulation in newer homes). These building materials greatly attenuate Wi-Fi signals. The wireless signal corresponding to the Wi-Fi 11ac and 11ax standard degrades even more rapidly with distance since it uses the 5GHz spectrum as compared to the 2.4GHz spectrum used by earlier, slower versions of the standard.

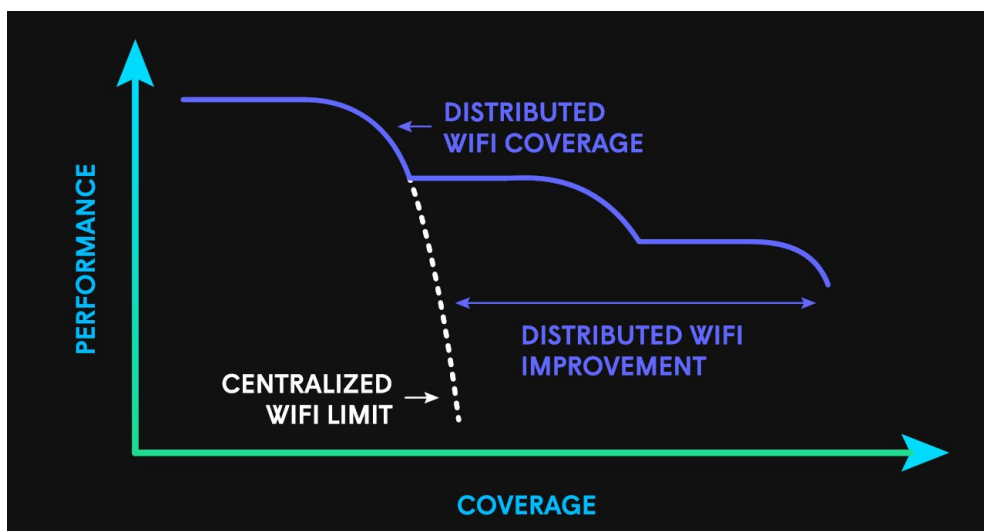
As the consumer is starting to use increasingly more bandwidth-hungry Wi-Fi devices at more and more places in the home, the approach taken by the high-end routers is to use increasingly more powerful hardware in the router in the hopes of driving the Wi-Fi signal to more places in the home. More powerful hardware means using more radio chains (antennas) with sophisticated signal processing (MIMO) and higher-power amplifiers to generate a stronger signal. This approach leads to higher cost, size, and consumption. In addition, very few devices are able to fully use the MIMO capabilities. In all cases, the increase in range that can be achieved this way is relatively incremental and reflects diminishing returns for larger increments in power and complexity. This can be seen theoretically in the path loss equation. In free space, the path loss goes up as the square of distance. However, homes are not a free space environment. Walls, furniture, mirrors, etc. increase the path loss with distance. Typical propagation models for in-home scenarios will have path loss increasing by the fourth power of distance or more. Doubling the transmitted power of the AP is already difficult. One approach would be to double the power of the RF power amplifiers. This will cause the AP to consume approximately twice the power, often creating thermal problems, and will require doubling the capability of typically four power amplifiers in state-of-the-art 4x4

MIMO APs. Another approach would be to double the number of transmit chains, from 4 to 8. However, this similarly doubles the power consumption of the AP, and will significantly increase the cost of the AP as well. Another problem is that current APs are sometimes up against the regulatory limit of transmit power depending on the frequency band they are operating in. Even if successful, all this effort yields less than a 20% increase in range in an environment with a path loss exponent of four.



**Figure 2 - Coverage Improvement with Single Wi-Fi Router HW Improvement**

Figure 2 shows the resulting improvement in coverage achieved by such higher-end routers. As distance increases, the rate of performance of the Wi-Fi signal is greatly diminished, and expensive increases in signal power and parallel transmissions provide only marginal Wi-Fi performance at distance.



**Figure 3 - Coverage Improvement With Distributed Wi-Fi System**

We can do a similar analysis on putting a Wi-Fi repeater or wireless extender midway between the transmitter and the receiver. If the repeater is placed at the edge of useful range of the first AP, and the



client device is similarly at the edge of range of the second AP, the distance supported between the first AP and the client device will have been doubled. This doubling of the range or coverage far exceeds the 20% improvement gained from doubling the power of a single AP. And this technique can be repeated any number of times. If three APs are added into the home, the overall range can be tripled; four APs can quadruple the range.

Figure 3 highlights more sophisticated distributed Wi-Fi approach, in which coverage is improved by sprinkling the smaller, lower power AP hardware (pods) across the home, so the data is conveyed from the gateway to the client through multiple hops.

With a sufficient number of APs (depending on the size of the home), the Wi-Fi signal never needs to travel very far between pods, or from the last pod to the final client device. By substantially shortening the distance that the Wi-Fi transmissions need to travel, this solution dramatically reduces the degradation of the Wi-Fi signal, allowing for substantially higher data rates throughout the entire home.

## **2.2. The Advantages of a Distributed Wi-Fi System**

With a single router, the Wi-Fi performance at different places in the home will vary based on the placement of the router since there is only one way for the signal to get from the router to a given device. In a distributed Wi-Fi system the APs can be connected by Ethernet cabling or more typically are connected using Wi-Fi wireless “backhaul” links; in both cases signals can take several paths to get to the client device, and therefore the system can be optimized to choose the most effective path.

### **2.2.1. Maximize Configuration**

Most Wi-Fi client devices (e.g., phones, PCs, TV boxes, IoT devices) use one or two antennas and do not benefit from the >4 radio chains built into the most powerful routers. A distributed Wi-Fi system can use a similar radio configuration as supported by the devices to avail a significant cost advantage without losing performance on the client connection speed.

### **2.2.2. Multiple Pods, Any Number of Channels**

A centralized Wi-Fi router can only use a limited number of channels, and those channels have to bear the load for all the clients on the home network. The multiple pods of a distributed Wi-Fi network can operate over any number of channels, thereby spreading the radio spectral load without causing interference. In a typical adaptive Wi-Fi home, a first AP (perhaps in the gateway) may present 5 GHz Wi-Fi channel 44 to client devices. It then may use a different channel, perhaps channel 157 to link to a second AP. That second AP can then offer Channel 60 to the clients that are near it. Assuming clients that are distributed across the home, half the clients will be connected on channel 44, and half on channel 60. This reduces the congestion seen by all devices in the home compared to all devices connecting on a single channel at the GW AP. This trend can be continued with the addition of a third, fourth, or even more APs in the home. The distributed network benefits from load balancing, allowing devices to be distributed among the multiple APs in the home, relieving congestion in the AP to client links.

### **2.2.3. MU-MIMO Technology is Limited**

Some of the recently launched 11ac wave2 and 11ax routers use MU-MIMO technology to allow a single router to send traffic to multiple client devices in parallel by using different subsets of its multiple radio chains. However, the resulting capacity increase is modest when operating in the same channel from the

same radio as compared to the significant capacity gain achieved from separating the multiple radios of a distributed Wi-Fi network in frequency and space. MU-MIMO gains are further limited by the fundamentally fragile nature of the nulling-based technology. For example, consider a 4x4 access point (four antennas that can be used simultaneously for transmit and receive, typically the highest performance MU-MIMO AP found in homes). When surrounded by 1x1 clients, the assumption is that the net throughput with MU-MIMO enabled vs. MU-MIMO disabled would be a factor of four, as the AP should be able to communicate with four clients simultaneously. However, Qualcomm’s measured over-the-air results, performed in optimal conditions, showed a capacity gain of only 73% compared to the “expected” 400% capacity gain. In fact, in that same test, Qualcomm found that sometimes the gain from MU-MIMO was only 38%.

#### **2.2.4. Leverage Software to Manage Complexity**

The proliferation of Wi-Fi nodes, or pods, throughout the home provides large degrees of freedom for traffic routing between the end device and the internet gateway connection. The number of potential connections between nodes is equal to  $N(N-1)/2$ , greatly increasing the ability to deliver a reliable, high-performance Wi-Fi service.

Distributed Wi-Fi networks are more complex to configure and manage, particularly if you are trying to configure them to achieve the optimum performance in each home considering the variety of conditions and layouts in which the network may be. This complexity is best handled with a centralized software entity with knowledge across the entire network. In essence, a distributed Wi-Fi approach achieves a superior wireless system by shifting the complexity from hardware to software.

### **2.3. What are the Pitfalls of Wi-Fi Repeaters or Mesh?**

Wi-Fi repeaters can be used to extend coverage in a way that may seem similar to the distributed Wi-Fi approach, but repeaters act as independent nodes and do not coordinate with the central router or other repeaters (nodes) in the system. Therefore, unintelligent repeaters cannot adapt to the changing needs of wireless networks and can only be used to boost (repeat) the signal from the central router. Some Wi-Fi repeaters repeat the signal on the same channel, thereby reducing the overall capacity of the network by occupying additional airtime on the one frequency channel. Even in the case where a repeater attempts to repeat the Wi-Fi signal onto a different frequency channel, it requires sophisticated management by the user to optimize performance. Any configuration created by the user will be a single static configuration, unresponsive to changing conditions or interference from neighboring networks. Moreover, in traditional repeater-enhanced Wi-Fi networks, the selection of the Wi-Fi node connected to each client device is completely controlled by the client device.

Client devices operating on their own will often not choose the path of maximum performance. For example, customers can experience extremely poor performance when their devices “stick” to a distant repeater rather than connecting to the nearby router. Finally, coordination of changes in the Wi-Fi network, such as channel or SSID changes, are hampered by the lack of a centralized authority. Typically, consumers changing their Wi-Fi network name or password end up in a tangle of reboots, disconnected devices, and partially connected networks. In sum, the use of Wi-Fi repeaters or extenders to increase range often leads to inconsistent results and often lessens the performance of the network as a whole.

A new class of Wi-Fi products forms a mesh network, coordinating with one another to increase the Wi-Fi range. Current mesh routing protocols are designed to provide reachability of traffic between mesh nodes, only ensuring that the traffic makes it to the internet gateway in some way. This focus of mesh routing on

the survivability of the backhaul traffic between mesh nodes largely ignores the routing demands of the connected devices. These unsophisticated routing protocols do not address application performance or wireless network capacity to achieve the desired customer quality of experience (QoE). In fact, most mesh systems available today operate on a single channel backbone thereby significantly limiting the overall capacity while being prone to self-generated interference. Additionally, the locally managed, traditionally distributed, control-plane mesh routing architecture increases the complexity of each individual node, making it difficult to increase capabilities by adding more nodes and routes to the mesh system.

## 2.4. Network Capacity and Application Performance

To address the wide range of potential Wi-Fi issues, an adaptive Wi-Fi system continuously responds to the environment and user behavior to optimize the overall network capacity and application performance.

Some of the differentiating aspects of an adaptive Wi-Fi system compared to repeater or mesh systems are:

- Continuous monitoring and avoidance of interference from neighboring networks.
- Leveraging multiple, non-interfering channels to operate the network routing paths thereby increasing capacity.
- Routing algorithms designed to balance the network load, maximize the network capacity, and optimize end-application performance based on client device requirements.
- Traffic shaping/prioritization for application-level performance.
- Ability to optimize network performance by steering clients to different pods in the system consistent with the optimized route topology.
- Fast client hand-off across nodes for application survivability and quality of experience.

## 2.5. A Cloud-Controlled Software-Defined Approach to Wi-Fi

Wi-Fi network controllers first emerged in the enterprise environment to handle coordination among multiple APs. Enterprise vendors have been steadily migrating towards virtualized controllers (controllers deployed as software in the cloud).

Leveraging a similar architecture to manage a distributed Wi-Fi home network offers several advantages:

- Centralized management simplifies coordination among distributed nodes and can more readily apply global optimizations across multiple customers. These optimizations can span large apartment complexes, or even entire regions of cities.
- Similar to channel frequency and bandwidth assignment, the assignment of client devices to pods (client steering) can be done more effectively with a centralized, global view of the network, including all client devices.
- Roll-out of new features and services is simpler, faster, cheaper, and less risky by updating the centralized cloud controller, without having to update the firmware on the in-home devices themselves.
- Network stability issues are eliminated with a centrally controlled network. Optimization is performed in the cloud, the result is configured in the network, and the network will remain in that state until the cloud decides to modify the configuration. This alleviates the problems experienced with distributed mesh systems in which each of the nodes are running independent algorithms and making localized decisions with arbitrary timing, thereby creating inconsistent and unpredictable network behavior.

- A cloud-based management system is able to aggregate data from many homes for analysis and learning. Improved methods for network optimization, client behaviors and bugs, and typical device/user patterns and behaviors can be extracted from such a cloud-based centralized database.
- The compute, storage, and memory complexity of each individual node is reduced, making the nodes smaller, less power-hungry and easier to develop and deploy. The cloud, with virtually unlimited compute power and memory, can run arbitrarily complex algorithms to learn and optimize.

## 2.6. Quality of the User Experience

End-user experience is the most important aspect of any adaptive Wi-Fi system design. Offering customers an easy and intuitive installation process including the onboarding of nodes, and network customization through iOS and Android apps is critical. In designing the system’s applications and flows, focus must be on consumer activity rather than packaging the system mechanisms. The adaptive Wi-Fi system will enable, for the first time in consumer Wi-Fi, customers to be in control of the performance of, and access to, their home Wi-Fi. Cloud-enabled features such as one-touch guest network access, remote performance monitoring and troubleshooting, IoT device auto onboarding, parental controls, advanced AI security, and whole-home motion awareness are features which can be continuously rolled out via the cloud platform over the life of the product without having to compromise due to legacy local controllers or hardware.

This shifts the focus of wireless performance from the prevalent speed and feeds paradigm to one focused on the quality of the user experience. As such, attention is paid to whether the consumer can get the internet performance he/she requires everywhere in the home. Cloud-controlled network optimization ensures continuous application performance, reliability, and coverage.

The combination of visibility and support is the third key attribute of a great consumer Wi-Fi system. The consumer is provided beneficial performance metrics, status indicators, and data insights for each client device—and the internet connection—with in-app troubleshooting to assist with inquiries when things are not working well. For example, “is it your internet, or is it your Wi-Fi?” Additionally, online or call support is provided by the CSP with the ability to visualize the customer network and related Wi-Fi and CSP KPIs from the cloud-fed operations center.

## 3. Conclusion

The unique capabilities of a distributed, dynamic Wi-Fi system with cloud-based control provides the best quality of customer experience when compared to other available Wi-Fi architectures.

The advantages can be seen in the network topologies themselves, including the use of multiple frequency channels in the backhaul, optimized selection of the number of hops, and channel frequency assignments planned across entire apartment complexes. It can also be seen in the management of the client devices in the networks, including simple onboarding, and coordinated client steering. Finally, the approach brings network management advantages including superior visibility and support, and the ability to easily upgrade and enhance capabilities, changing cloud software rather than code on an in-home device.

## 4. Abbreviations and Definitions

### 4.1. Abbreviations

802.11ac	current generation of Wi-Fi (Wi-Fi 5)
----------	---------------------------------------

802.11ax	next generation of Wi-Fi (Wi-Fi 6)
AP	access point
CDN	content distribution network
CSPs	communications service providers
DNS	domain name system
GHz	gigahertz
HD	high definition
Hz	hertz
IoT	internet of things
iOS	iPhone Operating System (Apple)
KPIs	key performance indicators
MIMO	multiple-input, multiple-output
MU-MIMO	multi-user, multiple-input, multiple-output
OFDMA	orthogonal frequency-division multiple access
OTT-SP	over-the-top service provider
QoE	quality of experience
SCTE	Society of Cable Telecommunications Engineers
SSID	service set identification
UHD	ultra high definition

#### 4.2. Definitions

Downstream	Information flowing from the hub to the user
Pods	Refers to Wi-Fi access points
Upstream	Information flowing from the user to the hub

# Aging in Place Business Case for Cable Operators

A Technical Paper prepared for SCTE•ISBE by

Dr. Sudheer Dharanikota, Managing Director, Duke Tech Solutions Inc.

[sudheer@duketechsolutions.com](mailto:sudheer@duketechsolutions.com)

+1-919-961-6175

Ayarah Dharanikota, Healthcare Strategy Consultant, Duke Tech Solutions Inc.

[ayarah.dharanikota@duketechsolutions.com](mailto:ayarah.dharanikota@duketechsolutions.com)

+1-919-376-5657

Dennis Edens, Senior Manager, Duke Tech Solutions Inc.

[dennis.edens@duketechsolutions.com](mailto:dennis.edens@duketechsolutions.com)

+1-919-332-9681

Bruce McLeod, Executive Director, Cox Communications,

[bruce.mcleod@cox.com](mailto:bruce.mcleod@cox.com)

+1-678-300-1700

## Table of Contents

Title	Page Number
Table of Contents	79
1. Document overview	80
2. Executive summary	80
3. Introduction	81
4. Market sizing	83
5. Business models	86
5.1. Telecom offerings for AIP	86
5.2. Operator market size	87
5.3. Potential business models	88
6. AIP business case analysis	89
6.1. AIP revenue forecast for operators	89
6.2. AIP solution cost projections	91
6.3. Profitability analysis	94
7. Conclusions and recommendations	94
8. References	95
Appendix A Emerging technologies to support an aging population	97

## List of Figures

Title	Page Number
Figure 1 - 2016 healthcare spend projection from National Health Expenditure	82
Figure 2 - Different stakeholders an operator can address with their AIP solutions	83
Figure 3 - 2020 AARP report forecasts that 53 million acted as caregivers to elders	84
Figure 4 - Projected AIP market size for different stakeholders	85
Figure 5 - Mapping aging population needs to offer which in turn mapped to the operator capabilities	86
Figure 6 - Telecom operators projected market size by the offers	88
Figure 7 - High level business models assumed in the revenue, cost and profitability analysis	89
Figure 8 - 10-year revenue forecast for different market segments	90
Figure 9 - 10-year revenue forecast by different offers	90
Figure 10 - High level estimated cost breakdown by AIP product offering	93
Figure 11 - AIP 10-year profitability forecast by offer	94

## 1. Document overview

### What is the problem?

How big is the aging in place opportunity for the cable operators? What are the financial considerations from revenue and cost points of view?

### Key Takeaways

We make the following recommendations to the operators:

- AIP opens the door for multiple stakeholders
- Profitability will reach 100s of billions of dollars
- Operators need to build inter-industry collaborations
- Their reward depends on the amount of risk the operators are willing to take

**Key words:** aging in place, AIP, telecom for healthcare, unified communications, IADL

## 2. Executive summary

The United States elder population (65+ years of age) is expected to double from 45M in 2017 to 95M by 2060. AARP reports that 90% of elders would like to age at home. This is in part due to comfort found in the familiar spaces and expenses saved by not paying for alternative care facilities. Hence the concept of aging in place (AIP) stems from wanting to stay in a familial space that is equipped with the needs to live there as long as possible. Each elder may require different levels of care as they age and as their health needs change. AIP is an opportunity for those individuals to receive their care at home with the help of others and burgeoning technology support.

AIP addresses not just the needs of the elders directly involved, but also their families, caregivers, providers, and payors. There is a large market of stakeholders who have a hand in what home life will look like for the elder. Since there are many types of players and stakeholders in the aging space, AIP has inherently become fragmented. We see companies solely focusing on caregiving, security, healthcare, etc. Cable operators have a chance to unify these solutions.

Many operators already have existing solutions (connectivity, video and audio, and smart device offering) and infrastructure that can be repurposed to fit the AIP needs. With these needs in mind, we have proposed four potential offerings they can offer while playing to their strengths:

- **Basic AIP:** A *Basic AIP* could offer services to help with some fundamental instrumental activities of daily living (IADL) and monitoring services. Refer to the “What are IADLs?” insert for a brief introduction to IADLs.
- **Hospital at Home (HAH):** A *HAH* could appear in many different ways, but overall, it would address the elder’s healthcare needs at home as opposed to visiting a hospital.
- **Install and Support (IandS):** The *IandS* is an overarching offering that can be unique to the stakeholder. For example, elders may have a lower need for IandS at home with simple-to-use devices, while hospitals may need a higher level of integration requiring more from IandS.
- **Other AIP Services:** *Other AIP services* include a wide array of potential offerings that are not covered by the other three. This could include sensor packages, analytics, cognition support, etc.

Each of these packages was created to take into consideration the needs of the elderly and how operators can enter the market. Many of these packages are flexible depending on the company and how they plan



to impact the AIP market. But when considering stakeholders and different offerings, our model predicted that in 2030 the operators could see \$155Bn in revenue. Some costs considered in this analysis include the customer premises equipment, service offering, operations, training, and overhead costs. Each offering will carry a different level of cost. HAH, for example, may require more technical medical training, thus incurring more training costs. Even after these costs are considered, we project US operators could generate around \$111Bn in profits in 2030.

### What are IADLs?

At a high-level, instrumental activities of daily living are broken up into seven categories [1]:

- Transportation
- Grocery/Shopping
- Housework
- Preparing Meals
- Finances
- Medication
- Outside Services

Each of these activities helps an individual live in a community independently. They are not, however, necessary for a functional life, but to improve the quality of life.

Cable operators have significant competitive advantages over traditional healthcare providers (or the hands-off support newcomers) due to cable’s customer relations, communication infrastructure, data hosting and analytical capabilities, installation servicing, and customer support services. Additional partnerships with AIP experts will allow operators to enter the AIP market quickly and introduce valuable solutions to the growing number of the elderly, as well as their families and caregivers, in the US. We would urge cable operators to move quickly to use these competitive advantages to capture market share while the market is still fragmented.

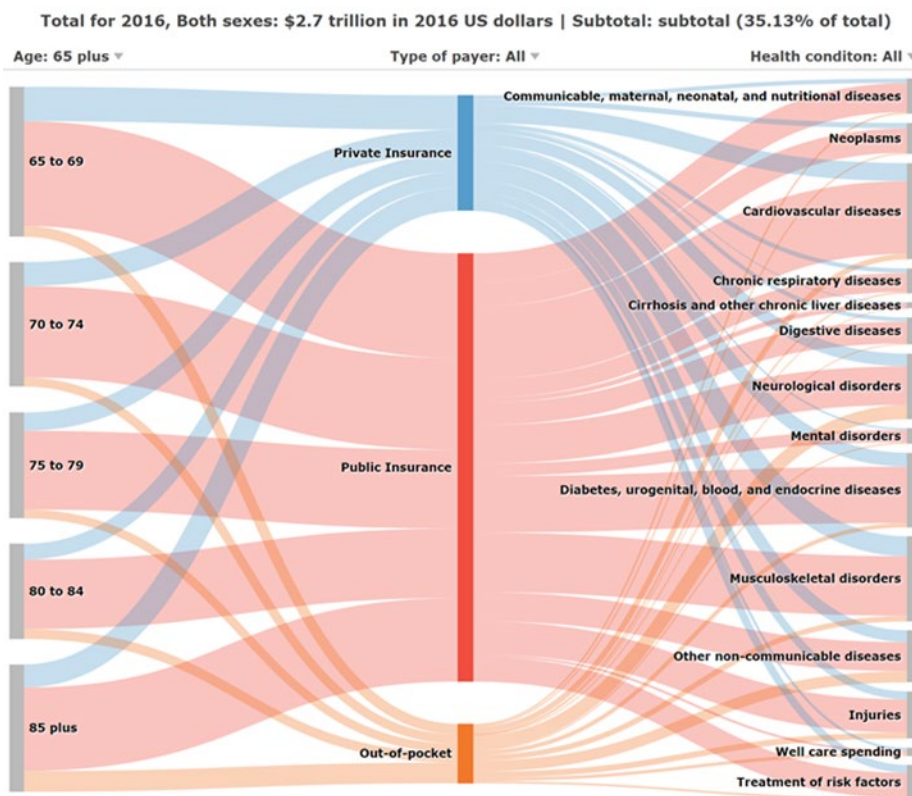
## 3. Introduction

With a growing aging population in the US, more elderly residents (65+ years of age) have started to look at aging in place (AIP) as an alternative to care homes. AIP is the idea of an elder being able to live in their own home with considerations of their safety, independence, comfort, and finally cost. As AIP has grown, it has touched multiple sectors: healthcare, communication and connectivity, transportation, mobility, independent living, and cognition to name the top few.

As COVID-19 comes to an end, many of us have seen the toll the pandemic has taken on all of us, especially our elder population. With the majority of COVID-related deaths affecting those older than 65, it has become more evident how susceptible this age group is to viruses or diseases. But countable deaths have not been the only way elders are affected. With an increased sense of isolation and lack of connection to others, it has taken a toll on seniors’ mental health [2].

Apart from the elderly and COVID, family and caregivers also feel the effects of the aging population. Family members, on top of taking care of their own immediate family, have to make sure their elderly family member is cared for. Many families spend their own money on elder care with no expectation of it being returned. Fear of strangers (3<sup>rd</sup> party caregivers) in their elder’s home is a prominent concern for families, specifically with fears of elder abuse [3].

Government has also invested a great deal into the welfare of seniors. In 2018, the government spent \$1.5 trillion on mandatory programs for the elderly: Social Security, Medicare, and Other Programs (Medicaid or TRICARE). They have also set aside housing grants that help certain individuals modify their homes. For example, qualifying disabled Veterans can get up to \$100,000 through a Specially Adapted Housing grant and \$20,000 from the Special Home Adaption grant. Qualifying single families can also receive a max \$20,000 loan or \$7,500 grant to help improve their home [4].



**Figure 1 - 2016 healthcare spend projection from National Health Expenditure**

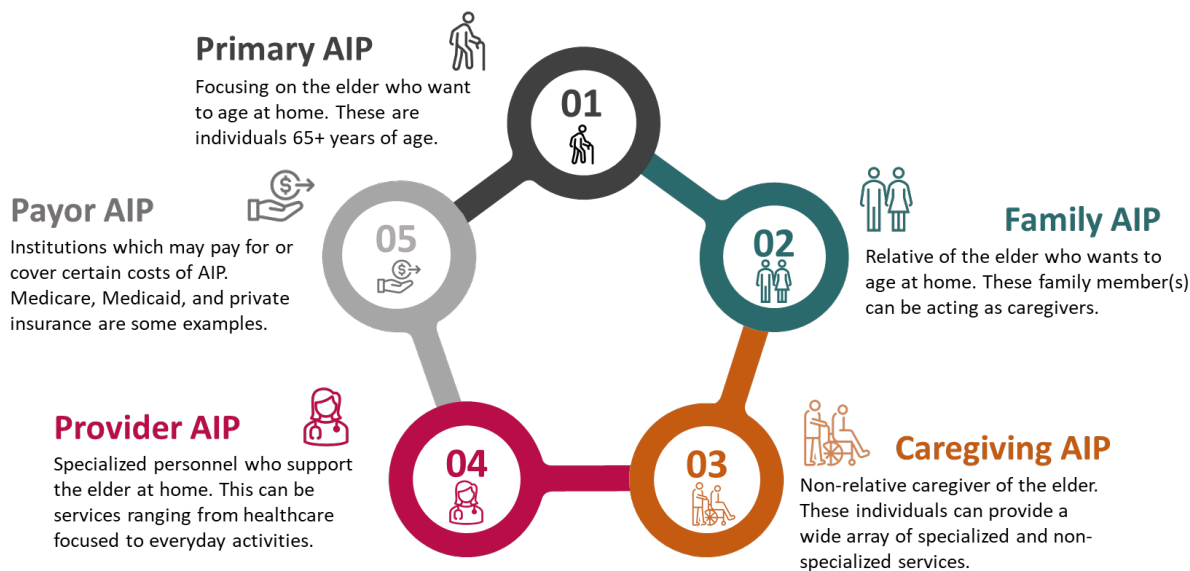
As shown in Figure 1, of the \$2.7 trillion government spending on healthcare in 2016, ~\$1 trillion (35%) was spent on people above 65 years of age [5]. Medicare also covers certain home health services such as physical therapy, part-time nursing care, medical social services, etc. However, there are certain daily activities (meal delivery, personal care, or house care) that Medicare does not pay; these need to be covered through personal funds [6].

Overall, of the AIP segments mentioned above, few AIP-directed government programs go beyond healthcare, financial assistance, or construction projects. This means the burden of payment lands on either the elderly or the family caregiver. With their established presence in the telecommunications industry, cable operators can build out services that unify their developed skills in – connectivity, communication, technology, and analytics. Refer to [7] for a detailed discussion on the operators’ differentiators in supporting AIP.

This paper will discuss different profitable offerings that operators can approach that extend on their current capabilities and provides tangible value to the various AIP stakeholders.

## 4. Market sizing

When trying to understand the AIP market we took a look at the key players: *the elderly, family caregivers, third party caregivers, providers, and payors*. Offerings for each of these players can be the potential market for the operators, as shown in Figure 2.



**Figure 2 - Different stakeholders an operator can address with their AIP solutions**

**Primary AIP:** With the elderly (65+ years), being the main target stakeholder for AIP solutions, we categorize them as primary AIP. Between 2017 and 2060 the 65+ population is expected to double from 45M to 95M [8]. As this population grows so does the healthcare spend for this market segment. Some of this healthcare spending can be addressed by the primary AIP through various means as discussed later in the paper. With a constant rise in average life expectancy, the age which is considered “old” has gone up to 65 years of age compared to in the 1920s when 55 was thought of as “old.” Additionally, in the US men and women tend to retire around 65 and 63 years of age, respectively. Reduced social security benefits can be received at 62 while full benefits used to be at 65 but these benefits are now a sliding scale (depending on when the individual was born). AARP has identified [9] that 90% of this 65+ age group is aiming to age at home as long as possible.

	2020 Prevalence	Estimated Number of U.S. Adults Who Are Caregivers	2015 Prevalence	Estimated Number of U.S. Adults Who Are Caregivers
<b>Overall</b>	21.3%*	53.0 million	18.2%	43.5 million
<b>Caregivers of recipients ages 0-17*</b>	5.7%*	14.1 million	4.3%	10.2 million
<b>Caregivers of recipients ages 18+</b>	19.2%	47.9 million	16.6%	39.8 million
<b>Caregivers of recipients ages 18-49</b>	2.5%*	6.1 million	2.3%	5.6 million
<b>Caregivers of recipients ages 50+</b>	16.8%	41.8 million	14.3%	34.2 million

\* Significantly higher than in 2015.

**Figure 3 - 2020 AARP report forecasts that 53 million acted as caregivers to elders**

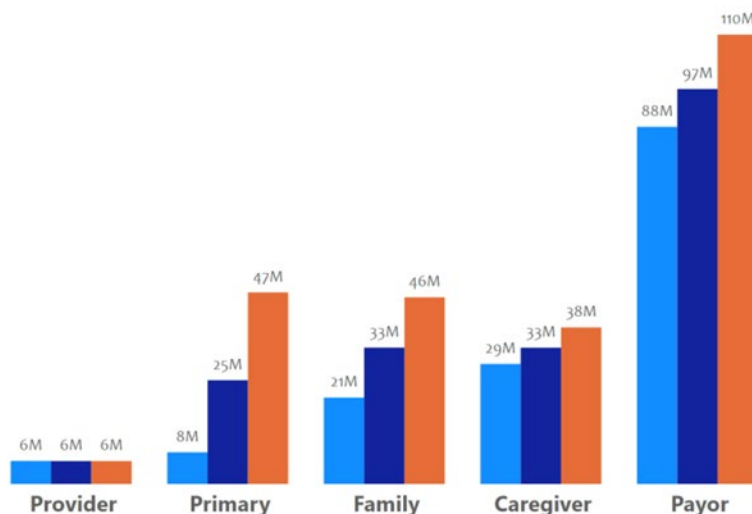
**Family AIP:** Family caregivers are also a large market to consider for AIP. In 2020, as shown in Figure 2, AARP [10] forecasted that family-based US caregivers (who acted like caregivers over the last 12 months) would be 21.3% (53M) of the US population. These caregivers spend, on average, 23.7 hours per week. 50% of those caregivers are children of the care recipient. This large market is necessary to consider since a large number of the elderly will need some level of support from a family caregiver.

**Caregiver AIP:** Professional caregivers who are not related to their elderly charges are considered in this category. Although AARP reports ~10% of caregivers are non-relatives, it is important to consider how these caregivers can support seniors. If a relative is far away or the caregiver needs respite care, non-relative caregivers provide a chance for specialized care. There are caregiving organizations that can provide everything from healthcare support to companionship. In general, caregivers (family or non-family) can help with services such as healthcare, cognition, mobility, ADLs, etc.

**Provider AIP:** The provider AIP includes both healthcare and non-healthcare providers. Providers here are specialized personnel providing some level of care to the elderly – such as healthcare providers, home health agencies (HHA), residential care communities, adult day service centers etc. Apart from caregivers, there are multiple types of individuals helping seniors age at home. We wanted to highlight the importance of managing one’s health by including healthcare providers and HHA. Healthcare providers can do everything from home visits to telehealth visits. HHA can provide skilled nursing services or therapeutic services [11]. Adult day services, similar to some caregiver services, can provide supervision, social activities, meals, and some medical services. To derive a market size for each of these providers, we took a percentage of the total number of home health agencies, nursing homes, adult day services, and residential care communities and separated it into healthcare/non-healthcare providers. In total, we estimate around 5.7 million agencies in 2021 providing care to the elderly. As we go through this paper, we will see how the portion of providers changes based on the potential telecom offerings.

**Market size forecast**

Year ● 2021 ● 2025 ● 2030



**Figure 4 - Projected AIP market size for different stakeholders**

**Payor AIP:** This category accounts for institutions such as Medicaid, Medicare, private insurance etc. While some seniors, or their families, may finance their own AIP journey, certain institutions will cover certain aspects of AIP. For example, Medicare can partially cover the cost of durable medical equipment or cover certain home health services. Each private insurance will act differently, but most will cover some level of health visits (virtual or in-person), home care services, etc. Medicaid will provide their level of health services and long-term care to the senior who has limited income or assets. The payor market reflects the size of the Medicare, Medicaid, and private insurance, as well as uninsured markets that have an interest in AIP. In 2021 we project that around 87.6M individuals would fall into one of the identified insurance categories. When we look at Figure 4, it shows that in both 2025 and 2030 payors still carry the largest market size. However, it is important to also note that while payor size is still the largest in 2030 their share of the AIP market decreases as the number of seniors, family caregivers, and third party caregivers grows.

Figure 4 provides an overall AIP market size over the next 10 years per market segment. In general, there is steady market growth in market size from 2021 to 2030. We forecast that primary AIP will see the largest year-over-year growth primarily because of the increase in the elderly population and those willing to age at home. With an increase in the number of seniors, there is also an increase in the need for family caregivers. Since family members are typically a large portion of caregivers, more family members are projected to be caregivers as the elder population increases. On the payor end, as AIP becomes more

commonplace, we predict there will be more coverage for AIP services.

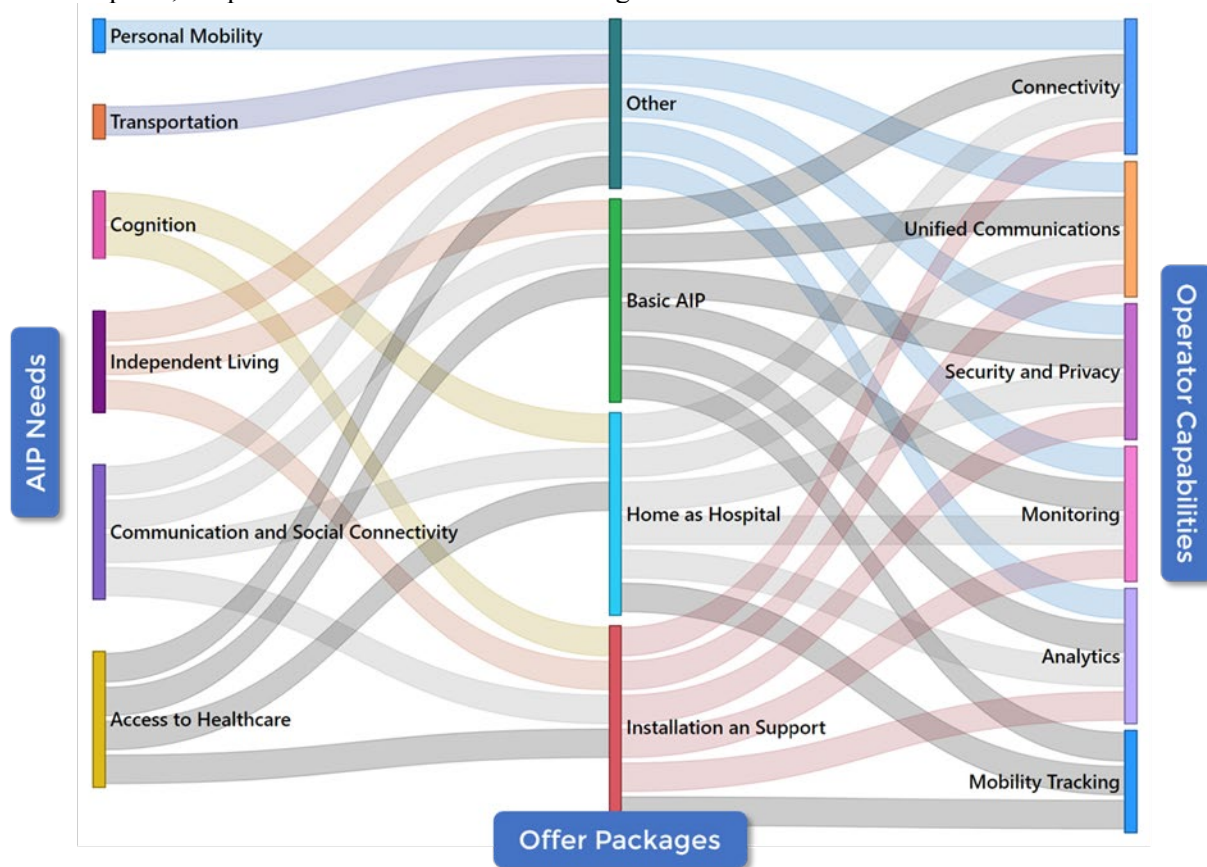


Figure 5 - Mapping aging population needs to offer which in turn mapped to the operator capabilities

## 5. Business models

### 5.1. Telecom offerings for AIP

Before devising different offers, we need to understand the requirements for the elderly. Since requirement analysis is not the main focus of this article, a summary of the needs conducted by a task force from the White House is presented in Appendix A, “Emerging Technologies to Support an Aging Population.” This provides six major categories of needs of the aging population. As shown in Figure 5, a service offering for the cable operators is the exercise of mapping the needs to the capabilities of the service provider. As presented in [7], the cable operator has significant technical capabilities that they are offering to their current broadband customers such as, connectivity, unified communication platforms, commitment to security and privacy on all their services, different in-home and network monitoring capabilities, burgeoning analytical capabilities, and different mobility-based services. In the figure, we show how to map the requirements to the capabilities through offers. These offers are that an operator can provide to address the problems are - basic AIP, home as a hospital (HAH), install and support (Iands), and other services.

**Basic AIP:** This basic offer, as shown in Figure 5, could address many of the needs of the elderly such as access to healthcare, communication and social connectivity (to reduce social isolation), and basic

cognition and more importantly enabling them to live independently. This offer would constitute the operator capabilities such as providing broadband and in-home connectivity, extending the unified communications that are offered to business customers to AIP stakeholders, guaranteeing the security and privacy offering (with which the operators are well versed) as part of the offering, extending their current service assurance infrastructure to the AIP offers, and providing metrics-driven basic analytics to the AIP offering.

**Home as a Hospital (HAH):** HAH takes the basic offer to the next level of complexity. This service, bringing hospital-level services to the senior’s home, would typically be driven by the cost, inconvenience, and risks (such as exposure to the diseases) of staying longer in the hospital [13]. While at home, the patient would ideally have access to a physician 24/7 and could receive at-home visits. Patients could also receive diagnostic tests such as EKGs, oxygen levels, echocardiograms, and treatments like oxygen therapy, IV fluids, antibiotics etc. However, these exams would be dependent on the devices available in the home. The main requirements that HAH could support would include access to healthcare, communication with the elderly individual’s support team (family, caregivers, and providers), and a higher level of cognition support. As shown in Figure 5, these could be offered through the cable operator’s current portfolio of services. The additional challenge they have to solve would be the integration of medical devices into their solution. Many business models could be adopted between the device manufacturers and the operators; these are not discussed in this paper.

**Installation and Service (IandS):** This would include any installation and support that AIP solutions would require. For example, an elderly person or their family member may want to install monitoring or security systems in the house to observe the senior’s behavioral changes in the home. Other examples could include health systems that can record falls, changes in sleep patterns, medication systems, etc. Depending on the devices or service there would be different levels of training and servicing required. Certain medical devices may need to be serviced or updated more often since they could directly impact the health of the elderly. This service could be offered as an upsell package by cable operators. As shown in Figure 5, the operator can support many of the requirements elders have in their daily life. These services would enhance the service offering that they are providing for their AIP portfolio.

**Other Enhanced Services:** These services would include a wide array of services that fall outside of instrumental activities of daily living such as sensors, management tools, analytical support, advanced cognition support, social isolation tools etc. These services might be ones that telecom operators may not have a direct influence in but could repurpose their offerings to fill in AIP needs. For example, transportation needs for the elderly could be fulfilled through an integrated communication platform by which operators can link the senior requesting the service with a local transportation company that is part of the operator’s ecosystem.

In the following sections, we provide the Telecom operator market size for the above product offerings, the revenue opportunities and the costs, and their profitability analysis.

## 5.2. Operator market size

With very conservative initial and growth assumptions per market segment (primary, family, caregiver, provider, and payor) and a detailed breakdown of these segments into subsegments for an accurate forecast, we derived this telecom operators AIP forecast for the next 10 years.

Telecom for AIP market size forecast

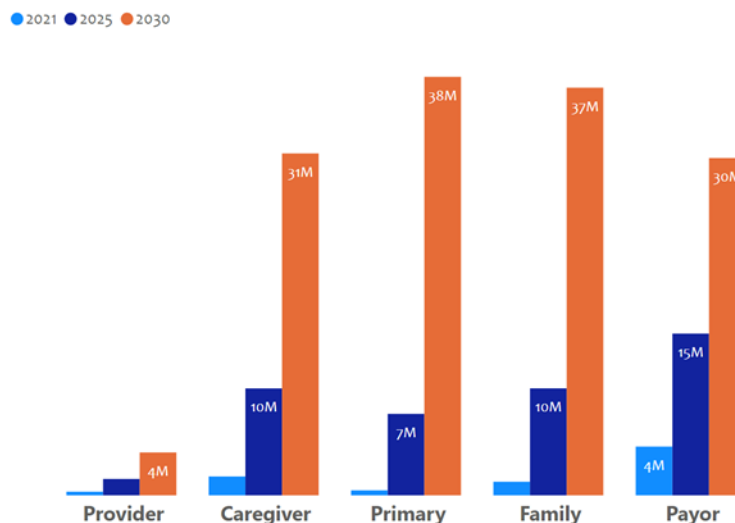


Figure 6 - Telecom operators projected market size by the offers

When looking at how the AIP market is projected to grow, as shown in Figure 6, it is clear that there is consistent growth in most segments. The market segment seeing the most growth is that of the primary stakeholder. We can attribute this amount of growth to the increasing rate of our aging population growth and increased desire to age in one’s own home. With this desire to age at home, there inherently comes a need for an increased level of service offerings.

Additionally, those individuals caring for the elder (family or caregivers) will increase as a result of the need for elders to have additional care. The growth in primary AIP will drive the growth in the HAH, IandS, and the other offerings.

### 5.3. Potential business models

Healthcare and care provider industries are mature industries. Entering into these markets requires a portfolio of strong differentiators and a mindset to collaborate with the incumbents. In Figure 7, we highlight the business models on how the operators can extend their capabilities in the four offers that were discussed in the previous sections.

*Basic AIP:* Since the basic AIP package deals with many of the strongholds of the operators such as communication and at-home activities, stakeholders such as the primary, family, and caregiver would directly be subscribing to the MSOs’ solutions. However, with healthcare and care services that are being offered on the MSOs’ platforms, there would be a need for operators to share revenue with providers.

*HAH:* For a HAH offering there may not be any direct revenue from the elderly, but instead through their healthcare provider. MSOs could work with providers to create services to fit the needs of the senior and take revenue share from those solutions. Through these solutions, operators could create services that family members or caregivers could opt into and thus receive direct revenue from those stakeholders.

*IandS:* Each stakeholder would require different levels of installation and support services. Primary, family, and caregivers might have some one-time installs with few support needs, while providers might need more services based on the level of care they provide. These would be direct revenue streams for operators.



*Other Offering:* The other offering encompasses some of the IADLs, advanced analytics, and additional, more-involved device integrations. Here we assume more complex use cases are addressed and metrics are monitored.

These revenue options are just a few of the possible ways MSOs can interact with certain AIP stakeholders. As operators grow their AIP presence, they can expand their business models on how they reach the stakeholders.

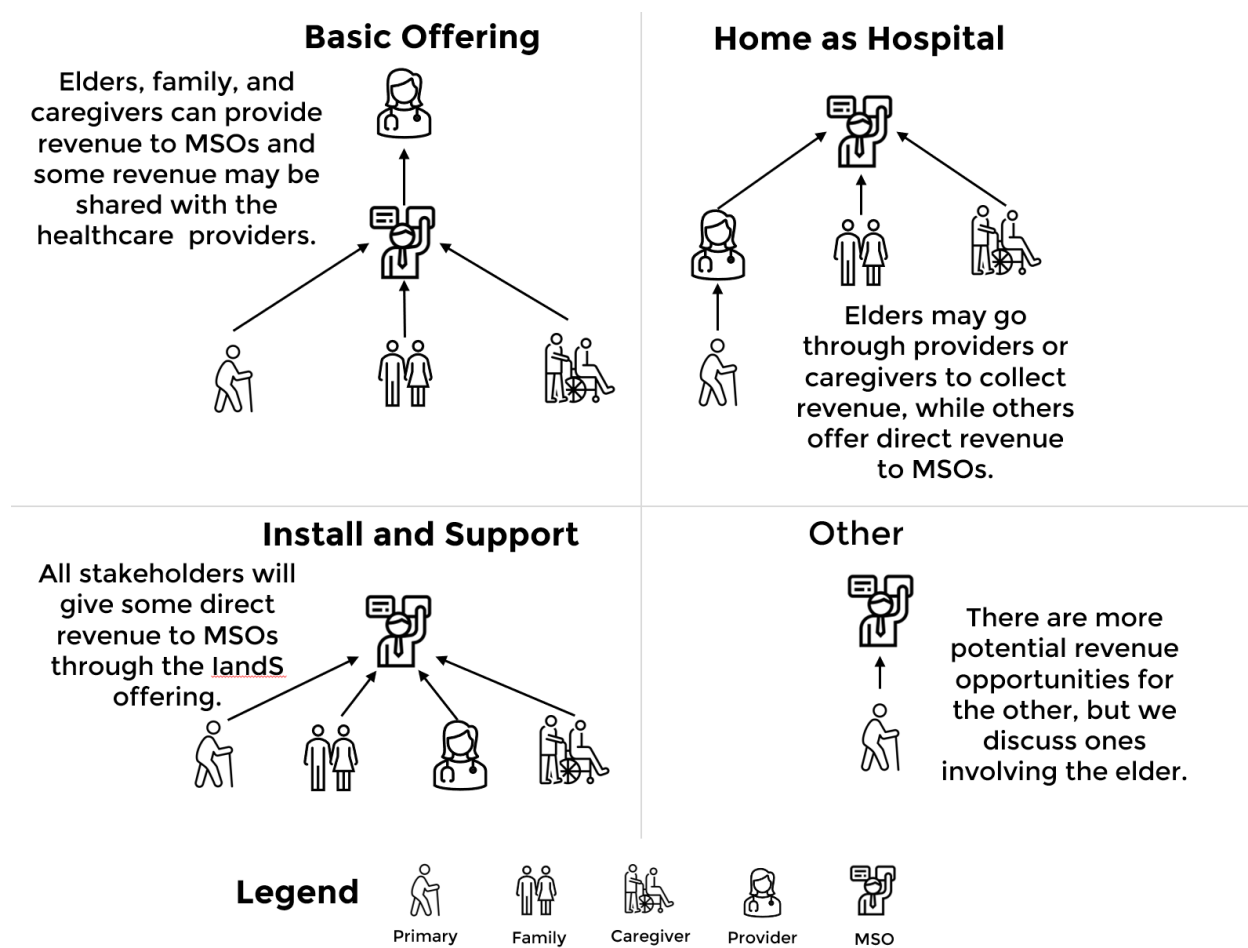


Figure 7 - High level business models assumed in the revenue, cost and profitability analysis

## 6. AIP business case analysis

### 6.1. AIP revenue forecast for operators

In this section, we provide some of the analyses in forecasting the operator’s AIP revenue opportunities. We have done extensive stakeholder business cases and analyzed business models used by different vendors to identify the operator revenue opportunities. The summary of this analysis is presented by market segments in Figure 8 and by offers in Figure 9.

Revenue opportunity by market segment

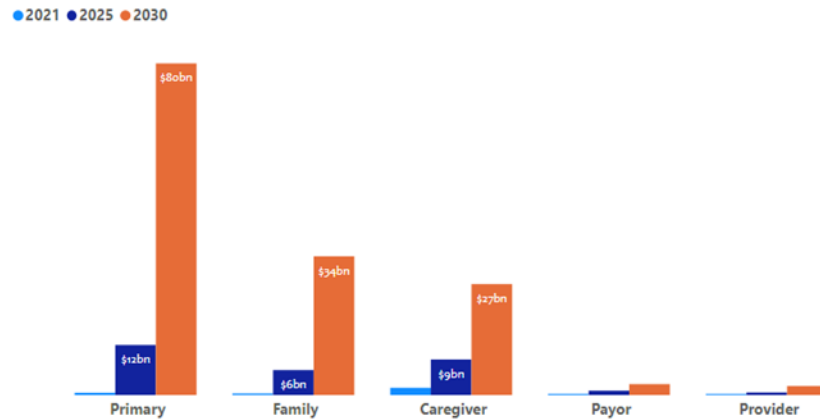


Figure 8 - 10-year revenue forecast for different market segments

*Basic AIP:* With the basic AIP offering, operators could derive revenue from the basic services that they can offer related to the enhanced unified communication services, video-capable devices, offering highly secure communications, smart medical devices rental, TV subscriptions for the interactive communications, and basic analytics to support some of the monitored data. For the primary AIP, operators would be between the elder and the caregiver (or provider). Hence, operators would collect the revenue from the elderly and their family, and distribute it to other parties in the value chain. In the same basic AIP realm, primary AIP, family AIP, caregiving AIP could all go through operators directly. The stakeholder’s business case would include for the elderly and their support team savings from the fuel, loss of wages and other family expenses that range up to \$150 per visit per family caregiver, as well as the overall reduction of cost up to \$75 per visit due to virtual nature of it. In addition, the operator could cross-sell those compatible video devices and AIP TV subscriptions that would be mainly attributed to the operator. Additional medical devices (such as pill dispensers from companies like Hero Medication, Tricella) could add additional revenue to the operators.

Revenue opportunity by offer

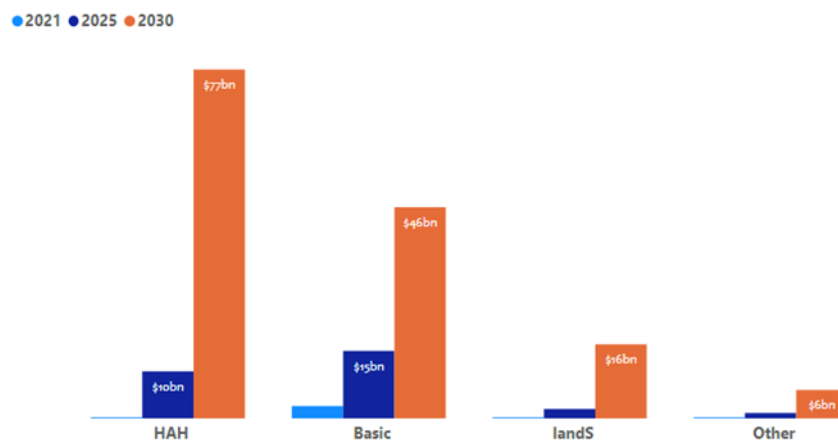


Figure 9 - 10-year revenue forecast by different offers

*Home as a Hospital:* Home as a hospital (HAH) saves on an order of \$2.5k per day to the patient compared to in-hospital patient care. In an HAH offering the operators could take revenue from cost

savings due to virtual visits, medical devices support, monthly rental etc. The patients in HAH typically would pay for Durable Medical Devices (DMDs) such as hospital beds or infusion pumps. Operators could integrate DMDs into their platforms and could take at least 50% revenue for monitoring services per month. In addition to monitoring, operators could take revenue from office visits and diagnostics. Many of these revenue opportunities for HAH can be found already in health concierge services. These services could potentially integrate with family or caregivers depending on the extent of the HAH model thus creating other revenue opportunities (such as monitoring, on-call medical alerts etc.).

*Install and Support (IandS):* In-home networking is complicated. Added to that the scare of handling healthcare devices takes technology paranoia to the next level. Who is suited to manage (install and service) these complex technologies better than the operators, who have been doing this forever? Adding AIP devices to their IandS portfolio would significant revenue in security, monitoring, health systems installation, and servicing. These installations could range from \$500 - \$1,000, and service charges could be as high as \$150 - \$300 per month.

*Other:* Since the other offerings capture a wide range of possible services, we only focused on a few services to project nominal revenues. One is the addition of more involved sensors in the home; different pricing models would be used depending on the function of the sensors.

*Revenue projection summary:* When comparing how these different stakeholders change with the identified offerings, it is apparent that there are some clear trends. In terms of relative revenue size, revenue from the primary stakeholder in 2030 is taking up a larger portion of the total revenue compared to 2025 (55% in 2030 vs 39% in 2025). Another point to note is the growth of the HAH offering with all stakeholders, especially primary AIP. One potential reason for this is the increasing availability, acceptance, and understanding of virtual health services. The pandemic did open many doors for virtual health services and that trend does not seem to be going away anytime soon.

## 6.2. AIP solution cost projections

End-to-end AIP costs are grouped into 5 main categories: *premises equipment, service offering, operations and support, training, and overhead.* For the cost model, each of these costs is further categorized into:

- Initial one-time costs: These are the costs of building the initial AIP infrastructure. This typically scales based on aggregation points and the scaling of the modular architecture per volume of customers (such as per thousand, per million customers, etc.)
- Net new customer costs: These are the cost of adding a new customer to the platform. This typically depends on the type of service to which a customer is subscribing.
- Per subscriber costs: These are per subscriber maintenance costs.
- Installation and support costs: These costs include per subscriber installation and support costs.
- Overhead costs: These are traditional management expenses such as marketing, sales, and organizational support, etc. These scale on the number of markets and the number of resources per manager.

Each of the cost categories will be reviewed in more detail in the following sections.

### Premises equipment costs:

Premises equipment is considered as any premises cost beyond the demarcation point at the customer's home. The demarcation point is defined as the AIP hub, which could be a logical or a physical device.

For any of the five market segments identified there will be a hub cost. The hub cost is expected to be different for each of the market segments. For primary and family needs the hubs and other relevant basic devices are assumed to cost between \$80 to \$100, and for other stakeholders between \$150 to \$200. Subscribers are assumed to either pay for their premises equipment or rent it for the time that they have the service. For this reason, no net new subscriber cost is applied for the premise equipment in the business case model.

The cost to support unified communications at the premises is projected to be the same on a per-user basis. Each user would have a licensing cost and be required to download a communication application. The cost of the associated application and license is expected to decrease significantly over time. These starting costs are expected (mainly due to revenue share models) to be less than \$10 per month.

Premises sensor costs would vary based on the offering, market segment, and the specific conditions to be addressed by the AIP solutions. Some of the sensor packages for the elders in the basic offering could be around \$750 while in the HAH case they could go as high as \$10K for purchasing (and \$1,300 per month for rental). Typical costs for the IandS could be up to \$300 per month. On top of this, an additional monitoring cost of up to \$10 per month might also occur per customer. Like the premises equipment, the sensor packages would also be purchased or leased by the customer. For this reason, no cost would be applied for the senior packages in the business case model. Equipment installation and maintenance costs would be covered under Operations and Support costs.

#### **Service offering costs:**

The most significant impact to operators in supporting the AIP market is expected to be felt in providing the services. Most of the changes will be one-time costs with some ongoing support and maintenance costs. Initial costs will be high as they are investing in the initial infrastructure, but these costs will come down over time significantly. Time to market is very important to obtain market share, so where justified, forming partnerships or outsourcing necessary service offering requirements is recommended. Below is a list of the primary service offering support requirements.

- Unified communications for individual households
- Personal or electronic health record (PHR or EMR) integration
- Platform compliance to Health Insurance Portability and Accountability Act (HIPAA)
- Security (not considered unique to the AIP offering) and privacy support
- Data hosting services
- Analytical services

Note that these service offering costs are expected to decrease over time as systems and processes are put in place to address the offerings.

#### **Operations and support costs:**

Operations and support costs are the costs to cover order fulfillment and customer service. These costs tend to have the biggest impact on the cost model. Because operators would be leveraging their existing order fulfillment and customer support organizations, they are projected to have a significant competitive advantage in the early stage of this developing market. They would also be better equipped to be more accurate at estimating and controlling these costs. In the operating costs, we have considered order fulfillment costs such as order entry and installation and customer services such as customer care and in-home service team costs.

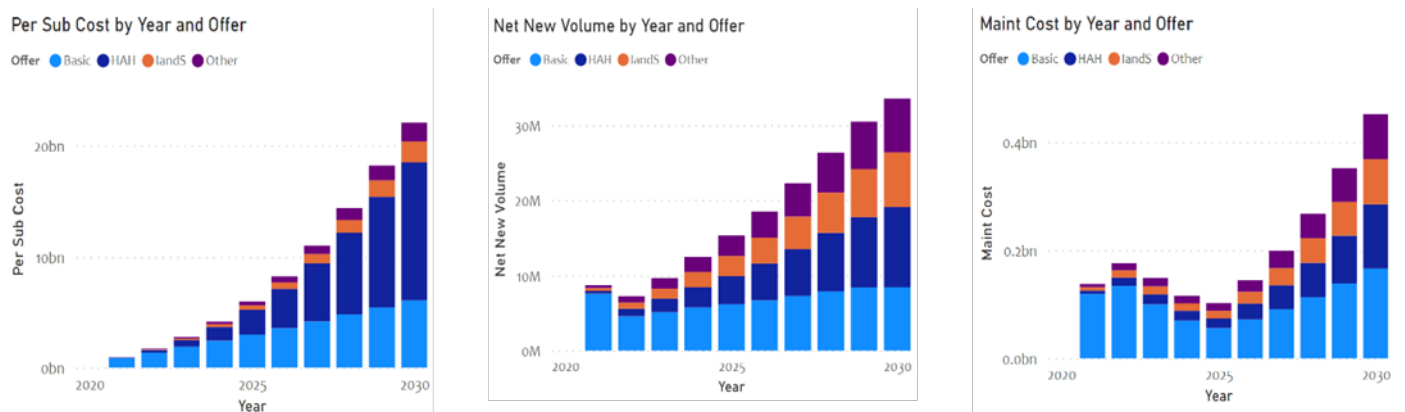
Employee training will be critical to achieve a fast and smooth introduction of AIP service offerings. Training is considered a one-time cost. However, additional training would need to be provided for onboarding new employees. Although the entire enterprise would need some form of training, primary training would be focused on five distinct areas of the organization.

- Installation and Provisioning
- Customer Care
- Field Service and Support
- Inter-industry sales and marketing support
- Other enterprise support

Training would include understanding the product offerings, which is key for all areas of the organization. Each organization will need to understand how these new offerings impact their job functions and any associated process changes that are made.

**Overhead costs:**

To cover the costs that are shared, an additional overhead charge has been assumed. These costs account for personnel responsible for the sales, marketing, and dedicated engineering personnel for the AIP solution support. An estimated headcount has been applied to the model. These overhead costs would be incurred year over year to support the product offerings.



**Figure 10 - High level estimated cost breakdown by AIP product offering**

**Summarized cost projections:**

As stated earlier, each of these cost categories is further classified for the AIP offers. Figure 10 shows a high-level estimation of the costs per sub, net new subscribers addition, and support.

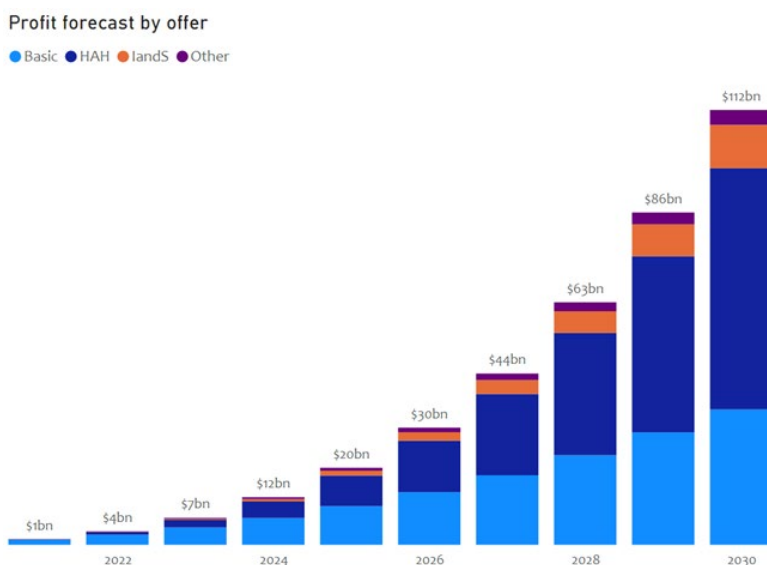


Figure 11 - AIP 10-year profitability forecast by offer

Per sub monthly costs would be the highest due to revenue share agreements with the other solution component providers such as unified communications platform, PHR or EMR services, and specialized analytical services. Maintenance would be the next major cost driver due to increased services. One can argue that ROI of landS is not high enough to offer these services. But because landS would be the key differentiator for the operators, they would drive higher revenues through gaining more customers for other services. Incremental cost for adding newer customers will diminish after the initial solution creation.

### 6.3. Profitability analysis

As shown in Figure 11, the AIP opportunity for operators is going to reach 100s of billions dollars in the US alone. We made a very conservative take rate assumption of 5% YOY growth in the market capture for operators. There is a significant upside to the profitability depending on the level of involvement an operator wants to have with the healthcare industry. We believe that as both industries learn to trust each other, they will take more risks of solving complex AIP problems and hence open doors for higher rewards than projected here.

## 7. Conclusions and recommendations

This paper outlined our research of the AIP market size and identified product offerings that are needed to fill the demand of a growing AIP market. The result of our analysis reveals a compelling opportunity for the operators to play a key role in fulfilling this market need by growing their product offerings and enabling end-to-end AIP solutions.

As this paper points out, the healthcare industry is looking for innovations to help control exploding costs and address changing market needs. The operators are uniquely positioned to help address this AIP market need. The cable operators have a competitive advantage in several key areas:

- Established relationships with target customer base
- Communication infrastructure ownership and control
- Data hosting and analytics capabilities

- Consolidated billing
- Service provisioning and management experience
- Customer service and support (boots on the ground) organizations in place

The key will be to use these competitive advantages to quickly capture market share and grow operating profits while the market is still fragmented. This market discontinuity is the optimum time to enter this expanding market.

To be most competitive, the operators will need to address their weaknesses in this inter-industry venture. Healthcare is a new area for MSOs with some unique challenges. You not only need to support patients (i.e., subscribers), but also the assortment of care providers and institutions. HIPAA regulations will also need to be addressed. From our market research and analysis, we were able to estimate the **telecom market size**, the **projected revenue**, and the **estimated cost** to support making these AIP offerings available. By modeling this data, we can calculate the projected profit. This model can be used by the operators and other operators in developing their AIP business case.

Based on our extensive analysis, we make the following recommendations to the cable operators:

- AIP gives a way for cable operators to enter the lucrative inter-industry collaboration with the healthcare industry. The cable industry is uniquely positioned with its current capabilities.
- Cable operators can develop partnerships with the caregivers, providers, and payors to integrate different stakeholders.
- AIP offerings are not just for the elderly but for the family, caregiver, provider, and payor communities.
- The development of integration partnerships and purchasing key technology will be crucial to bringing these offerings to the market quickly. The product offering strategy should focus on providing end-to-end AIP solutions.
- The offers presented here take into consideration of the level risk an operator is willing to take. We highly recommend exploring these during their internal strategic discussions.

AIP is not only a huge opportunity for operators, but it is becoming the new direction for aging in America. It gives the elderly, family, and caregivers a chance to take advantage of the fast-changing technology for some peace of mind and will be a change in behavior that continues for the foreseeable future. Refer to Duke Tech Solutions website at [14] to access an interactive model presented here.

## 8. References

- [1] Leslie Kernisan, *What are Activities of Daily Living & Instrumental Activities of Daily Activities*, article available [here](#)
- [2] W. Sepulveda-Loyola, *Impact of Social Isolation Due to COVID-19 on Health in Older People: Mental and Physical Effects and Recommendations*, paper available [here](#)
- [3] Tamara Stein. Working with Families: Building trust, article available [here](#).
- [4] USDA Rural Development, *Single Family Housing Repair Loans & Grants*, program information available [here](#)
- [5] *National Health Expenditure Forecasts*, available [here](#)
- [6] Medicare, *Home Health Services*, page found [here](#)
- [7] Ian Wheelock, Charles Cheevers, Sudheer Dharanikota, and Ayarah Dharanikota, *Cable Operators for Aging in Place – A Business Case*, paper available [here](#)
- [8] United States Census, *2017 National Projection Tables: Main Series Table 2*, data available [here](#)

- [9] National Conference of State Legislatures and AARP, *Aging in Place: A State Survey of Livability Policies and Practices*, paper available [here](#)
- [10] AARP, *Caregiving in the U.S.*, report found [here](#)
- [11] Centers for Medicare & Medicaid Services, *Home Health Providers*, page available [here](#)
- [12] Task Force on Research and Development for Technology to Support Aging Adults, *Emerging Technologies to Support and Aging Populations*, report available [here](#)
- [13] Duke Tech Solutions, *Telehealth Market Report – A Telecom Based Opportunity Analysis*, report available [here](#)
- [14] Duke Tech Solutions, *Aging in Place business case model*, available [here](#)



## Appendix A Emerging technologies to support an aging population

The report [12] identifies a range of emerging technologies that have significant potential to assist older adults, and it is offered as a guide for both public and private sector research and development (R&D) *to improve the quality of life, enhance individual choice, reduce caregiver stress, and cut healthcare costs.* The Whitehouse Task Force identified six primary functional capabilities as being critical to individuals who wish to maintain their independence as they age and for which technology may have a positive impact.

**1.Key Activities of Independent Living.** Living independently requires the ability to perform a range of activities that impact our daily lives. Many of these activities can be assisted through technology, including those that support good nutrition, hygiene, and medication management.

**2.Cognition.** Cognitive changes are common during aging, with increasing prevalence at older ages—varying in severity and impact. These changes can affect the ability to live independently as well as personal safety. Technology holds the promise to help older adults monitor changes in their cognition, provide mental training to reduce the impact of these changes, and create systems that assist individuals and families to maintain financial security.

**3.Communication and Social Connectivity.** Older adults may face communication challenges as the result of hearing loss, social isolation, and loneliness, especially in economically distressed and rural communities. Technology can improve hearing and strengthen connections to larger communities.

**4.Personal Mobility.** Mobility is a key factor in successful aging. To live independently, an individual must have the ability to move around the home comfortably and safely and throughout the larger community. Technology can assist older adults in staying mobile and able to safely perform key activities necessary for day-to-day life as well as interact with their communities.

**5.Transportation.** True independence requires mobility outside of the home and neighborhood. Transportation needs and limitations are dictated to an extent by the changes to individual physical and cognitive abilities that come with age. While some older adults remain completely independent and continue to drive without assistance, others may be able to drive but require vehicle modification and/or advanced technologies to assist them while operating a vehicle. New technologies could also help older adults more safely and easily use public transportation.

**6.Access to Healthcare.** Access to healthcare plays a critical role in helping older adults stay active and independent as they age. Activities and strategies that support the maintenance of function and independence with age are multifaceted. Alignment and coordination of these efforts through technology can increase the effectiveness and efficiency of these services.

In the process of identifying primary capabilities and focus areas on which technological advances can have a positive impact in enabling older adults to age in place, several areas emerged that are associated with a number of technological solutions and were therefore not specific to individual R&D recommendations.

# Aging in Place Market Landscape from a Cable Operators Perspective

A Technical Paper prepared for SCTE by

Dr. Sudheer Dharanikota, Managing Director, Duke Tech Solutions Inc., SCTE Member

[sudheer@duketechsolutions.com](mailto:sudheer@duketechsolutions.com)

+1-919-961-6175

Ayarah Dharanikota, Healthcare Strategy Consultant, Duke Tech Solutions Inc, SCTE Member

[ayarah.dharanikota@duketechsolutions.com](mailto:ayarah.dharanikota@duketechsolutions.com)

+1-919-376-5657

Dennis Edens, Senior Manager, Duke Tech Solutions Inc., SCTE Member

[dennis.edens@duketechsolutions.com](mailto:dennis.edens@duketechsolutions.com)

+1-919-332-9681

Bruce McLeod, Executive Director, Cox Communications, SCTE Member

[bruce.mcleod@cox.com](mailto:bruce.mcleod@cox.com)

+1-678-300-1700

# Table of Contents

<b>Title</b>	<b>Page Number</b>
Table of Contents	99
1. Document Overview	101
2. Introduction	101
3. Framework of Analysis	102
4. AIP Companies	103
4.1. U.S. Companies	103
4.1.1. AgingInPlace	103
4.1.2. Comfort Keepers	104
4.1.3. Elli Q	104
4.1.4. FirstLight Home Care	105
4.1.5. Greatcall	106
4.1.6. HeyHerbie!	107
4.1.7. Home Care Assistance	107
4.1.8. Home Instead Senior Care	108
4.1.9. Seniors Helping Seniors	108
4.1.10. TeleCalm	108
4.1.11. Tricella	109
4.1.12. TytoCare	110
4.1.13. Visiting Angels	112
4.1.14. Vayyar Home	112
4.2. International Companies	115
4.2.1. Domalys	115
4.2.2. FocusCura	115
4.2.3. Kraydel	117
4.2.4. SOFIHUB	117
5. Company Summary	118
6. Recommendations	120
7. Abbreviations	120
8. References	121

## List of Figures

<b>Title</b>	<b>Page Number</b>
Figure 1 - Categories of literature provided by AgingInPlace	103
Figure 2 – Specialized care provided by Comfort Keepers	104
Figure 3 - Elli Q Assistant	105
Figure 4 - Functions of the Elli Q Assistants	105
Figure 5 - FirstLight care services	106
Figure 6 - GreatCall's smartphone and flip phone	106
Figure 7 - Functions supported by HeyHerbie!	107
Figure 8 - Balanced Care Method created by Home Care Assistance	107
Figure 9 - Benefits of using TeleCalm	109
Figure 10 - TeleCalm device to reroute calls	109
Figure 11 - Tricella pillbox and corresponding app	110
Figure 12 TytoCare for professionals	111
Figure 13 - TytoCare devices	112
Figure 14 - Visiting Angel's Life Care Navigation provides personalized care	112
Figure 15 - What Vayyar Home sensors detect	113
Figure 16 - How businesses can use Vayyar Home	113
Figure 17 - Vayyar Home devices	114
Figure 19 - Domalys' products	115
Figure 19 - cAlarm service provided by FocusCura	116
Figure 20 - Kraydel interface	117
Figure 21 - Package and benefits for Konnect Device	117
Figure 22 - SOFIHUB home and beacon assisted living device and safety pendant	118
Figure 23 - Functionalities of SOFIHUB	118
Figure 24 - Breakdown of AIP companies based on White House Emerging Technologies categories	119

## 1. Document Overview

### What is the problem?

How can a cable operator address the aging in place (AIP) market space? Where are different AIP players, and how can service provider differentiate themselves?

### Key Takeaways

We make the following recommendations to the service provider:

- Develop end to end solutions
- Bring communication expertise to AIP
- Integrate different AIP related devices
- Extend their back-office solutions to AIP
- Create a marketplace for AIP caregivers
- Develop purpose driven analytics

**Key words:** aging in place, AIP, telecom for healthcare, unified communications, IADL

## 2. Introduction

By 2034, the *elderly* population (65+ years of age) in the United States will outnumber *children* (up to 18 years of age) [1]. In the US by 2060, the Census Bureau projects [1] that there will be 95 million people who are above 65 years of age. Additionally, the reduction in nuclear family size for this cohort implies that the population of family members available to serve as unpaid caregivers for the elderly is significantly going to be reduced compared to previous generations. Such changing demographics are creating significant stress on the healthcare system but are fostering inter-industry innovations. To counter healthcare costs, increase convenience, and increase independence the elderly is more and more preferring to stay longer at their primary residence. This concept of staying at home longer is commonly known as aging in place (AIP). AIP is strongly desired amongst seniors, but with a decreasing number of family caregivers, other options will be needed to address care. According to Forbes [2], the current AIP market for those over 50 years of age is \$7.1 trillion, which is 46% of the US economy. With the elderly population continuing to grow, Forbes projected that by the year 2032 the market will be \$13.5 trillion. The World Health Organization has also recognized that an environment that has cultivated support through “the built environment, people and their relationships, attitudes, and values, health and social policies” is key to healthy aging. For many people, this cultivated environment is their home.

A few benefits that come with AIP are maintaining independence, a familial environment, a healthy and safer environment, and lower cost. While staying at home, it is easy for the elderly to create a day-to-day routine that they can manage compared to if they were living in assisted living. This sense of control allows for an increased sense of independence. With a familial environment to lean on, elderly individuals have a place to look for comfort and security. They have created a space that is unique to themselves which may be difficult to achieve at a nursing home or an assisted living facility. It is also important to note that the elderly in nursing homes or assisted living facilities contracted COVID at higher rates and are faced more adverse symptoms because of both their age and potential underlying conditions. Some may prefer living in the comfort of their homes without fear of potential exposure. Lastly, in terms of cost, nursing homes or assisted living facilities can cost anywhere between \$10K to \$20K per year for a shared room and \$75K per year for a private room. Elderly individuals living at home can save thousands

of dollars in comparison. But to solve this complex problem of AIP, one needs to understand the requirements, integrate different relevant technologies, and manage these services for faster adoption. These topics are extensively discussed in [3][4].

With many converging industries playing into aging in place, companies have found niches to address. Some companies have decided to focus on caregiving services, cell phone plans for seniors, or even unique telehealth solutions for the home. None of them has addressed all of the needs of the AIP market, causing solutions to be highly fragmented and hence not completely adaptable. The following paper will look at 18 companies (US and International) whose mission is making living at home for seniors easier through the lens of their technology, service, and business models. We analyze and compare these companies with the goals of adoption using a framework developed in this paper. Finally, we make recommendations on where the cable operators should focus if they want to succeed in entering AIP services.

### 3. Framework of Analysis

Roughly 90% of the current elderly population [5] anticipates staying at home as they age. The service provider must understand how companies are addressing this growing group. We analyze the companies in this space from different technologies they use (against the needs), the services they offer (with the ease of adoption for the elderly in mind), and the business models they are using to generate revenue and integrate with partners. These three dimensions are explained briefly here.

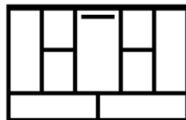
**Technology:** Companies offer different technologies based on their target services in six areas (independent living, cognition, communication and social connectivity, mobility, transportation, and healthcare access) as detailed in [6]. Even in their solution scope, they may focus on only a few technological areas, such as providing a basic app for educational purposes, monitoring solutions such as elderly mobility tracking, or highly integrated front- and back-end systems for end-to-end services. In addition, we analyzed how different AIP companies integrated technology into their services. For example, the company Visiting Angels has integrated Amazon’s Echo Dot™ into their service as a constant care companion. This Alexa device can also be used to call an urgent response agent.



**Service:** AIP companies can provide a wide array of both health and non-healthcare related services. Some common services caregiving companies provide are transportation services, housekeeping, meal preparation, hygiene care, Alzheimer’s care, or dementia care. Comfort Keepers is a good example of a caregiving company that integrates the services listed above and more. They have also partnered with Lyft to provide transportation services such as going to appointments. As we enter highly technical support into the six dimensions of the needs for the aging population, a successful services organization has to constantly find an optimized way to mix and match boots on the ground with technological innovations. Operators are quite familiar with such innovations from installation all the way to service support. When we analyze these companies, we will put on our operator’s hat to see how these companies fare in their service evolution capabilities.



**Business Model:** As we looked at each company’s business model, we were able to gather how they are integrating various partnerships (Lyft, Amazon, etc.), their screening processes, their value propositions, and their customer segment focus. For example, GreatCall is focusing on providing cellphones that are specifically targeted to seniors. They have the Jitterbug Smart2 (smartphone) and the Lively Flip (flip phone) which allows their customers to access urgent care, a personal operator, Alexa (only on Lively Flip), brain games, and more. With different approaches to the AIP market, many companies have been able to create unique value in this heavily-fragmented space. In our third dimension, we focus on how these companies fare with their business models from a sustainable AIP service point of view.



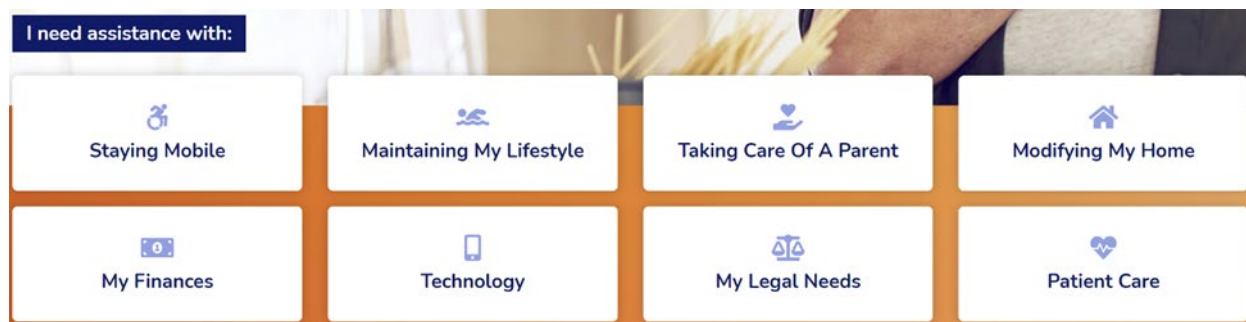
## 4. AIP Companies

The goal of this survey is to give a 360-degree perspective on the companies in the AIP market space, before making recommendations on what the service provider’s focus should or should not be. This company compilation looks at some of the companies from the purely services-based (such as Visiting Angels with boots on the ground) to those with AI-based robotic solutions (such as Elli.Q. The service provider should conduct such an analysis from their own AIP strategy perspective to evaluate where they have better opportunities and assess the best path for execution (such as partnerships, build-operate-transfer, or pure builds of the targeted solutions).

### 4.1. U.S. Companies

#### 4.1.1. AgingInPlace

AgingInPlace strives to help seniors, family, and caregivers plan for an AIP lifestyle. They provide relevant literature on staying mobile, lifestyle, home modification, in-home care, finances, technology, legal needs, patient care, and taking care of a parent. In addition, they compare different solutions available in the market. They rate certain services based on their reliability, equipment, features, services provided, technical support, transparency, word on the street, and cost.



**Figure 1 - Categories of literature provided by AgingInPlace**

*Company website:* <https://aginginplace.org/>

*Scope of their services:* Mobility, healthcare, and independent living. Providing informational services.

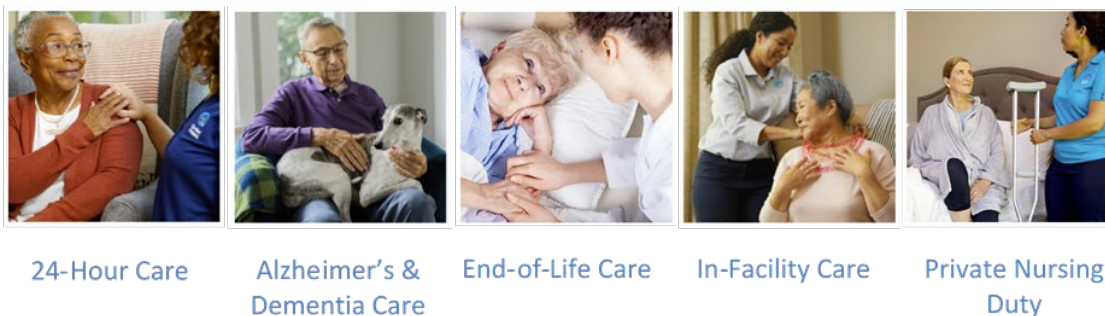
*Technology:* No technologies offered.

*Service:* Guiding the elderly through different instrumental activities of daily living, or IADLs (refer to Figure 1).

*Business model: (From their website)* “Our reviews are intended to guide you in choosing the best home care services for you and your family, and we use an established rating process that is free of bias or influence. To keep these services free, we do accept affiliate commissions from some of the companies mentioned on this site.”

#### 4.1.2. Comfort Keepers

Comfort Keepers’ philosophy is to provide high-level care to seniors through in-home caregiving. They have a variety of services including companion care, personal care, safety care, senior transportation (partner with Lyft), technology assistance, and interactive caregiving. On top of that, they provide specialized 24-Hour care, Alzheimer’s and dementia care, end-of-life care, in-facility care, post-hospital care, and private duty nursing (Figure 2).



**Figure 2 – Specialized care provided by Comfort Keepers**

*Company Website:* <https://www.comfortkeepers.com/>

*Scope of their services:* Transportation, healthcare, and independent living. Providing caregiving services to elders.

*Technology:* Personal emergency response system, medication safety and management, home monitoring system, and safety accessories.

*Service:* In-home care for seniors so they can remain independent at home. “Our services focus on physical needs and total wellbeing. We believe that everyone should experience the best of life, no matter their age or the level of care that is needed.”

*Business model: (From their website)* “Our uplifting in-home care services begin with an in-home visit. Our professionals complete a comprehensive assessment and develop a care plan that is customized for each client.”

#### 4.1.3. Elli Q

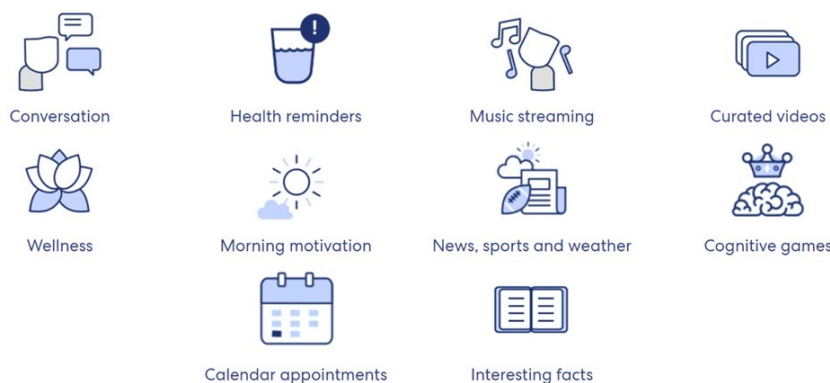
Elli Q is a tabletop intelligent assistant (Figure 3) was created to interact, connect, and engage elder users. As shown, it is claimed to do everything from conversing, play music, wellness, health reminders, etc.





**Figure 3 - Elli Q Assistant**

Elli Q is said to be able to tailor its system to the user. The system is designed to respond to a users’ voice, gaze, and touch. A user is provided the Elli Q body (moves with three degrees of freedom), base & charger (speaker, microphone, charging doc), and a screen. Figure 4 shows some of the features of the Elli Q.



**Figure 4 - Functions of the Elli Q Assistants**

*Company Website:* <https://elliq.com/>

*Scope of their services:* Cognition, communication and connectivity, healthcare, and independent living. Cognitive services mainly to avoid social isolation.

*Technology:* AI-based robot.

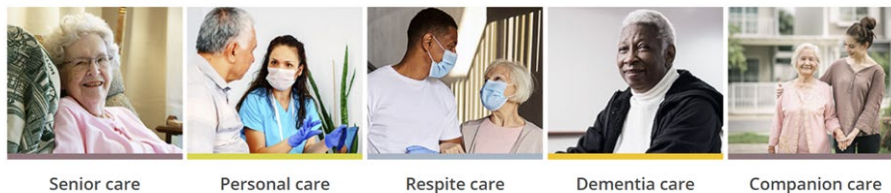
*Service:* Functionality seen above.

*Business model:* Hardware sales.

#### **4.1.4. FirstLight Home Care**

FirstLight Home Care provides non-medical in-home care (cooking, cleaning, laundry, bathing, etc.) for the elderly with various types of care services (as shown in the figure): senior care, personal care, companion care, respite care, specialized dementia care, and family caregiver support. Under their Brain Health Services, they offer memory care training that is certified by the National Council of Certified Dementia Practitioners. Some of their other programs under “improving brain health” are Ageless Grace (fitness), Constant Therapy (speech, language, and cognitive exercise app), Elite Cruises and Vacation (dementia-friendly cruises), and Nymbi (application to improve balance). Additionally, FirstLight Home Care provides travel companion services that offer in-person support to seniors throughout trips, whether it be checking in, luggage, security, and transportation. For the family, they provide client-caregiver matching, personalized care plans, client care access, consistent follow through, client feedback, and 24/7 availability. Some of the services are seen below in Figure 5.

## Let us keep your loved ones safe and well



**Figure 5 - FirstLight care services**

*Company Website:* (<https://www.firstlighthomecare.com/>)

*Scope of their services:* Cognition, healthcare, and independent living, as well as in-home care for elders, adults with disabilities, and busy families.

*Technology:* No technologies offered.

*Service:* Range of services to help elderly at home while also supporting the family.

*Business model:* Charging for services based on location, family needs, and customized rate plan.

### **4.1.5. Greatcall**

GreatCall provides older adults with mobile products so that they can live an independent life. They have two phones available: the Jitterbug Smart2 (smartphone) and the Lively Flip (flip phone) shown in Figure 6. With different packages, the phones can be compatible with GreatCall's health and safety services. In addition to cell phone services, they offer the users health and safety professionals linked to their mobile devices. A GreatCall Link app allows family caregivers to receive emergency alerts, check activities, retrieve location, and check on device status, and to access caregiving support resources.



**Figure 6 - GreatCall's smartphone and flip phone**

*Company Website:* <https://www.greatcall.com/>

*Scope of their services:* Communication and connectivity, independent living, cognition, transportation, mobility, and healthcare. Allowing the elderly to stay connected and safe through a combination of services with their cellphones.

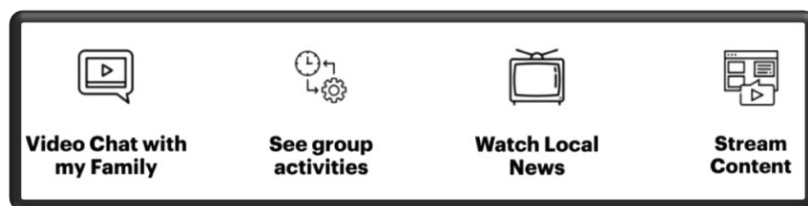
*Technology:* Smartphone, flip phone, medical alert device, the wearable urgent response device.

*Service:* Smartphones and external devices that connect to urgent care, have an app that keeps family up to date, and provide fall detection, partnership with Lyft, and brain games.

*Business model:* Initial charge for phone or device, then monthly charges depending on the package deal.

#### 4.1.6. HeyHerbie!

The goal of HeyHerbie! is to connect the elderly with their families, staff, group activities, streaming services, etc. through their HerbieTV™ Box. They have designed each element in consideration of the elderly population. Their install system simply requires a TV with HDMI capabilities, batteries, and broadband access. Currently, they are working with nursing homes, but the box is also compatible with home use.



**Figure 7 - Functions supported by HeyHerbie!**

*Company Website:* <https://www.heyherbie.com/>

*Scope of their services:* Communication and connectivity and independent living. Reduce social isolation through interactive services.

*Technology:* Hardware to connect to the TV and proprietary software.

*Service:* Connecting the elderly with their family or caregivers through seniors' existing TVs (services seen above in Figure 7).

*Business model:* Hardware sales and monthly services.

#### 4.1.7. Home Care Assistance

Home Care Assistance is a company that creates customized long-term care plans for seniors in their homes. They provide four different broad levels of care that can be tailored to each senior's needs: hourly, full-time, hospital to home, and specialized care. The caregivers help patients implement the recommended changes so that the transition is stress-free. The four steps they use to create this plan are: calling to determine needs, hiring caregivers that are matched to clients, assigning a full-time care team to assist remotely 24/7, and using the Balanced Care Method™ to train their caregivers (Figure 8).



**Figure 8 - Balanced Care Method created by Home Care Assistance**

The goal of this Balanced Care Method™ is to help reduce the negative effects of isolation and help seniors “live longer, happier, more balanced lives.”

*Company website:* <https://homecareassistance.com/>

*Scope of their services:* Mobility, cognition, transportation, healthcare, communication and connectivity, and independent living. Work to create personalized care plans for seniors at home, live-in caregivers, or those requiring special care.

*Technology:* No technologies offered.

*Service:* Provide elderly individuals and their families a wide variety of caregiving methods designed to suit the senior's needs.

*Business model:* Pricing depends on the care plan developed.

#### **4.1.8. Home Instead Senior Care**

Home Instead CAREGivers help provide individualized care to elders. They provide services such as personal care, hospice care, and respite care, as well as care for Alzheimer's, dementia, and other conditions. Home Instead does provide different websites for their locations that detail their various offerings. Not all locations offer the same set of services.

*Company Website:* <https://www.homeinstead.com/>

*Scope of their services:* Cognition, transportation, healthcare, communication and connectivity, and independent living. Using caregivers to help elders complete activities.

*Technology:* No technologies offered.

*Service:* Sending CAREGivers to help the elderly complete activities of daily living (ADLs).

*Business model:* Price of care depends on location, amount or type of care, personalized plans, etc.

#### **4.1.9. Seniors Helping Seniors**

Seniors Helping Seniors is a franchise that matches seniors with other seniors with the goal of helping both maintain independent lifestyles. The seniors can help around the house (companionship, light housekeeping, cooking, groceries, pet care, etc.), can provide assistance away from home (escort to appointments, errands, outings), and can support family caregivers (Dementia and Alzheimer's care, long-distance check-ins, respite care, overnight stays, and 24-hour care). In August 2020, [Seniors helping Seniors](#) announced their partnership with the company Electronic Caregiver™. Electronic Caregiver is a service that provides remote patient monitoring devices catered to seniors [7].

*Company Website:* <https://seniorshelpingseniors.com/>

*Scope of their services:* Cognition, transportation, healthcare, communication and connectivity, independent living. Matching elders with other older persons to help with small tasks.

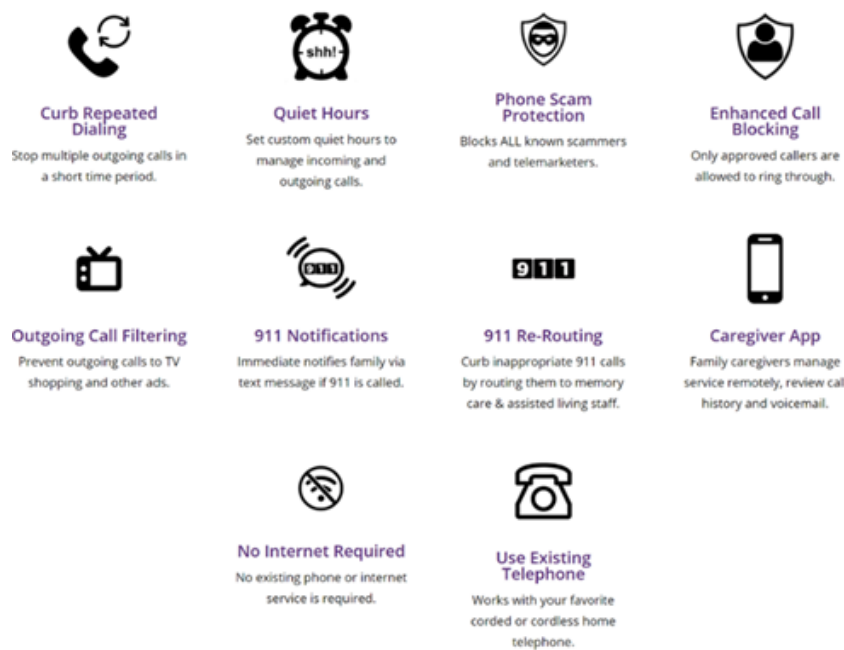
*Technology:* No technologies offered.

*Service:* Enable assistance with simple tasks such as housekeeping, cooking, errands, or specialized care.

*Business model:* Charge to recipient on an hourly basis.

#### **4.1.10. TeleCalm**

TeleCalm aims to protect seniors with memory problems when they use the phone. They help block scam calls, reroute inappropriate 911 calls to memory care, notify the family when 911 calls are made, connect family through the app, etc. (device seen in Figure 10). TeleCalm is also able to operate through an existing telephone system (Figure 9). They also provide users with different monthly plans.



**Figure 9 - Benefits of using TeleCalm**



**Figure 10 - TeleCalm device to reroute calls**

*Company Website:* <https://www.telecalmprotects.com/>

*Scope of their services:* Cognition, communication, and connectivity. Protect seniors from scam calls by connecting caregiving family.

*Technology:* Phone service management app.

*Service:* Manage call screening and provide controls to the family caregivers.

*Business model:* Monthly phone service (\$50 or \$40), installation fee (\$60).

#### **4.1.11. Tricella**

Tricella’s mission is to creating health and wellness products. Their team of engineers has created a digital pillbox equipped with sensors and an app that can alert the user and family members when pills have or have not been taken. The application connects to a smartphone through Bluetooth, which can push notifications. In-app text, call, and audio recordings track progress and history. The app can also

connect multiple pillboxes for patients who need to take pills multiple times a day. App and pillbox seen in Figure 11.



**Figure 11 - Tricella pillbox and corresponding app**

*Company Website:* <https://www.tricella.com/>

*Scope of their services:* Healthcare, communication, and connectivity. Medication management for the elderly, remote patient monitoring devices.

*Technology:* Medicine dispensing device, RPM devices, and management console for doctors.

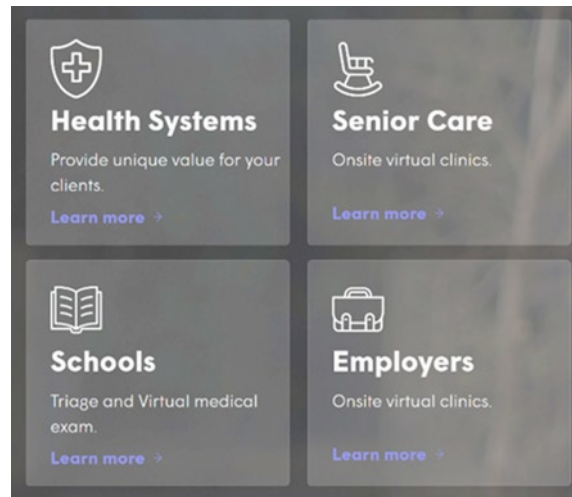
*Service:* Patient health and wellness products.

*Business model:* Sells pillbox and corresponding app for \$95.

#### **4.1.12. TytoCare**

TytoCare developed an FDA-cleared handheld exam kit (Figure 13), and app that allows the patient to perform certain exams from anywhere they choose. Their goal is to put the consumer's health into their own hands. The kit includes an exam camera and thermometer, otoscope adapter for ears, stethoscope for heart and lungs, tongue depressor adaptor for the throat, and the TytoApp for guided exams.

With the TytoCare kit, patients can conduct ear, lung, heart, throat, skin, temperature, and abdomen exams. TytoCare also connects the patient to a remote physician (ideally the patient's own physician or someone in the patient's physician network), who can examine results, diagnose conditions, and write a prescription (pricing in Figure 12). Tyto is diagnosing and treating more common conditions, such as ear infections, colds, flu, sore throat, etc. Tyto is currently only available for purchase through certain health systems and providers (Figure 12). They also require the patient to have a smartphone (last two versions of iOS or 4.4.4 and above for Android) or tablet and Wi-Fi. Within the program, they have built-in training videos; in addition, during live telehealth visits the provider will also guide the patient/user through the exam. They note that users can use a flexible spending account (FSA) to pay for the device and that exams/visits are often covered by insurance; however, this may not always be the case.



### Cost of a TytoCare visit

If your insurance covers telehealth visits, then it will cover a TytoCare visit. The copay should be the same for a visit with and without a TytoCare device. Due to COVID, almost all US insurance companies cover telemedicine and many are providing it for free. If it isn't free the co-pay is usually less than \$59.



**Figure 12 TytoCare for professionals**

*Company Website:* <https://www.tytocare.com/>

*Scope of their services:* Healthcare, communication, and connectivity. Integrated medical devices for healthcare checks with TytoCare doctor network.

*Technology:* Medical device integration, remote monitoring, conference calls, doctor workflows.

*Service:* Virtual doctor visits.

*Business model:* Per visit charges, device sales, monthly service charges, EMR integration. Doctor network integrated into TytoCare.

*Latest News:* TytoCare has partnered with [Fletcher Technical Community College](#) to provide students access to healthcare through their Virtual Wellness Center [8]. [Amwell](#) has also recently (early October 2020) partnered with TytoCare to resell the TytoCare kits [9].



**Figure 13 - TytoCare devices**

#### **4.1.13. Visiting Angels**

Visiting Angels performs in-home and elderly care services around the country. Visiting Angels also offers a free in-home assessment to determine what kind of care suits the client and matches them to a caregiver best suited for them. Under the Life Care Navigation (Figure 14) program, they have home care services, companion care, personal care, respite care, palliative care, social care program, ready-set-go home (avoiding hospital readmission), dementia care, Alzheimer's care, end-of-life care, and a Safe & Steady Fall Prevention program. The goal of the company is to meet the emotional, spiritual, and physical needs of the client to help restore hope.



**Figure 14 - Visiting Angel's Life Care Navigation provides personalized care**

*Company Website:* <https://www.visitingangels.com/>

*Scope of their services:* Mobility, cognition, transportation, healthcare, communication and connectivity, and independent living. Providing in-home personalized care so elders can live at home independently.

*Technology:* None specific to the company

*Service:* They provide care depending on the elder's needs (home care services to Alzheimer's care).

*Business model:* Cost changes based on location and type of care required.

#### **4.1.14. Vayyar Home**

Vayyar Home is a home monitoring solution that detects falls and calls for help when a fall does occur. When a fall does occur, the device connects the user to their caregiver or family member via mobile alerts and their app (Figure 15). The solution does not rely on cameras or visual data, but will be using sensors installed in the room, as shown in the Figure 17. The company also has opportunities for businesses to integrate their solutions (Figure 16).



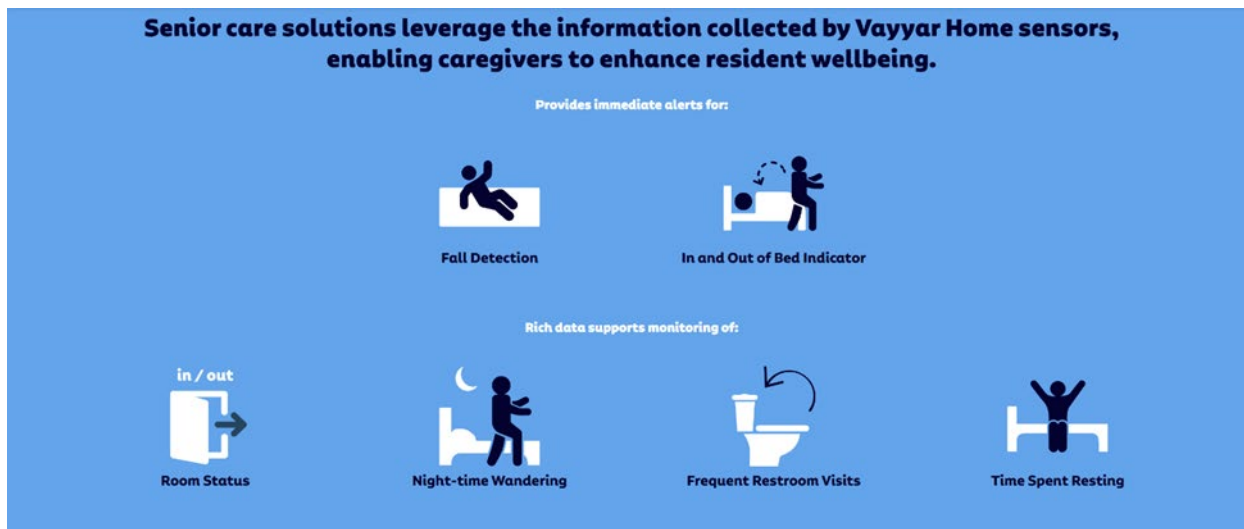
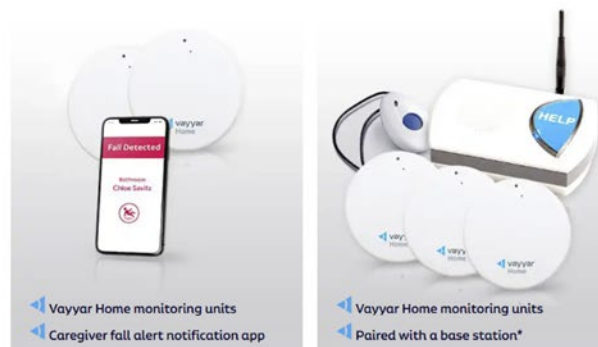
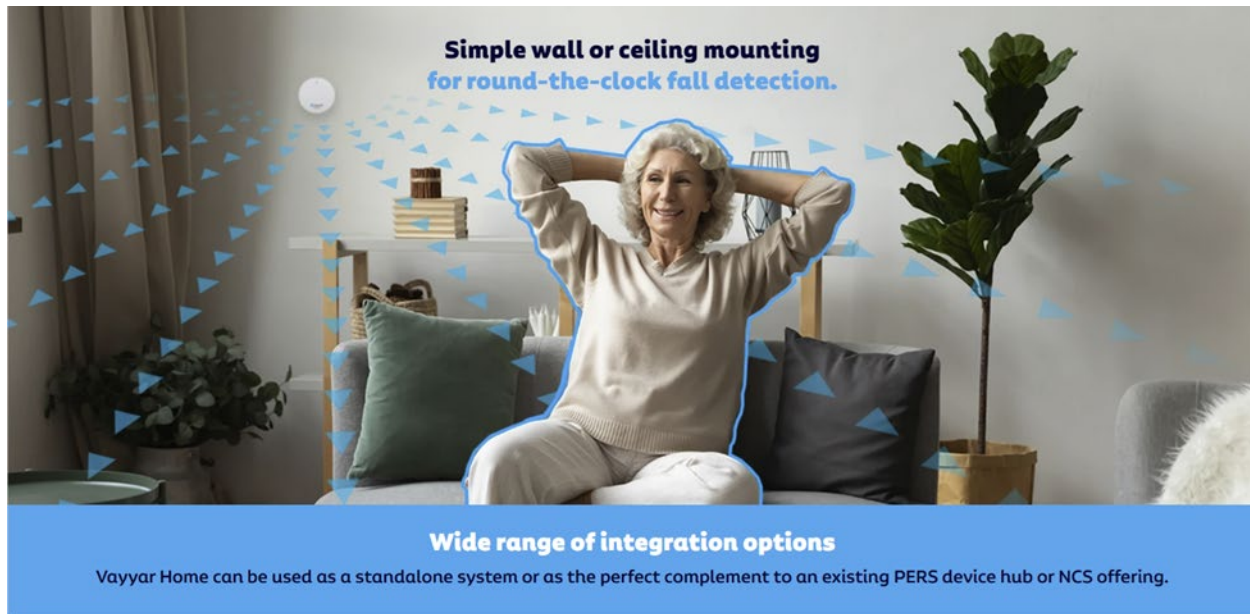


Figure 15 - What Vayyar Home sensors detect

**Scale Your Business with Vayyar Home**



Figure 16 - How businesses can use Vayyar Home



**Figure 17 - Vayyar Home devices**

*Company Website:* <https://vayyarhome.com/>

*Scope of their services:* Mobility, communication and connectivity, independent living.

*Technology:* Sensor devices, fall detection analytics, caregiver integration.

*Service:* Smart sensors around the house to monitor the safety of the elder (Figure 17).

*Business model:* Device sales and services.

## 4.2. International Companies

### 4.2.1. Domalys

Domalys is a French company that designs and creates products for our vulnerable community. The products include a smart lamp, tracking software, ergonomic tables, fun tables, armchairs, night-time safety assistants, hanging furniture, etc. (Figure 19). Their newest device is Aladin, a smart lamp created to detect early signs of illness and reduce falls. Beyond that, it can track sleep patterns that may be indicative of an underlying condition. The Aladin can be set up anywhere in the home and comes with a smart badge, team coaching, installation, and tech support.

*Company Website:* <https://www.domalys.com/en-US>

*Scope of their services:* Mobility, communication and connectivity, and independent living. Creating technology to improve individual care.

*Technology:* Wide array of products, listed on the right, to assist with a variety of care points.

*Service:* Each product works in service of a different need.

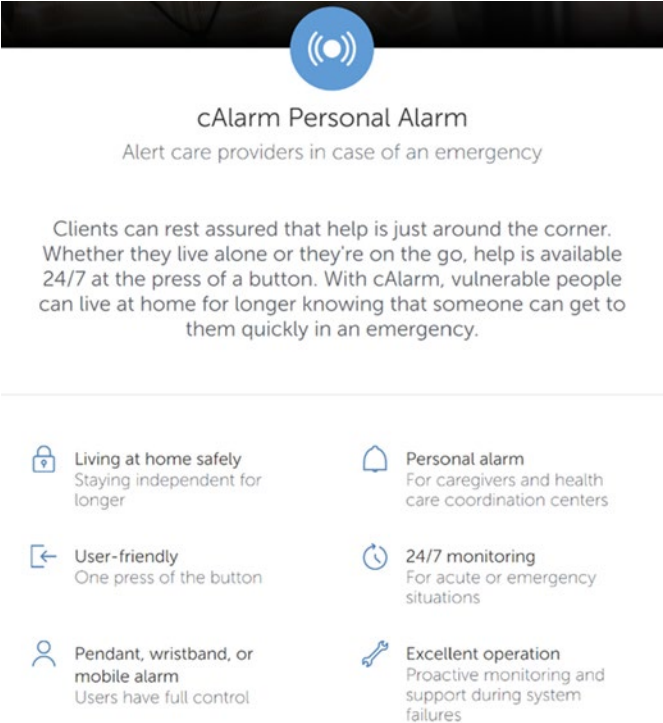
*Business model:* Services, furniture, and devices


### 4.2.2. FocusCura

FocusCura is a Dutch-owned company that focuses on virtual homecare and hospital at home to help the elderly stay independent in their own homes while keeping caregivers, family, doctors, etc. in the loop. They have developed three primary products to support their mission: cAlarm Personal Alarm, cKey Home Access, and cMed Medication Support. The cAlarm is available as a pendant, wristband, or mobile alarm. The alarm system can also connect to a patient's at-home sensors (Figure 19). cKey assures clients that home care workers and healthcare professionals can enter their homes when necessary. cMed assists clients with correct dosage and timing when they take their medication independently.



Figure 18 - Domalys' products











### cAlarm Personal Alarm

Alert care providers in case of an emergency

Clients can rest assured that help is just around the corner. Whether they live alone or they're on the go, help is available 24/7 at the press of a button. With cAlarm, vulnerable people can live at home for longer knowing that someone can get to them quickly in an emergency.

---

<p> <b>Living at home safely</b> Staying independent for longer</p> <p> <b>User-friendly</b> One press of the button</p> <p> <b>Pendant, wristband, or mobile alarm</b> Users have full control</p>	<p> <b>Personal alarm</b> For caregivers and health care coordination centers</p> <p> <b>24/7 monitoring</b> For acute or emergency situations</p> <p> <b>Excellent operation</b> Proactive monitoring and support during system failures</p>
--	--

**Figure 19 - cAlarm service provided by FocusCura**

*Company Website:* <https://www.focuscura.com/en>

*Scope of their services:* Independent living, communication and connectivity, and medication assistance.

*Technology:* Pendants, in-home devices, backend monitoring, caregiver integration.

*Service:* Device, installation, monitoring, and provider integration.

*Business model:* Device sales and charges for services.

### 4.2.3. Kraydel

Kraydel is an Irish company whose Konnect device enables video calling via the TV (Figure 20) for monitoring and interacting with the elders. It mounts its hub on the TV, connects via HDMI, and operates using a simple (yes or no options only) remote. The device is targeted at both the elderly and home care providers. Providers have access to a Konnect Dashboard that can send TV alerts and reminders (Figure 21).



Figure 20 - Kraydel interface

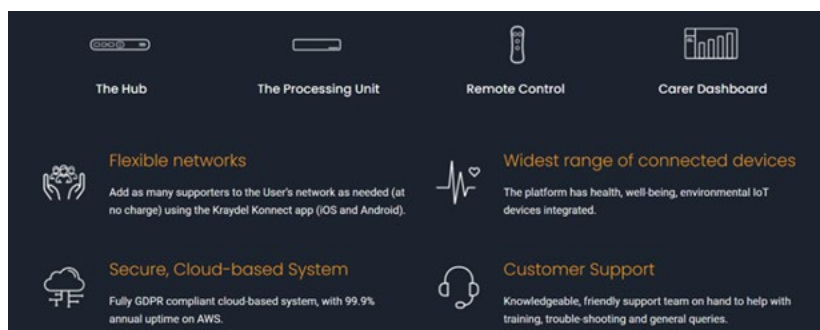


Figure 21 - Package and benefits for Konnect Device

*Company Website:* <https://www.kraydel.com/>

*Scope of their services:* Communication and connectivity and independent living.

*Technology:* Interact through a simple TV interface.

*Service:* Customer support over the phone.

*Business model:* Monthly subscription fee for individual customers and the care provider.

### 4.2.4. SOFIHUB

SOFIHUB home and beacon (Figure 22) are technologies created to help family members track their elder members while they remain independent at home. The SOFIHUB home is an assistant that provides alerts and spoken reminders, sends text-to-voice via an online portal, and tracks falls via in-home motion sensors. SOFIHUB beacon is a device that functions as a panic alarm, personal assistant, and fall detector. The users' location can be tracked through the online portal.



Figure 22 - SOFIHUB home and beacon assisted living device and safety pendant

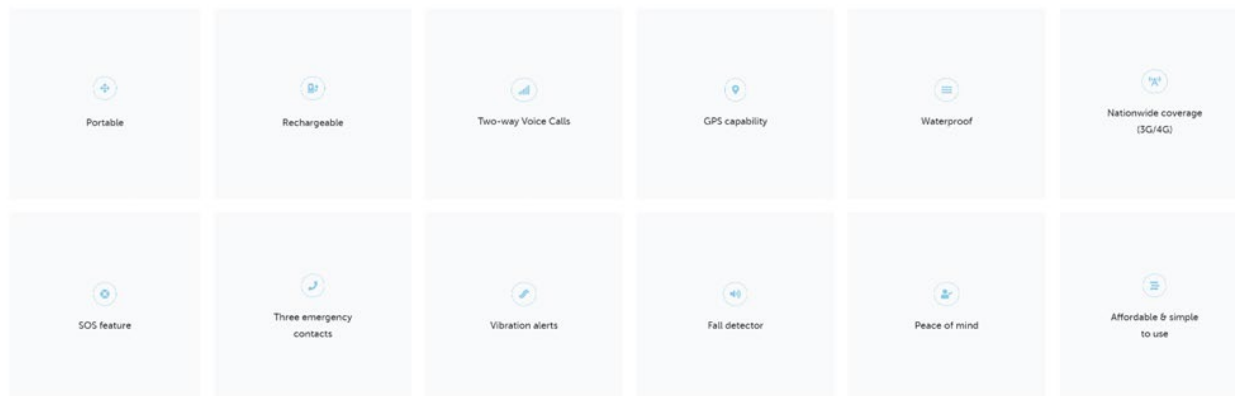


Figure 23 - Functionalities of SOFIHUB

Company Website: <https://www.sofihub.com/>

Scope of their services: Mobility and independent living.

Technology: Devices, two-way communication capabilities, manual fall detection.

Service: Portal, alerting, wireless integration (Figure 23).

Business model: Device sales and services.

## 5. Company Summary

In the figure below, we present the summary of how all the companies are addressing the six-dimensional needs of the aging population. These needs are the areas of interest identified by the White House in *Emerging Technologies to Support and Aging Populations* [6]. These companies are evaluated on the levels of solutions they are offering in five different capability dimensions. These capabilities are analyzed against:

- Caregiving: What emphasis is the company making in providing caregiving personnel? Is this online support or boots on the ground? Do they have trained personnel assisting the elderly?
- Device support: What innovations have they made in creating devices to assist the elderly in the areas where they claim their support?
- Back office support: Are they supporting the required back-office integration (such as telecom operators, EMR systems, caregiving networks, etc.) to offer a comprehensive solution?
- Analytical support: How strong are they with their analytical support for the problems the elderly is facing in the categories they claim as areas of expertise?
- Stakeholder Integration: Are they integrating the stakeholders such as the elderly, families, caregivers, providers, and payors into their solution?

Each cell in the matrix (Figure 24) represents the number of companies surveyed who we consider to be playing authentically in the given area. The areas where there is intense competition is highlighted in red, medium competition in yellow and lower competition in green. By looking at the market map, we can make the following observations:

- There are significant gaps in turning AIP offerings into solutions. For example, cognition, mobility, and transportation are glaringly underserved. Even the most popular themes of AIP such as healthcare and independent living are underserved in back office support and analytics.
- Independent living, connectivity, and avoidance of social isolation seem the targets for many AIP companies. There is a significant proliferation of front ends (devices) and back offices (portals) by these companies. This is leading to significant fragmentation.
- Healthcare is mainly focused on device support rather than creating a sustainable service by integrating different existing systems and relevant stakeholders.
- Analytics seems to be the biggest missing feature from all of the AIP companies' offerings.

	Caregiving	Devices	Backoffice Support	Analytics	Stakeholder Integration
Transportation	HCA VA AIP <b>3</b>	GC VH DOM <b>3</b>	GC CK VA <b>3</b>		GC <b>1</b>
Mobility	HCA FHC VA HISC SHS <b>5</b>	TC EQ GC <b>3</b>	VH <b>1</b>	VH DOM SOH <b>3</b>	FC GC SOH <b>3</b>
Cognition	HCA SHS VA CK HISC <b>5</b>	GC <b>1</b>			
Comm. & Connectivity	HCA CK VA FHC HISC AIP SHS <b>7</b>	TRI CK TYC GC FC EQ <b>6</b>	GC VH HH DOM TC FC TRI KRA TYC SOH <b>10</b>	EQ TC VH <b>3</b>	CK TYC TRI KRA FHC HCA VA SOH GC HISC DOM HH TC FC <b>14</b>
Healthcare	HCA VA HISC SHS <b>4</b>	FC KRA VH GC SOH DOM HH CK EQ TRI TC VA <b>12</b>	GC TYC <b>2</b>		GC KRA TYC SOH FC <b>5</b>
Independent Living	HCA CK VA FHC HISC AIP SHS <b>7</b>	FC VH CK GC DOM HH KRA EQ SOH <b>9</b>	VH DOM FC <b>3</b>	VH DOM <b>2</b>	CK KRA FHC SOH HH FC HISC DOM <b>8</b>

**Figure 24 - Breakdown of AIP companies based on White House Emerging Technologies categories**

## 6. Recommendations

Major innovations are happening in independent living, healthcare access, and connectivity services. Companies are focusing on their own devices and their platforms to integrate stakeholders. This is leading to very focused and fragmented solutions. In our opinion, none of these vendors (other than TytoCare to some extent) are focusing on valuable sustainable solutions.

Based on where the gaps are in the solutions, we recommend the following to the cable operators, who are entering into AIP market-fresh:

- **Follow an end-to-end solution approach:** Address solutions that are fragmented due to “*my solution on my platform*” syndrome with a fresh end-to-end solution approach. Cable operators are well versed with such solution delivery, which requires a scale of deployments, maintenance resources, and standardization.
- **Bring your communication expertise to solve AIP problems:** Social interactions are one of the main determinants of the success of AIP. Cable operators should repurpose their communication platforms to solve the needs of AIP.
- **Be a device integrator:** There are too many device manufacturers in play for every single healthcare, monitoring, and other elderly activity tracking needs. The cable operator should not work on device creation activities but rather should focus on certifying (or evaluating) different devices that can be deployed on their platform.
- **Extend your existing back-office systems for AIP solutions:** Extend your customer onboarding, management, service assurance, billing, and other platforms to support AIP solutions. This is a very valuable differentiator for the service provider. None of the smaller companies can replicate such capabilities.
- **Partner with the caregiving teams to complement your technical solutions:** Even though the service providers have boots on the ground for serving their customers, AIP-specific services are quite different from managing broadband services. We recommend the service provider create a platform through which the other more traditional AIP caregivers can participate.
- **Emphasize analytics from the beginning:** Develop purpose-driven analytics for maximizing the benefits of the technology-driven next-generation AIP solutions provided by service provider.

Aging in place is the next multi-trillion-dollar opportunity for cable operator. They are in the right place to make this inter-industry venture a win-win for both industries. In our opinion, the cable industry is well equipped to deliver AIP solutions that include a plethora of highly technical solutions they create and manage in their day-to-day activities.

## 7. Abbreviations

ADL	activities of daily living
AIP	aging in place
AI	artificial intelligence
EMR	electronic medical records
FDA	Food and Drug Administration



FSA	flexible spending account
IADL	instrumental activities of daily living
NLNFNE	National League of Nursing Foundation of Nursing Education
RPM	remote patient monitoring
SCTE	Society of Cable Telecommunications Engineers

## 8. References

- [1] US Census, *The U.S. Joins Other Countries With Large Aging Populations*, available at <https://www.census.gov/library/stories/2018/03/graying-america.html>
- [2] Forbes, *This Marketplace Is Over \$7 Trillion And Rising—Seven New Products And Services This Consumer Will Need From Future Entrepreneurs*, Bernhard Schroeder, May 14, 2020, available at <https://www.forbes.com/sites/bernhardschroeder/2020/05/14/this-marketplace-is-over-7-trillion-and-rising-seven-new-products-and-services-this-consumer-will-need-from-future-entrepreneurs/?sh=4795765b66f2>
- [3] Ian Wheelock, Charles Cheevers, Sudheer Dharanikota, and Ayarah Dharanikota, *Cable Operators for Aging in Place – A Business Case*, SCTE Expo article, 2020, paper available at <https://duketechsolutions.com/cable-operators-for-aging-in-place-a-business-case/>
- [4] Sudheer Dharanikota, Ayarah Dharanikota, Dennis Edens, and Bruce McLoed, *Aging in Place business case for Cable Operators*, SCTE Journal article, June 2021, available at <https://duketechsolutions.com/whitepapers/>
- [5] AARP, *Aging in Place: A State Survey of Livability Policies and Practices, Report by National Conference of State Legislatures and AARP Public Policy Institute*, available at <https://assets.aarp.org/rgcenter/ppi/liv-com/ib190.pdf>
- [6] Task Force on Research and Development for Technology to Support Aging Adults, *Emerging Technologies to Support and Aging Populations*, report available at <https://trumpwhitehouse.archives.gov/wp-content/uploads/2019/03/Emerging-Tech-to-Support-Aging-2019.pdf>
- [7] Seniors Helping Seniors®, *Seniors Helping Seniors® Announces Partnership with Electronic Caregiver™*, August 5<sup>th</sup>, 2020, available at [https://www.franchising.com/news/20200806\\_seniors\\_helping\\_seniors\\_announces\\_partnership\\_with\\_electronic\\_caregiver.html](https://www.franchising.com/news/20200806_seniors_helping_seniors_announces_partnership_with_electronic_caregiver.html)
- [8] TytoCare, *Fletcher students and staff get virtual health care access*, October 5<sup>th</sup>, 2020, available at <https://www.tytoCare.com/news-and-events/fletcher-students-and-staff-get-virtual-health-care-access/>
- [9] Elise Reuter, *Amwell builds on partnership with remote medical exam startup TytoCare*, October 1<sup>st</sup>, 2020, available at <https://medcitynews.com/2020/10/amwell-builds-on-partnership-with-remote-medical-exam-startup-tytocare/?rf=1>

# Achieve Power Savings in a DOCSIS 4.0 network with a Distributed Gain Architecture

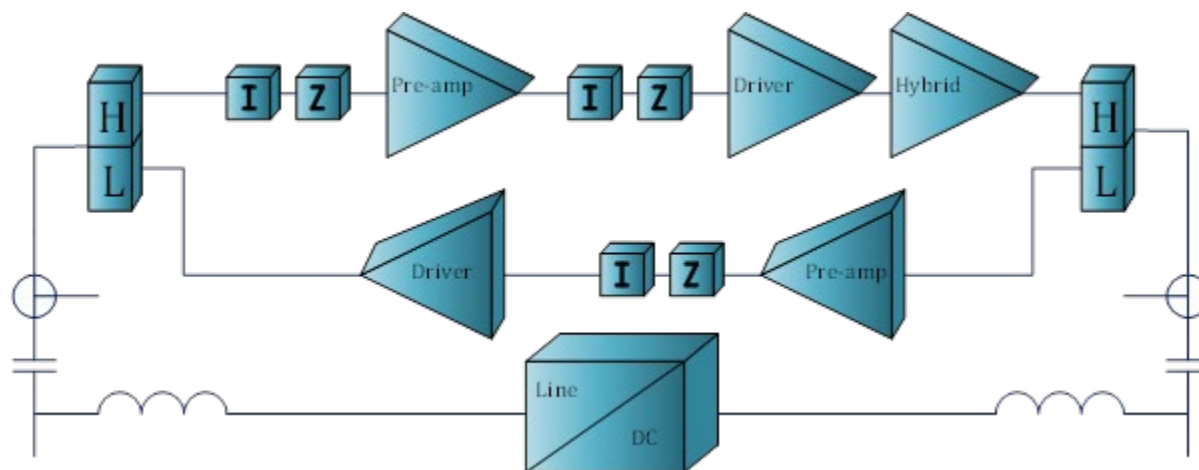
Letter to the Editor prepared for SCTE by

Jan Ariesen, Chief Technology Officer  
Technetix BV  
Kazemat 5, 3905 NR  
Veenendaal, The Netherlands  
[jan.ariesen@technetix.com](mailto:jan.ariesen@technetix.com)

It is a year since CableLabs released the specification for DOCSIS 4.0. The ensuing months have seen a massive increase in demand on residential networks as people work from home and children are being taught remotely because of the pandemic. Consequently, operators are looking at ways to increase network capacity sooner than originally anticipated, particularly in the upstream. The industry proposals currently being promoted rely on upgrading past technologies by continuing to upgrade the signal power outputs of network actives to compensate for the increased cable losses of the higher transmission frequencies. High power results in a less reliable network, higher electrical power consumption and the need for civil engineering to add additional electrical power provision.

One of the main elements of the new DOCSIS 4.0 specification is the ability to expand network capacity to 1.8 GHz, nearly double the capacity of many HFC networks currently. What remains a subject of debate is the best way to meet the specification and how much will it cost? The primary options are extended spectrum DOCSIS (ESD) and full duplex DOCSIS (FDX). Which one do you choose; which is the most futureproof, flexible, and reliable option that will give you more capacity in your network? How much will the chosen solution cost in labor/truck rolls for re-spacing amplifiers and most importantly how much power will it use?

To answer these questions a more detailed examination of the active devices in a network is required to measure how effective an amplifier is using gain versus power consumption. Active devices are used to “gain” the signal making it feasible to transport signals over long distances. These active devices normally consist of the following components:



The signal from the input travels via the power section, test point and diplex filters to the pre-attenuator and pre-equalizer, where the cable can be aligned before reaching the active device. When the signal reaches the pre-amp, it reaches the inter stage where the output signal is aligned to the desired level and tilt. After this stage, the signal gain is in the driver and then finally in the hybrid, giving a last boost to the signal. After the hybrid, the signal goes to the output via the output DPF, test point and power section. From in to out, this amplifier has a downstream gain of 44 dB.

The power supply will create the direct current (DC) signal needed for this device. The efficiency of such a power supply is approximately 75%, meaning that 25% of the power generated is lost in the power supply. The total power consumption of this device is approximately 29 W. A superior amplifier with a more efficient power supply and better gain blocks can reduce power consumption to only 19 W.

In a 1.2 GHz network with 44 dB gain it is possible to overcome loss, but in a 1.8 GHz network the loss is 10-15 dB more, meaning that 44 dB gain is insufficient. In addition, the maximum output power (TCP) a device can deliver is also limited and rendered unfeasible with the addition of 10-15 dB gain.

Four options are available to operators:

**Solution 1: Increased gain and TCP**

With increased power voltage and double the rate of power consumption it is possible to produce approximately 4 dB more gain and 3 dB more TCP. This is a good solution technically and in some scenarios this increased level is enough to reach the next amplifier. However, in most situations an additional 4dB gain and 3 dB TCP will not be enough and creative solutions such as zigzag tilt or lightning bolt tilt will mask the problem but will not solve it. This scenario needs the distance between the actives in the network to be less than in a 1.2 GHz network and respacing is required.

**Solution 2: Respacing**

Respacing the amplifiers solves the problem of not being able to reach the next amplifier, as you physically shorten the distance between the amplifiers, but they must still deliver high levels and high gain to prevent respacing everywhere.

**Solution 3: Booster amplifiers**

These amplifiers make it much easier to reach the next amplifier in a network as amplification increased by this additional booster amplifier. This can be a small amplifier with approximately 20 dB, which will boost the signal enough to reach the next amplifier, it will also ensure that the main amplifiers do not require additional TCP or gain and therefore they will be much more effective.

**Solution 4: Distributed Gain Architecture**

Distributed gain architecture (DGA) makes use of smaller amplifiers with much better level/gain/power efficiency. A small amplifier needs only a few watts to create 20 dB gain, while a high power amplifier (HPA) easily requires 40 watts to create 48 dB gain. The ratio between gain/power in an HPA is  $48/40 = 1.2$  while a DGA using small amplifiers gain/power efficiency is  $20/6 = 3.3$ .

To create 80 dB gain, 80 watts is required for 2 HPA, while with a DGA network 4 small amplifiers are needed using 24 watts. The main difference with a DGA network is that a number of small amplifiers, rather than a few larger amplifiers, are used to create the gain required.

The four solutions are compared by examining 1) the signal quality through the network to the home; 2) the power required to deliver the signal and 3) the reliability of each network.

**Signal quality**

It is impossible for option 1 (increased gain and TCP) to deliver a high-quality signal as there is insufficient gain/level in the network and much of the capacity is lost at a higher frequency.

Option 2 (respacing), option 3 (booster amplifier) and option 4 (DGA) all result in a workable network, as shown below:

Solution	Bits through the network	Bits to the home (k = 1.3)
Option 1 – HPA	8 Gbps	6 Gbps
Option 2 – respacing	10 Gbps	8 Gbps
Option 3 – booster (mid-span ) amplifiers	12 Gbps	9 Gbps
Option 4 – DGA	14 Gbps	11 Gbps

### Power consumption

Power consumption is a big operational expense (OpEx) for MSOs. Network devices are switched on 24/7 and research by SCTE Energy 2020 shows that these devices are responsible for 70% to 80% of the total energy consumption of an operator.

The four solutions give the following power consumption overview:

Solution	Power consumption of an amplifier (1 – 1)	Power consumption for a network with 50,000 HP (including cable loss)
Option 1 – HPA	40 W	84 kW
Option 2 – respacing	40 W	120 kW
Option 3 – booster (mid-span ) amplifiers	19 W plus 6 W	55 kW
Option 4 – DGA	6 W	28 kW

### Reliability

Reliability is measured by Mean Time Between Failure (MTBF) and is a measure of the theoretical lifetime of a product/system. The MTBF is calculated based on components used, temperature of a product, stress on a product and so on. The measure is stated in number of hours.

In this example the MTBF is calculated for approximately 1.6 km (1 mile) of coax.

Solution	Number of amplifiers per mile	MTBF of the solution
Option 1 – HPA	3	25,000 hrs
Option 2 – respacing	4	18,750 hrs
Option 3 – booster (mid-span ) amplifiers	3 MPA plus 3 boosters	33,000 hrs
Option 4 – DGA	7	142,000 hrs

In conclusion, the MTBF of a network built with MPA and booster amplifiers is more than doubled when compared with a network built with HPA amplifiers but the DGA network is by far the most reliable with a MTBF of 142,000 hours.

In this research, four solutions to increase the capacity through the network using DOCSIS 4.0 ESD 1.8 GHz have been compared, using the following criteria:

- Signal quality, what capacity can we get through the network?
- Power consumption, how much power would a network need to deliver signals to 50,000 HP?
- Reliability, how reliable is a network of 1 mile?

Solution	Quality, data capacity to the homes	Power consumption in 50,000 HP network	MTBF of 1 mile network
Option 1: HPA	6 Gbps	84 kW	25,000 hrs
Option 2: respacing	8 Gbps	120 kW	18,750 hrs
Option 3: booster amplifiers	9 Gbps	55 kW	33,000 hrs
Option 4: DGA	11 Gbps	28 kW	142,000 hrs

Based on the numbers above, DGA is by far the most reliable, lowest cost (OpEx) solution and results in the highest improvement in capacity. Another possible solution is to use booster (mid-span) amplifiers – with 50% of the power consumption of HPA and twice the reliability, nearly 10 Gbps can be offered to the end user.

**Abbreviations**

DC	direct current
DGA	distributed gain architecture
ESD	extended spectrum DOCSIS
FDX	Full Duplex DOCSIS
HFC	hybrid fiber coax
HPA	high power amplifier
MTBF	mean time between failures
PON	passive optical network
TCP	total composite power



SCTE STANDARDS  
JOURNAL

**SCTE**  
a subsidiary of CableLabs®

© Society of Cable Telecommunications Engineers, Inc. a subsidiary of Cablelabs 2021.  
140 Philips Road | Exton, PA 19341-1318 | 800.542.5040 | [scte.org](http://scte.org)

